

2008 Acadia, Enclave, Equinox, Lucerne, OUTLOOK, Torrent and VUE Navigation System

Overview	1-1	Navigation Audio System	3-1
Overview	1-2	Navigation Audio System	3-2
Features and Controls	2-1	Voice Recognition	4-1
Features and Controls	2-2	Voice Recognition	4-2
		Index	1-1

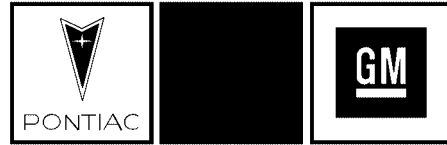

GENERAL MOTORS, GM, the GM Emblem, CHEVROLET, the CHEVROLET Emblem, BUICK, the BUICK Emblem, GMC and the GMC Truck Emblem, PONTIAC, the PONTIAC Emblem, and the names EQUINOX, LUCERNE and TORRENT are registered trademarks; the names ENCLAVE and ACADIA are trademarks of General Motors Corporation.

SATURN, the SATURN Emblem and the name VUE are registered trademarks; the name OUTLOOK is a trademark of Saturn Corporation.



DTS and DTS Digital Surround are registered trademarks of Digital Theater Systems, Inc.



Dolby® is manufactured under license from Dolby® Laboratories. Dolby® and the double-D symbol are trademarks of Dolby® Laboratories.

The information in this manual supplements the owner manual. This manual includes the latest information available at the time it was printed. We reserve the right to make changes in the product after that time without notice. For vehicles first sold in Canada, substitute the name General Motors of Canada Limited for Buick Motor Division, Chevrolet Motor Division, GMC, or Pontiac Division whenever it appears in this manual.

Keep this manual with the owner manual in the vehicle, so it will be there if it is needed. If the vehicle is sold, leave this manual in the vehicle.

Canadian Owners

A French language copy of this manual can be obtained from your dealer/retailer or from:

Helm, Incorporated
P.O. Box 07130
Detroit, MI 48207
1-800-551-4123
www.helminc.com

Propriétaires Canadiens

On peut obtenir un exemplaire de ce guide en français auprès de concessionnaire ou à l'adresse suivante:

Helm Incorporated
P.O. Box 07130
Detroit, MI 48207
1-800-551-4123
www.helminc.com

Section 1 Overview



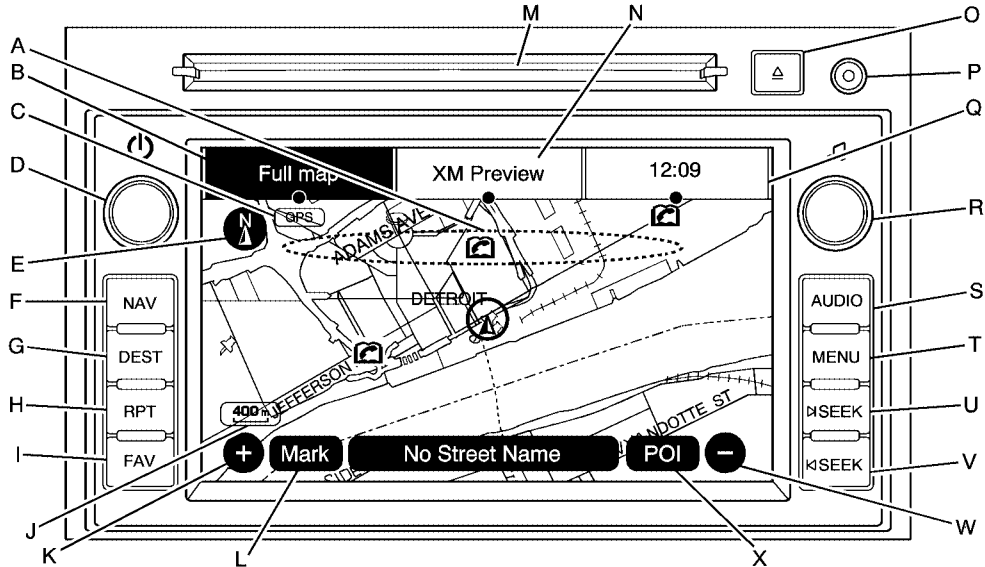

Overview	1-2	Getting Started	1-4
Navigation System Overview	1-2	Cleaning the Video Screen	1-11

Overview

Navigation System Overview



Screen shown with Map Disc Inserted

- A. Map DVD Slot. See “Installing the Map DVD” under *Maps on page 2-4* for more information.
- B. FULL MAP Touch Screen Button. See “NAV” under “Hard Keys” under *Using the Navigation System on page 2-2* for more information.
- C. No GPS Symbol. See *Symbols on page 2-7* for more information.
- D.  (Power/Volume) Knob. See *Navigation Audio System on page 3-2* for more information.
- E. North Up/Heading Up Symbol. See *Symbols on page 2-7* for more information.
- F. NAV (Navigation) Key. See “Hard Keys” under *Using the Navigation System on page 2-2* for more information.
- G. DEST (Destination) Key. See *Destination on page 2-14* for more information.
- H. RPT (Repeat) Key. See “Hard Keys” under *Using the Navigation System on page 2-2* for more information.
- I. FAV (Favorite) Key. See “Storing Radio Station Presets” under *Navigation Audio System on page 3-2* for more information.
- J. Map Scale. See “Map Scales” under *Maps on page 2-4* for more information.
- K.  (Zoom In) Touch Screen Button. See “Map Scales” under *Maps on page 2-4* for more information.
- L. Mark Touch Screen Button. See “Adding Destinations to the Address Book” under *Destination on page 2-14* for more information.
- M. CD/DVD Slot. See *CD Player on page 3-10* or *DVD Player on page 3-17* for more information.
- N. Source (AM, FM, XM, CD, etc.) Touch Screen Button. See *Navigation Audio System on page 3-2* for more information.
- O.  (CD/DVD Eject) Key. See “Hard Keys” under *Using the Navigation System on page 2-2* for more information.
- P. Auxiliary Jack. See *Auxiliary Devices on page 3-24* for more information.
- Q. Clock Touch Screen Button. See “Setting the Clock” under *Configure Menu on page 2-29* for more information.
- R.  (Tune/Sound) Knob. See *Navigation Audio System on page 3-2* for more information.
- S. AUDIO Key. See *Navigation Audio System on page 3-2* for more information.
- T. MENU Key. See *Configure Menu on page 2-29* for more information.

- U. ▷ SEEK Key (Next). See *Navigation Audio System on page 3-2* for more information.
- V. ◀ SEEK Key (Previous). See *Navigation Audio System on page 3-2* for more information.
- W. ● (Zoom Out) Touch Screen Button. See “Map Scales” under *Maps on page 2-4* for more information.
- X. POI (Point of Interest) Touch Screen Button. See “Displaying Points of Interest (POI) on the Map Screen” under *Symbols on page 2-7* for more information.

Getting Started

Before operating the navigation system, read this manual to become familiar with its operation.

While entering the vehicle or when turning the vehicle off, some DVD Map Disc noise is normal.

Keeping your mind on the drive is important for safe driving. See “Defensive Driving” in the Index of your vehicle’s owner manual for more information.

The navigation system includes navigation and audio functions.

While the vehicle is parked:

- Familiarize yourself with all of its controls.
- Familiarize yourself with its operation.
- Set up your audio by presetting your favorite stations, setting the tone, and adjusting the speakers.
- Set up the navigation features that can only be done before you begin driving.

A destination or alphanumeric text can only be entered when the vehicle is in PARK (P). The touch-sensitive screen buttons leading to the alphanumeric keyboard are not lit while driving.

Not all functions are available while driving. They appear grayed out on the screen. All functions are available when parked. Some functions can be performed while driving, as long as you can do so without diverting too much of your attention from your driving.

 **CAUTION:**

This system provides you with a far greater access to audio stations and song listings. Giving extended attention to entertainment tasks while driving can cause a crash and you or others can be injured or killed. Always keep your eyes on the road and your mind on the drive — avoid engaging in extended searching while driving.

 **CAUTION:**

Looking at the moving map on the navigation screen frequently or for too long while driving can cause a crash and you or others can be injured or killed. Keep your eyes and mind on the road and avoid looking too long or too often at the moving map on the navigation screen. Use the voice guidance directions whenever possible.

The navigation system lets you:

- Plan a route with provided turn-by-turn route and map guidance with voice prompts.
- Select a destination using various methods and choices.
- Receive RDS broadcast announcements.

Always be alert and obey traffic and roadway laws and instructions, regardless of the guidance from the navigation system. The navigation system uses street map information that does not include all traffic restrictions or the latest road changes; it may suggest using a road that is now closed for construction or a turn that is prohibited by signs at the intersection. The system uses limited information. Always evaluate whether following the system's directions is safe and legal for the current conditions.

CAUTION

Remember, if you are distracted while driving, you could cause a crash and you or others could be injured or killed.

Before using this system while driving, read the owner's manual and learn how the system operates.

Always concentrate on your driving first by keeping your eyes and mind on the road, and your hands on the wheel.

Some function of this system will not operate when the car is moving. See owner's manual for more information.

OK

Every fifty times the vehicle is started and the navigation system is turned on, the Caution screen appears. After reading the caution, select OK to load the map DVD information. If OK is not selected, all hard keys except for NAV (Navigation) and DEST (Destination) can be accessed. You can also press the NAV hard key to have this Caution screen appear.

When getting started, set the navigation system to your preference or delete information you may have entered using various options.

Language

For vehicles with a Driver Information Center (DIC), see "DIC Vehicle Customization" in the Index of your vehicle's owner manual to change the language of the navigation screens.

For vehicles without a Driver Information Center (DIC), the radio can be used to change the language of the navigation screens:

1. Press the  (power) knob to turn the system on.
2. Press the MENU hard key and select the Display screen button.
3. Select the language; English, Francais, Espanol.

English/Metric Units



To change the navigation screens from English or metric, see "DIC Operation and Displays" in the Index of your vehicle's owner manual.

Deleting Personal Information

This navigation system can record and store personal information such as names and addresses. It is recommended that stored personal information is deleted when disposing the vehicle. See “Edit Address Book — Edit/View” under *Configure Menu on page 2-29* for deleting information from the address book.

Storing Radio Station Presets

To set preset radio stations:

1. Press  to turn the system on.
2. Press the AUDIO hard key and select the desired band (AM, FM1, FM2, XM1, or XM2 (if equipped)).
3. Use the  (tune) knob or the SEEK arrows to go to the desired station.
4. Press and hold one of the five preset screen buttons, at the bottom of the screen, until a beep is heard or see the station displayed on the selected preset button.
5. Repeat the steps for each preset.

See “Storing Radio Station Presets” under *Navigation Audio System on page 3-2* for more information.

Setting the Clock

1. Press  to turn the system on.
2. Press the MENU key to enter the configure menu options, then press the MENU key repeatedly until the time is selected or select the time screen button.
3. Press the Set screen button.
4. Press the Hours and Minutes – (minus) and + (plus) signs to decrease or to increase the time.

See “Setting the Clock” under *Configure Menu on page 2-29* for more information.

Entering an Address and Point of Interest, and Storing Preset Destinations



Entering an Address

To enter a destination by entering the city name first:

1. If the radio is on with a map disc inserted, skip to Step 5.
2. Press  to turn the system on.
3. Insert the DVD map disc. See “Installing the Map DVD” under *Maps on page 2-4* for more information.
4. A caution may appear. Select the OK screen button to proceed.



5. Press the DEST hard key.
 6. Select the  Address Entry screen button.
 7. Select the state/province screen button, if needed, to change the current state or province.
 - Enter the name or enter the two-letter abbreviation. A list displays.
 - Another way is to select the List screen button and then, select the state or province.
 8. Select the City name button and start entering the city name.
 - If five or less names are available, a list displays.
 - If more than five are available, the List screen button will have a number in it that represents the number of available cities. Select this button to view the list and select a city.
 9. Once a city has been selected, the Street name category is automatically selected for entry.

Do not enter directional information or street type.

Use the space symbol screen button () between street or city names. For example, the street name N. Royal Oak Rd. should be entered as royal  oak. Use the backspace () screen button if an incorrect character has been entered.
 - If five or less streets are available for the selected city, the system displays the list of streets.
 - If more than five streets are available the system displays the alpha keyboard. Start entering the street name. If five or less names are available, a list displays. If more than five are available, the List screen button will have a number in it that represents the number of available streets. Select this button to view the list and select a street.
 10. Once a street has been selected, select the House # screen button to enter the house number. The system displays the house number range that is available for the street.
 11. Select the Go screen button. A map screen, with the destination marked appears.
 12. Select the route preference (Fastest, Shortest, or Other). The system calculates and highlights the route.
 13. Select the Start Guidance screen button. The route can now be started.
- See “Address Entry ” under *Destination on page 2-14* for more information.

Entering a Point of Interest (POI)

To set a destination by entering a Point of Interest (POI):

1. If the radio is on with a map disc inserted, skip to Step 5.
2. Press  to turn the system on.
3. Insert the DVD map disc. See “Installing the Map DVD” under *Maps on page 2-4* for more information.
4. A caution may appear. Select the OK screen button to proceed.
5. Press the DEST hard key.
6. Select the  Point of Interest screen button.
7. Select the state/province screen button, if needed, to change the current state or province.
 - Enter the name or enter the two-letter abbreviation. A list displays.
 - Select the List screen button and select the state or province.
8. Enter the specific title of the POI in the POI name space (i.e. Washington Monument).
 - If five or less names are available, a list displays.
 - If more than five are available, the List screen button will have a number in it, it represents the number of available POIs. Select this button to view the list.
9. Select the Go screen button next to the POI. A map screen, with the destination marked appears.
10. Select the route preference (Fastest, Shortest, or Other). The system calculates and highlights the route.
11. Select the Start Guidance screen button. You are now ready to start your route.

See “Point of Interest (POI)” under *Destination on page 2-14* for more information.

Storing Preset Destinations

1. If the radio is on with a map disc inserted, skip to Step 5.
2. Press  to turn the system on.
3. Insert the DVD map disc. See “Installing the Map DVD” under *Maps on page 2-4* for more information.
4. A caution may appear. Select the OK screen button to proceed.
5. Press the DEST hard key.

Enter a destination. See *Destination on page 2-14* for more information on how to enter a destination.
6. Select the Map screen button after entering the destination.
7. Select the Mark screen button from the map. The address book screen appears.

8. Select the Name screen button. An alpha-keyboard displays. Enter the name.
9. Press and hold one of the screen buttons at the bottom of the screen until the name appears in the screen button on the display.

The name appears in that preset destination screen button and is now available to select from the Destination Entry screen. See “Using Your Stored Preset Destinations” next in this section to select it as a destination.

See “Adding or Changing Preset Destinations” under *Destination on page 2-14* for more information on how to add preset destinations.

Using Your Stored Preset Destinations

These destinations are available for selection while driving.

1. If the radio is on with a map disc inserted, skip to Step 5.
2. Press  to turn the system on.
3. Insert the DVD map disc. See “Installing the Map DVD” under *Maps on page 2-4* for more information.
4. A caution may appear. Select the OK screen button to proceed.

5. Press the DEST hard key.
6. Select one of the available preset destination screen buttons. A map screen, with the destination marked appears.
7. Select the route preference (Fastest, Shortest, or Other). The system calculates and highlights the route.
8. Select the Start Guidance screen button. The route can now be started.

See “Preset Destination” under *Destination on page 2-14* for more information.

Canceling Guidance

Guidance is canceled once you arrive at your final destination. To cancel guidance prior to arrival at the final destination:

1. Press the DEST hard key.
2. Select the Cancel Guidance screen button.
3. A pop-up confirmation appears. Select OK to cancel guidance or Cancel to cancel the request.

Guidance Volume

To adjust the volume of voice guidance prompts:

1. Press the MENU hard key to enter the menu options, then press the MENU key repeatedly until Nav is selected or select the Nav screen button.
2. Select the Voice Prompt screen button.
3. Select the On screen button if voice guidance is not on.
4. Select the + (plus) or – (minus) screen buttons to increase or to decrease the volume of the voice prompts. The system responds with the adjusted voice level.

See “Voice Prompt ” under *Configure Menu on page 2-29* for more information.

Turning the  (volume) knob during a voice or navigation prompt will also change the volume.

Cleaning the Video Screen

Use a soft clean cotton cloth dampened with clean water.

Section 2 Features and Controls

Features and Controls	2-2	Global Positioning System (GPS)	2-40
Using the Navigation System	2-2	Vehicle Positioning	2-41
Maps	2-4	Problems with Route Guidance	2-42
Symbols	2-7	If the System Needs Service	2-43
Destination	2-14	Ordering Map DVDs	2-43
Configure Menu	2-29	Database Coverage Explanations	2-43
Rear Vision Camera	2-36		

Features and Controls

Using the Navigation System



This section includes basic information to operate the navigation system.

Use the hard keys and the touch-sensitive screen buttons on the navigation screen to operate the system. See *Navigation System Overview on page 1-2* for more information.

Once the vehicle is moving, some functions become disabled to reduce driver distractions.

Hard Key Operation

(Power/Volume):

- Press to turn the system on and off.
- Turn to increase or decrease the volume to the audio system.
- Press and hold  for more than two seconds to turn off the navigation system, the Rear Seat Entertainment (RSE), and Rear Seat Audio (RSA). If the vehicle has not been turned off, the RSE and the RSA can be turned back on by pressing  and continues playback of the last active source.

(Tune/Speaker Adjustment):

- Press  to access the Sound screen to adjust bass, midrange, treble, and equalization.
- Turn to go to the next or previous radio station. See *Navigation Audio System on page 3-2* for more information.

(CD/DVD Eject): Press to eject CDs and DVDs.

NAV (Navigation):

- Press to view your vehicle's current position on the map screen.
- Press multiple times to cycle through Full Map and the tab that displays the current audio source (AM, FM, CD, etc.). Full Map displays the screen in full map view.
- Select the audio tab to split the screen between the map screen and the current audio source screen menu. See "Audio" under *Navigation Audio System on page 3-2* for more information.

DEST (Destination): Press to access the Destination Entry screen to plan a destination. See *Destination on page 2-14* for more information.

RPT (Navigation Repeat): Press to repeat the last voice guidance prompt.

FAV (Favorite): Press to access the preset stations. See “Storing Radio Station Presets” under *Navigation Audio System on page 3-2* for more information.

AUDIO: Press to access the full Audio screen to change AM, FM, XM™ Satellite Radio Service (if equipped), CD, DVD, if equipped, and auxiliary input. See “Audio” under *Navigation Audio System on page 3-2* for more information.

MENU: Press to adjust features for sound, radio, navigation, the display, and for adjusting the time. See *Configure Menu on page 2-29* for more information.

▷ SEEK / ◀ SEEK: Press either arrow to seek and scan radio stations, to seek tracks on a CD, or to seek chapters on a DVD, if equipped. See *Navigation Audio System on page 3-2*, *CD Player on page 3-10*, or *DVD Player on page 3-17* for more information.

Touch-Sensitive Screen Buttons

These buttons are located on the screen. When selected, a beep will sound. Screen buttons are highlighted when a feature is available.

Alpha-Numeric Keyboard

Letters of the alphabet, symbols, punctuation, and numbers, when available, display on the navigation screen as an alpha or numeric keyboard. The alpha keyboard displays when the system requires entry of a city or street name.

All characters are touch-sensitive screen buttons. Touch a character to select it.

A-Y (Accent Alphabet): Select to get letters with accent symbols. This button may toggle to A-Z.

A-Z (Alphabet): Select to get letters from the alphabet. This button may toggle to A-Y.

0-9 (Numbers): Select to get numbers and punctuation marks.

␣ (Space): Select to enter a space between characters or the words of a name.

Backspace: Select if an incorrect character has been entered.

To make name selections easier, the system only highlights the characters that can follow the last one entered. For example, if a Z is entered, a T may not be available for selection.

If a name does not display after entry, it may need to be entered differently or the map DVD disc may not contain that information. See *Database Coverage Explanations on page 2-43* for more information.

Maps

This section includes basic information about the map database.

Map Coverage

The maps are stored on a DVD. The United States, Canada, Puerto Rico, and the U.S. Virgin Islands are contained on one disc.

Refer to the “Navigation System Map Disc” manual for a detailed explanation of map coverage and detailed city lists in each region. This manual is in the map DVD case when the vehicle is delivered from the factory.

Installing the DVD Map Disc

Your dealer/retailer may have installed the map DVD. If the map DVD was not installed, do the following to load it:

Read the following steps completely.

1. Turn the ignition on. Your vehicle must be in PARK (P) to perform this operation.
2. Press  (power) to turn the navigation system on.
3. Press the NAV hard key.
4. Touch the Insert Map Disc screen button. The screen opens to access the map DVD slot.

5. Load the map DVD partway into the slot. The system pulls it in.

The screen cannot be closed until a double beep is heard.

Notice: Pressing directly on the navigation screen may cause damage. Repairs would not be covered by your warranty. Do not press directly on the navigation screen.

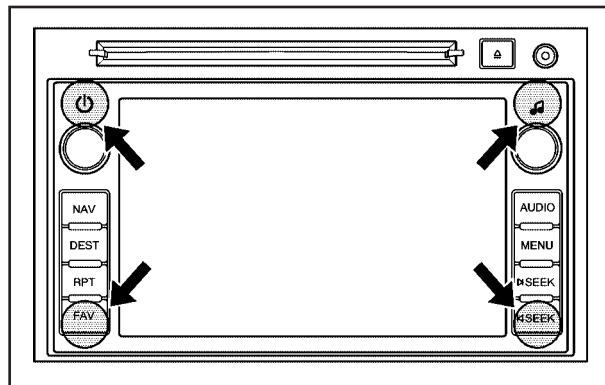

6. To close the screen, slightly push up on the two outer corners until the screen is in position. Then push the screen in by pushing on the four outer corners until you hear a click.

Ejecting the DVD Map Disc

The navigation portion of the system cannot be used if the DVD map disc is not loaded.

1. Press the MENU key to enter the Menu options, then press the MENU key repeatedly until Nav is selected or touch the Nav screen button.
2. Touch the Map Database Information screen button.
3. Touch the Eject Map Disc screen button. The screen tilts, exposing the map DVD slot.
4. Press the eject button, located next to the DVD map disc slot, and the disc ejects. Pull the disc out.
The screen cannot be closed until a double beep is heard.

Notice: Pressing directly on the navigation screen may cause damage. Repairs would not be covered by your warranty. Do not press directly on the navigation screen.

5. To close the screen, slightly push up on the two outer corners until the screen is in position. Then push the screen in by pushing on the four outer corners until you hear a click.

Handling the DVD Map Disc

To properly handle the DVD map disc:

- Handle the disc very carefully to avoid contamination or flaws. Signals may not read out properly if the disc gets contaminated or flawed.
- Do not use photographic record cleaner, solvents, or other cleaners if the disc gets soiled. Use a soft cloth to gently wipe it out from the center of the disc to the outside.
- Do not use the disc to rest on while writing or drawing with any writing utensil. Do not attach a seal to the disc.
- Do not keep the disc in direct sunlight, high temperatures, or humidity.
- After using the disc, place it back into the original case.

Map Adjustments

The system lets you adjust the scale of view on the map. Also, as you drive, the map scrolls automatically based on the direction of travel.

Map Scales

⊕ / ⊖ (Zoom In/Zoom Out):

- Touch the zoom in or out screen buttons or the scale on the bar to change the level of map detail. The scale appears on the screen once the zoom in or zoom out screen buttons are selected. The system adjusts the map accordingly. The scale of a map can range from 1/32 mi. (50 m) to 256 mi. (400 km).
- See “Driver Information Center, DIC Controls and Displays” in the Index of your vehicle’s owner manual to change between English or metric.

Scrolling the Map

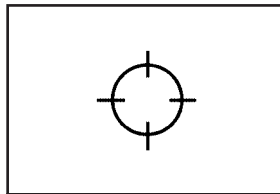

Touch anywhere on the map screen and the scroll symbol appears. Use this feature to scroll across the map.

- Move your finger in any direction on the map screen and the map continues to scroll in that direction.
 - If scrolling while your vehicle is in PARK (P), the system initially scrolls at a slower rate. The scroll speed increases if you continue touching the map screen.
 - If scrolling while your vehicle is in motion, there is one scroll speed and the distance is limited. You have to keep touching the map screen to scroll for a longer distance.
- Press the NAV (Navigation) key to return to the current vehicle location on the map if your vehicle icon disappears from the screen.

- Use the scroll feature on the map to set a destination. See “From Map” under *Destination* on page 2-14 for more information.
- Press the GO screen button to calculate the route from your current position to the destination mark, while scrolling on the map without a planned route.

Symbols

The following symbols are the most common symbols that appear on a map screen.

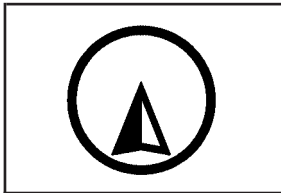

Your vehicle is shown as this symbol. It indicates the current position and the direction your vehicle is traveling on the map.

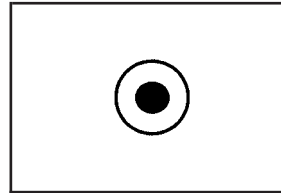

The destination symbol appears on the map, after a route has been planned, marking the final destination.

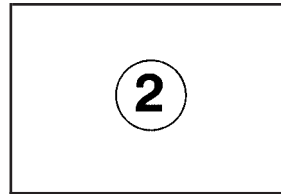

The stopover symbol displays on the map after a stopover has been added to the route.

The stopover symbols are numbered one through three, depending on how many stopovers have been set.

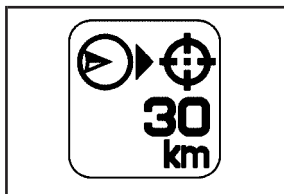

The distance to destination symbol indicates the distance to the final destination.

This symbol appears when the time to the destination is not available or while you are scrolling on the map.



The distance and time to destination symbol indicates the distance and the estimated time remaining to your final destination, depending on the option selected.

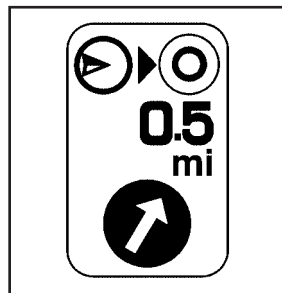

The straight line to distance symbol indicates the straight-line distance to your destination.

This symbol appears before you start driving on the route or if you are on a road where navigation guidance cannot be given.

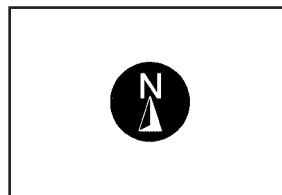

The north up symbol indicates the map with North Up, known as North Up mode.

While in North Up mode, the vehicle icon follows the north direction on the map regardless of which direction the vehicle is traveling. Select this screen symbol to switch between North Up, Heading Up, and 3-D view modes.

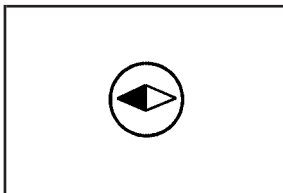

The heading up symbol indicates that the vehicle is traveling up on the map and is known as Heading Up mode.

The shaded triangle indicates the North direction. While in Heading Up mode the direction at the top of the screen and the way the vehicle icon is heading indicates the direction your vehicle is traveling. Select this screen symbol to switch between Heading Up, North Up, and 3-D view modes.

Three-dimensional (3-D) view mode changes the appearance of the map display to a road level view.

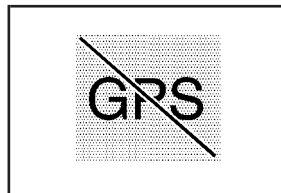

The No GPS symbol appears when your vehicle is acquiring or not receiving a Global Positioning System (GPS) satellite signal.

See *Global Positioning System (GPS)* on page 2-40 for more information.



Select the Mark screen button to store the location on the screen in your address book.

The system automatically stores the point in the address book. See “Adding Destinations to the Address Book” under *Destination* on page 2-14 for more information.

Displaying Points of Interest (POI) on the Map Screen

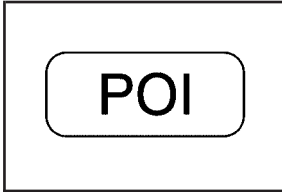

Select the POI screen button to display or delete POI icons from the map.

Displaying POI icons on the map lets you know where POIs (e.g. restaurants, gas stations, etc.) are located. This screen appears after selecting the POI screen button.

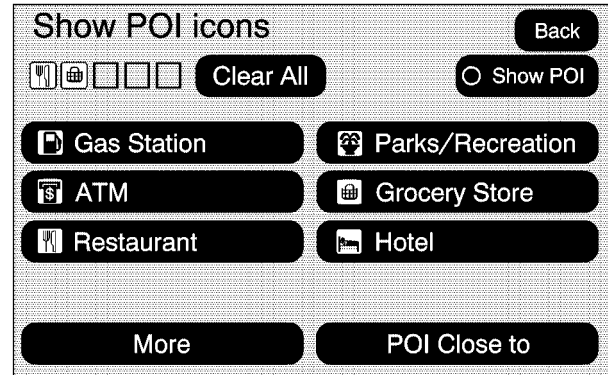

1. Select one of the POI categories to display or to delete POI icons from the map screen. Once a category has been selected the POI icon displays at the top of the screen.
2. Select up to five categories to display on the map screen. When a category is selected those POI icons display on the map.
3. Press the POI screen button again to add more POI icons.

More: Select to view more POI categories.

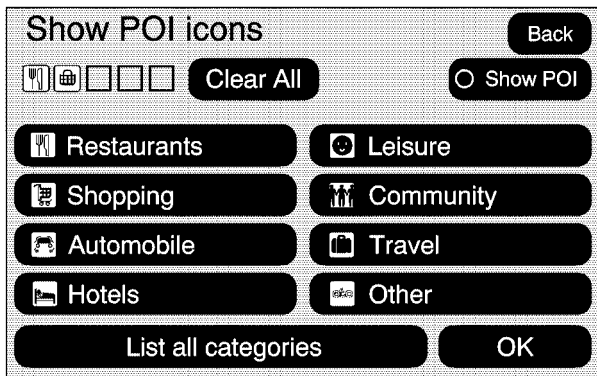

POI Close to:

1. Once a category has been selected, touch this button to display the list of available POIs for the selected POI categories. The list provides the POI icon, the name, the direction, and the distance to the POI from your vehicle's current position.
2. Use the scroll arrows to move up and down the list.
3. Use the sorting screen buttons: Dist (distance), Icon, Name, and on Route as needed.

Go: Select this screen button, next to the desired POI, to make this POI a destination or a stopover.

Select a POI name to receive information about the POI. From this screen you can select: Address Book, Go, or Map.

Address Book: Press to add this POI to the address book. See "Nav" under *Configure Menu on page 2-29* for information on editing address book entries.

Go: Select to make this POI a destination or a stopover.

Map: Select to display the map showing the location of the POI.

OK: Select to display the map screen.

Show POI: Select to display or remove the POI icons from the map screen.

List all Categories: Select to list all POIs sorted alphabetically.

Delete: To delete a specific POI category, select the category.

Clear All: Select this screen button to clear all selected POI categories.

Driving on a Route

When a destination has been routed and you are driving on route, the map screen automatically displays the next maneuver.



The pop-up displays the next maneuver direction and how many miles or kilometers you are from it.

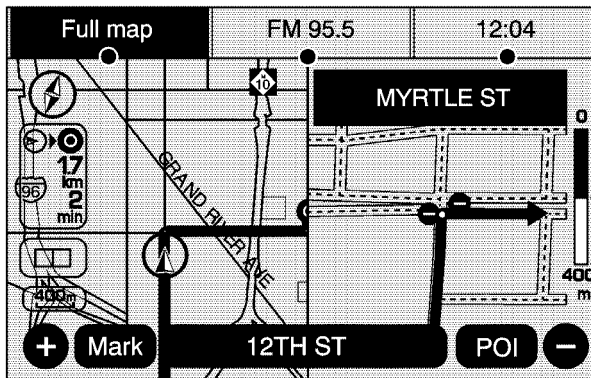

When you are approximately 1/4 mi (400 m) from the next maneuver, the screen displays the name and a detailed view of the next maneuver.

3-D Lane Guidance

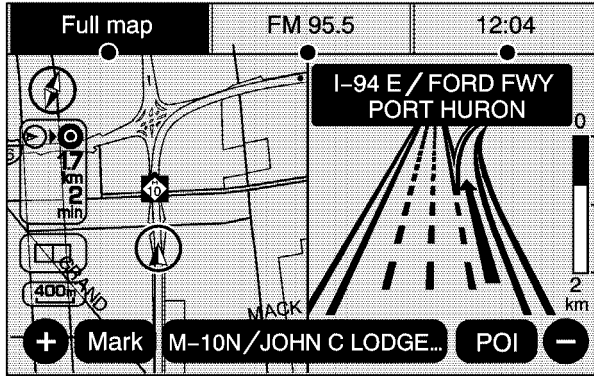

Some major metropolitan areas may include a 3-D lane guidance feature for highway exits and junctions. This feature gives you a more vivid representation of the exits and junctions on your route. Cities that include this feature are New York, Los Angeles, Chicago, Detroit, and San Francisco, and may also include Philadelphia, Washington D.C., and other major highway junctions.

Dual Mode

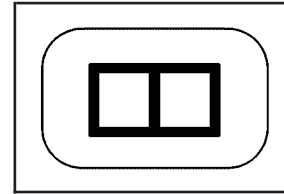

This dual screen symbol displays when the screen is in dual mode.

Dual mode displays the route on half of the screen and a maneuver or turn list on the other half. Press this button to switch between dual screen and full screen which displays the entire route.

Auto Reroute

When your destination is set and you are off the planned route, the system automatically plans a new route and begins to reroute. The new route is highlighted on the screen.

Destination

To Use the destination feature on the navigation system:

1. Press the DEST key to access the Destination Entry screen.
2. Select one of five destination options from this screen.

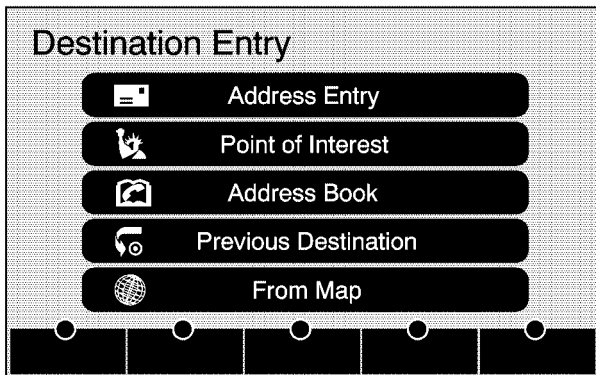

Address Entry

 **Address Entry:** Enter an address by providing the system with a city name or a street name.

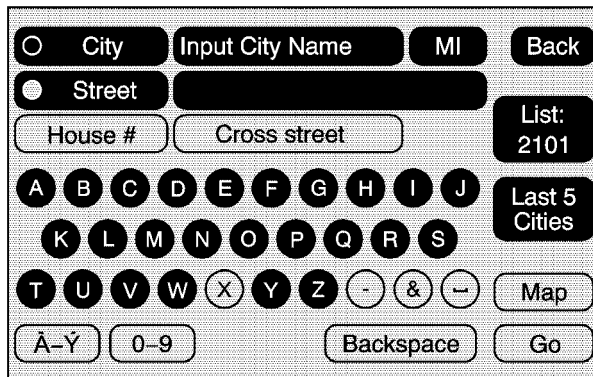

Enter the city name first:

1. Press the DEST hard key.
2. Select the  Address Entry screen button.
3. Select the state/province screen button, if the current state or province needs to change.
 - Enter the name or enter the two-letter abbreviation. A list displays.
 - Another way to select a state is to select the List screen button, then select the state or province.

4. Select the City name button.
 - Enter the City Name or select the Last 5 Cities screen button. The Last 5 Cities screen displays a list of the last five city names that had been entered.
 - Select a city from the list and it appears in the City name area.
5. If using the alpha keyboard, finish entering the city name. If four or less names are available, a list displays. If more than four are available, a number appears in the List screen button. This number represents the number of available cities.
 - Select this button to view the list.
 - Select a city.
6. Once a city has been selected the Street name category is automatically selected for entry.

Start entering the street name. If five or less names are available, a list displays. If more than five are available, a number appears in the List screen button. This number represents the number of available streets.

- Select this number to view the list.
- Select a street name.

7. Once a street has been selected, select the House # screen button to enter the house number. The system displays the house number range that is available for the street. Select a house number.
8. Select the Go screen button. The map screen displays with the destination marked.
9. Select the route preference (Fastest, Shortest, or Other). The system calculates and highlights the route.
10. Select the Start Guidance screen button. The route can now be started.
See “Getting Started on Your Route” later in this section for more information.

To enter a destination by entering the street name first:

1. Press the DEST hard key.
2. Select the  Address Entry screen button.
3. Select the state/province screen button, if the current state or province needs to change.
 - Enter the name or enter the two-letter abbreviation. A list displays.
 - Another way to enter a state is to select the List screen button, then select the state or province.

4. Select the Street screen button.
 - Enter the street name. The Last 5 Streets screen displays a list of the last five street names that had been entered.
 - Select a street from the list and it appears in the Street name area.
5. If using the alpha keyboard, finish entering the street name. If five or less names are available, a list displays. If more than five are available, a number appears in the List screen button. This represents the number of available streets.
 - Select this button to view the list.
 - Select a street.
6. Once a street has been selected, select the House # screen button to enter the house number. The system displays the house number range that is available for the street. Select the house number.
7. Select the Go screen button. The map screen displays with the destination marked.
8. Once the house number is selected, the city name automatically populates. If there is more than one city available for selection, a list of cities displays. Select the city.
9. Select the route preference (Fastest, Shortest, or Other). The system calculates and highlights the route.

10. Select the Start Guidance screen button. The route can now be started.
See “Getting Started on Your Route” later in this section for more information.

To enter a destination by entering a cross street:

1. Press the DEST hard key.
2. Select the  Address Entry screen button.
3. Select the state/province screen button, if needed, to change the current state or province.
 - Enter the name or enter the two-letter abbreviation. A list displays.
 - Another way to enter a state is to select the List screen button, then select the state or province.
4. Select the City or Street screen button.
The Last 5 Cities or Streets screen button displays a list of the last five city or street names that had been entered. Select a city or street from the list and it appears in the City or Street name area.
If using the alpha keyboard, finish entering the city or street name. If five or less names are available, a list displays. If more than five are available, a number appears in the List screen button. This represents the number of available cities or streets.
 - Select this button to view the list
 - Select a city or street.

5. Once a city and a street have been selected, touch the Cross Street screen button and start entering the cross street name. If five or less names are available, a list displays. If more than five are available, a number appears in the List screen button. This represents the number of available streets.
 - Select this button to view the list.
 - Select a street.
6. Select the Go screen button. The map screen displays with the destination marked.
7. Select the route preference (Fastest, Shortest, or Other). The system calculates and highlights the route.
8. Select the Start Guidance screen button. The route can now be started.
See “Getting Started on Your Route” later in this section for more information.

Point of Interest (POI)

The Point of Interest (POI) destination entry method lets you select a destination from the POI list.

Point of Interest:

1. Select this screen button to access the POI (Point of Interest) screen. From this screen you have two options to select/enter a destination.
2. Either enter the name using the alpha keyboard or select a category from the category list.

To use the point of interest destination entry method by entering the name:

1. Press the DEST hard key.
2. Select the  Point of Interest screen button.
3. Select the state/province screen button, if needed, to change the current state or province.
 - Enter the name or enter the two-letter abbreviation. A list displays.
 - Another way to select a state is to select the List screen button, then select the state or province.
4. Enter the POI name.

If four or less names are available, a list displays. If more than four are available, a number appears in the List screen button. This represents the number of available POIs. Select this button to view the list.

5. Select the Go screen button next to the POI. The map screen displays with the destination marked.
6. Select the route preference (Fastest, Shortest, or Other). The system calculates and highlights the route.
7. Select the Start Guidance screen button. The route can now be started.
See “Getting Started on Your Route” later in this section for more information.

To use the point of interest destination entry method by selecting a category:

1. Press the DEST hard key.
2. Select the  Point of Interest screen button.
3. Select the Browse POI Categories screen button to view the list of POI categories.
4. Select a category, and then a sub-category. The system displays available POI names in the selected sub-category.
 - Select the POI, or once the Browse POI Categories button is selected, a List All Categories screen button displays.
 - Select this button to view a list of all categories.
 - Select one of the categories and a list of all locations for the selected category for a particular area displays.
 - Select the location.
5. Select the Go screen button next to the POI. The map screen displays with the destination marked.
6. Select the route preference (Fastest, Shortest, or Other). The system calculates and highlights the route.
7. Select the Start Guidance screen button. The route is now ready to be started.

See “Getting Started on Your Route” later in this section for more information.

Address Book

The address book entry method lets you select a destination by selecting an address that has been stored in your address book.

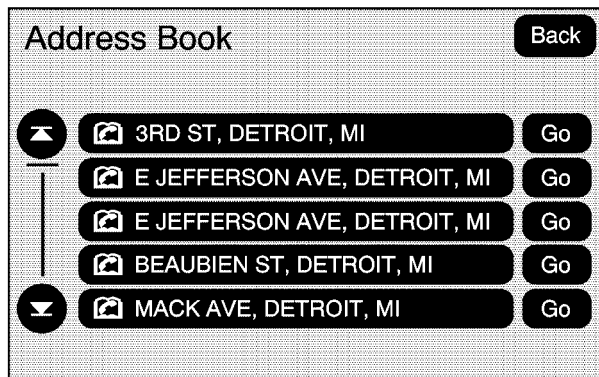

 **Address Book:** Select this screen button to access the Address Book screen. From this screen you can select an address that already exists as the destination.

To use the address book entry method:

1. Press the DEST hard key.
2. Select the  Address Book screen button.
A list of your address book addresses display. Use the arrows on the left side of the screen to scroll through the list.
3. Select the Go screen button next to the destination. The map screen displays with the destination marked displays.
4. Select the route preference (Fastest, Shortest, or Other). The system calculates and highlights the route.
5. Select the Start Guidance screen button. The route can now be started.
See “Getting Started on Your Route” later in this section for more information.
See “Adding Destinations to the Address Book” later in this section.

Previous Destination

The previous destination entry method lets you select a destination from a list of previous destination points.



To use the previous destination entry method:

1. Press the DEST hard key.
2. Select the  Previous Destination screen button.
3. Select a previous destination from the list. Use the scroll arrows to the left to scroll through the list.
4. Select the Go screen button next to the destination. The map screen displays with the destination marked.
5. Select the route preference (Fastest, Shortest, or Other). The system calculates and highlights the route.
6. Select the Start Guidance screen button. The route can now be started.
See “Getting Started on Your Route” later in this section for more information.

 **Previous Destination:** Select this screen button to access the Previous Destination screen. The system stores up to 20 points that have been previously entered. As new destinations are entered, the system automatically deletes the oldest destinations and adds the new destinations.

From Map



This destination entry method lets you select a destination by scrolling on the map.



 **From Map:** Select this screen button to enter the From Map destination entry method.

To use this destination entry method:

1. Press the DEST hard key.
2. Select the  From Map screen button. A map screen displays with the scrolling symbol.

3. Use the  /  (**zoom in/out**) screen buttons and touch on the map to find the area to be selected as your destination.

Pressing, holding, and dragging your finger on the map activates fast scrolling.

4. Touch once on the area that is to be set as your destination.

The map screen displays the address information.

5. Select the Go screen button. The map screen displays with the destination marked.
6. Select the route preference (Fastest, Shortest, or Other). The system calculates and highlights the route.
7. Select the Start Guidance screen button. The route can now be started.

See “Getting Started on Your Route” later in this section for more information.

Map Coordinates

The coordinates destination entry method lets you select a destination by entering latitude and longitude coordinates.

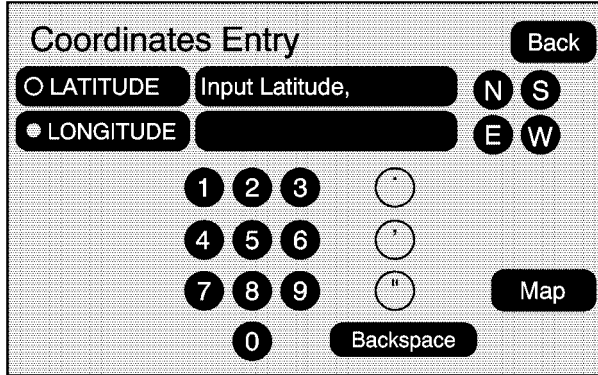

Map Coordinates: Select this screen button to access the Coordinates Entry screen.

To use the coordinates destination entry method:

1. Press the DEST hard key.
2. Select the From Map screen button.
3. Select the Map Coordinates screen button.

4. Select Latitude and select either N (north) or S (south) to enter the direction of the latitude coordinate. Enter the numeric portion of the latitude coordinate.
 5. Select Longitude and select either E (east) or W (west) next to enter the direction of the longitude coordinate. Enter the numeric portion of the longitude coordinate.
 6. Once both coordinates are entered, select the Go screen button. The map screen displays with the destination marked.
 7. Select the route preference (Fastest, Shortest, or Other). The system calculates and highlights the route.
 8. Select the Start Guidance screen button. The route can now be started.
- See “Getting Started on Your Route” later in this section for more information.

Preset Destination

The preset destination entry method lets you set a destination from one of five previously stored destinations. Besides voice tagged destinations, these are the only destinations available to set while the vehicle is moving. If a destination is not set for one of the screen buttons, the button will be dim and will not be available for use. See “Adding or Changing Preset Destinations” later in this section for information on how to add a preset destination.

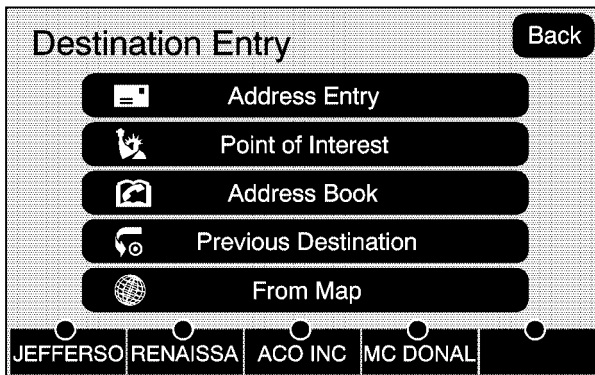

To use the preset destination entry method:

1. Press the DEST hard key.
2. Select the desired preset destination screen button. The screen buttons are labeled with the name that was selected for the destination when it was stored. The map screen displays with the destination marked.
3. Select the route preference (Fastest, Shortest, or Other). The system calculates and highlights the route.
4. Select the Start Guidance screen button. The route can now be started.

See “Getting Started on Your Route” later in this section for more information.

Getting Started on Your Route

Once a destination has been entered, there are several functions that can be performed. Press the DEST hard key to access the Route screen.

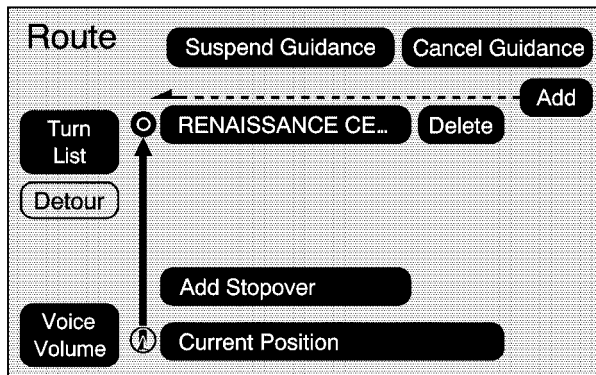

Turn List

Turn List: Select to view the list of turn maneuvers for the entire route and to avoid turns on the route.

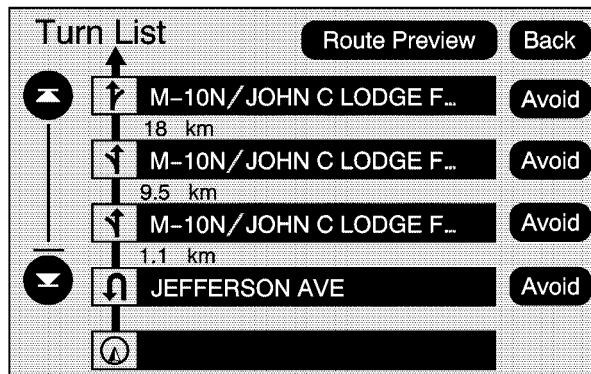

▲ / ▼ (Scroll Arrows): Select the up and down arrow to scroll through the list of maneuvers.

Avoid: Select this screen button, next to the adjacent street name, to avoid the maneuver.

The map screen displays. The route will re-calculate without that maneuver.

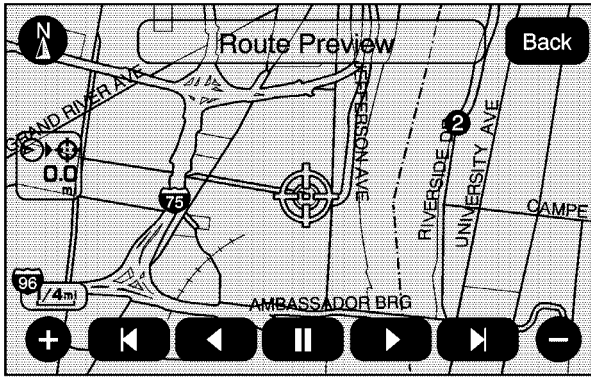

Route Preview: Select to preview the entire route in either direction.

◀ (Reverse Skip): Select to go back to the start point or previous stopover.

◀ / ◀◀ (Reverse Scroll): Select to scroll to the start point or previous stopover. The ◀ button changes to a fast reverse screen button.

⏸ (Pause): Select to pause the route preview, while in reverse or fast forward scroll.

▶ / ▶▶ (Fast Forward Scroll): Select to scroll to the next stopover or to the final destination. The ▶ button changes to a fast speed fast forward.

▶ (Fast Forward Skip): Select to go to the next stopover or to the final destination.

Detour

Detour: Select this button from the Route screen, then select to detour 1 mile, 3 miles, or 5 miles (1 km, 3 km, 5 km) around the current route. You may also select to detour the whole route if necessary. This option is only available while you are driving on your current planned route.

Voice Volume

Select this button from the Route screen to turn voice guidance on or off and to change the volume of voice prompts. See “Nav” under *Configure Menu* on page 2-29 for more information.

Add Stopover

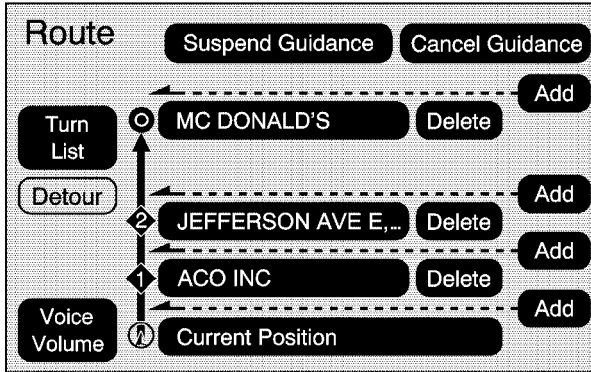

Add Stopover: Select this button from the Route screen. This feature lets you add up to three stopovers to the current route, between your start point and final destination. Once a stopover has been added, the points can be edited or deleted.

To add a stopover:

1. Press the DEST hard key.
2. Select the Add or Add Stopover screen button. This button only appears if a route has been calculated.
3. Using the desired method of entering a destination, enter the stopover. See "Destination" previously for more information.
4. Select the route preference (Fastest, Shortest, or Other). The system calculates and highlights the route.
5. Select the Start Guidance screen button. The route can now be started.
6. To add the second and third stopovers, press the DEST hard key, then select the Add screen button, where the next stopover should display on the route.
7. Select the route preference (Fastest, Shortest, or Other). The system calculates and highlights the route.
8. Select the Start Guidance screen button. The route can now be started.

To delete a stopover from the current route:

1. Press the DEST hard key.
2. Select the Delete screen button for a stopover to be deleted.
3. The system displays a pop-up confirmation message. Select OK to delete the stopover; select Cancel to cancel this operation.
4. Select the route preference (Fastest, Shortest, or Other). The system calculates and highlights the route.
5. Select the Start Guidance screen button. The route can now be started.

Suspend Guidance

Select this button from the Route screen to put the current route on hold.

Resume Guidance

Select this button from the Route screen to resume guidance on the current route.

Cancel Guidance

Select this button from the Route screen to cancel the current route.

Adding Destinations to the Address Book

There are two ways to add a destination to the address book:

- To add the current final destination to the address book, select the Mark screen button from the map screen. The system automatically saves the final destination information in the address book.
- Select the Add to Address Book screen button when available on POI information screens, Destination Entry screens, or POI screens. The system automatically saves this information in the address book.

See “Nav” under *Configure Menu on page 2-29* for information on editing address book entries.

Adding or Changing Preset Destinations

This feature lets you add or change one of five preset destinations. When a destination has been added as a preset destination, it is available to be selected from the Destination Entry screen. See “Preset Destination” previously for information on how to select a preset destination as a final destination.

To store the current final destination as a preset destination:

1. Select the Mark screen button from the map screen to add the current final destination. The Address Book screen appears.
2. Select the Name screen button. An alpha-keyboard displays. Enter the name.
3. Press and hold one of the buttons at the bottom of the screen until the name appears in that preset destination screen button. It is now available to select from the Destination Entry screen.

To store an address book entry as a preset destination:

1. Press the MENU hard key, then press the MENU key repeatedly until Nav is selected, or select the Nav screen button.
2. Select the Edit/View screen button.
3. Select the address book entry to be stored as the preset destination. Select the Name screen button to add a name, if needed.
4. Press and hold one of the buttons at the bottom of the screen until the name appears in that preset destination screen button. It is now available to select from the Destination Entry screen.

Configure Menu

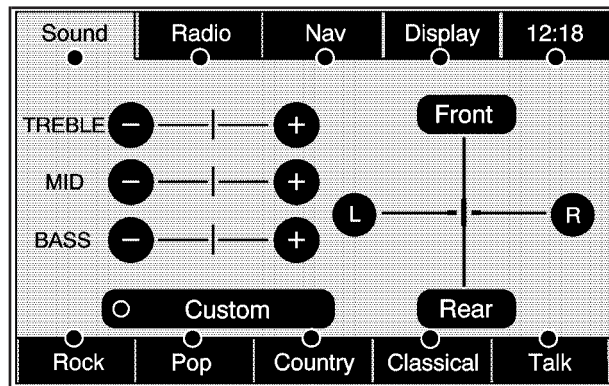

Base shown; Uplevel similar

Press the MENU hard key to adjust several of the system's features and preferences. The last selected menu screen is the screen that displays; Sound, Radio, Nav (navigation), Display, or Time.

Sound

Press the MENU key to enter the menu options, then press the MENU key repeatedly until Sound is selected or select the Sound screen button. To make speaker and equalization adjustments. See *Navigation Audio System on page 3-2* for more information.

Radio

Press the MENU key to enter the menu options, then press the MENU key repeatedly until Radio is selected or select the Radio screen button, to make changes for radio information displayed, preset pages, XM™ categories, and automatic volume control. See *Navigation Audio System on page 3-2* for more information.

Nav (Navigation)

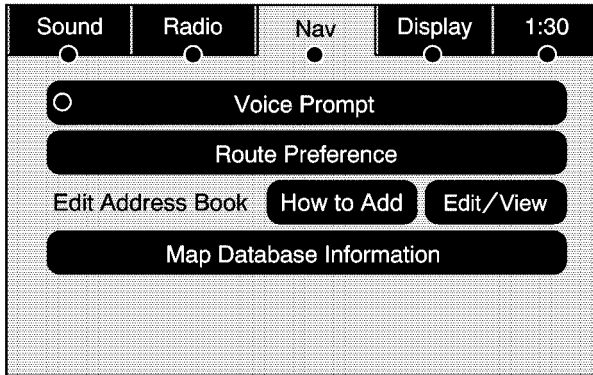

Press the MENU key to enter the menu options, then press the MENU key repeatedly until Nav is selected or select the Nav screen button.

Voice Prompt

Voice Prompt: Select to change the volume of the voice prompts or to turn voice guidance on and off.

Volume: Select the + (plus) or – (minus) to increase or to decrease the volume of the voice prompts. The system respond with the adjusted voice level.

Voice Guidance: Select On or Off to turn voice instructions on and off while traveling on a planned route.

Route Preference

Select this button to change route options when the system calculates a route.

Allow Major Roads: Major roads are used when calculating a planned route.

Allow toll road: Toll roads are used when calculating a planned route.

Allow ferry: Ferries are used when calculating a planned route.

Allow time and seasonal restricted road: Time restricted and seasonal roads are used when calculating a planned route.

Edit Address Book — How to Add

To add an address to the address book, see “Adding Destinations to the Address Book” under *Destination on page 2-14*.

Edit Address Book — Edit/View

To edit the name of an address book:

1. Press the MENU key, then press the MENU key repeatedly until Nav is selected or select the Nav screen button.
2. Select the Edit/View Address Book screen button.
3. Select the Address book entry.

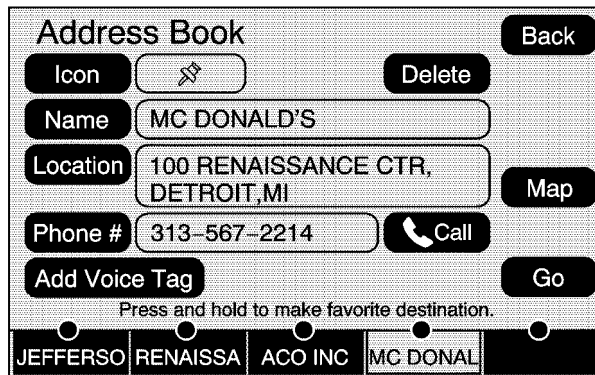

4. Select the Name screen button and use the alpha keyboard to edit or add the name.
5. Select the OK screen button to save changes.

To add or change the phone number of an address book entry:

1. Press the MENU key, then press the MENU key repeatedly until Nav is selected, or select the Nav screen button.
2. Select the Edit/View Address Book screen button.
3. Select the address book entry to change.
4. Select the Phone # screen button and use the numeric keyboard to enter or change the phone number.
5. Select the OK screen button to save the changes.

To change the map icon of an address book entry:

1. Press the MENU key then press the MENU key repeatedly until Nav is selected, or select the Nav screen button.
2. Select the Edit/View Address Book screen button.
3. Select the address book entry to change.
4. Select the Icon screen button.
5. Select an icon from the list.

To add a voice tag to an address book entry:

1. Press the MENU key, then press the MENU key repeatedly until Nav is selected, or select the Nav screen button.
2. Select the Edit/View Address Book screen button.
3. Select the Add Voice Tag screen button.
4. The system asks you to state the name. You have four seconds to do this. The system repeats the name.

To delete an address book entry:

1. Press the MENU key, then press the MENU key repeatedly until Nav is selected, or select the Nav screen button.
2. Select the Edit/View Address Book screen button.
3. Select the address book entry to delete.
4. Select the Delete screen button to delete the address book entry.
5. A confirmation pop-up displays. Select OK to delete; select No to cancel the operation.

To delete the entire address book:

1. Press the MENU key, then press the MENU key repeatedly until Nav is selected, or select the Nav screen button.
2. Select the Edit/View Address Book screen button.
3. A list of all the address book entries display. Press and hold the Clear All screen button.
4. A confirmation pop-up displays. Select OK to delete; select No to cancel the operation.

Map Database Information

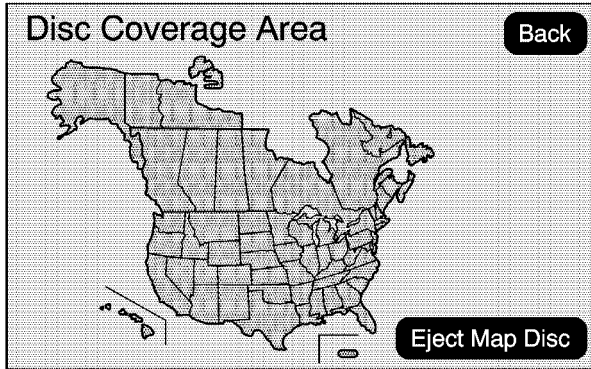

Select the Map Database Information screen button to view the coverage areas of the map DVD.

Eject Map Disc: When the DVD map disc is not loaded, the navigation portion of the system cannot be used.

1. Press the MENU key to enter the Menu options, then press the MENU key repeatedly until Nav is selected, or touch the Nav screen button.
2. Touch the Map Database Information screen button.
3. Touch the Eject Map Disc screen button. The screen tilts, exposing the map DVD slot.
4. Press eject, located next to the DVD map disc slot, and the disc ejects. Pull the disc out. The screen cannot be closed until a double beep is heard.

Notice: Pressing directly on the navigation screen may cause damage. Repairs would not be covered by your warranty. Do not press directly on the navigation screen.

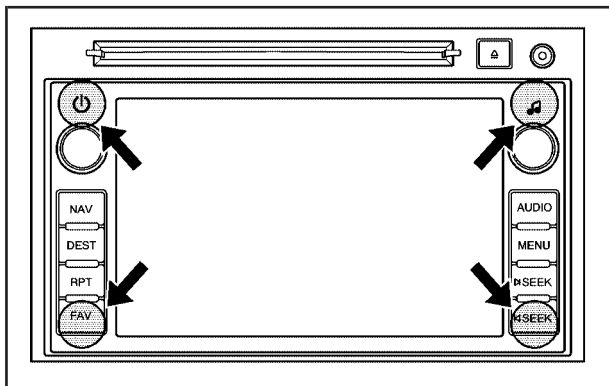

- To close the screen, slightly push up on the two outer corners until the screen is in position. Then push the screen in by pushing on the four outer corners until you hear a click.

Display

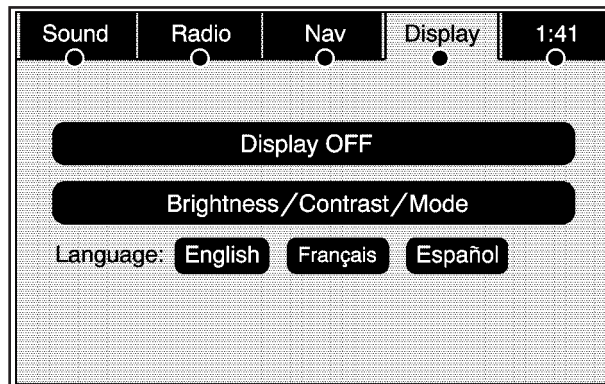

VUE shown

Press the MENU key to enter the menu options, then press the MENU key repeatedly until Display is selected, or select the Display screen button.

Display Off

Select this button to turn the display off. Press the Nav, Dest, Fav, or Menu hard key or the 🎵 (tone) button to view the display.

Brightness/Contrast/Mode

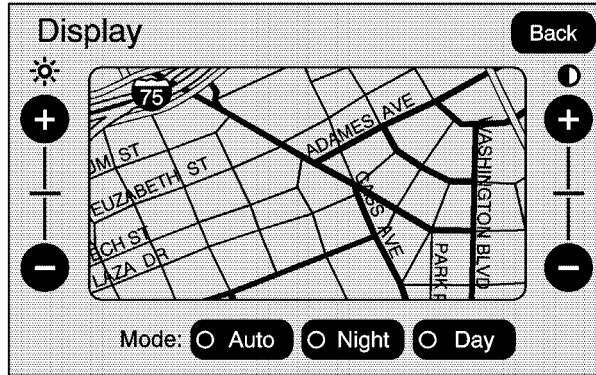

Select this screen button to change the brightness, contrast, and mode of the display.

 **(Brightness):** Select and hold the + (plus) or – (minus) to increase or decrease the brightness of the screen.

 **(Contrast):** Select and hold the + (plus) or – (minus) to increase or decrease the contrast of the screen.

Auto (Automatic): Select for the system to automatically adjust the screen background depending on exterior lighting conditions.

Night: Select to make the map background darker.

Day: Select to make the map background brighter.

Language

Saturn VUE Only — Select the English, Francais or Espanol screen buttons to change the language of the navigation screens.

If your vehicle has a DIC, see “DIC Vehicle Customization” in the Index of your vehicle’s owner manual to change the language of the navigation screens.

Setting the Clock

Press the MENU key to enter the menu options, then press the MENU key repeatedly until the time is selected, or select the time screen button, then press the Set screen button.

Hours: Select and hold the – (minus) or + (plus) to decrease or increase the hours.

Minutes: Select and hold the – (minus) or + (plus) to decrease or increase the minutes.

12/24 Format: Select the 12 screen button for standard time; select the 24 screen button for military time.

Rear Vision Camera

Your vehicle may have a rear vision camera system. Read this entire section before using the camera system.

The rear vision camera system is designed to help the driver when backing up by displaying a view, on the navigation screen, of the area behind the vehicle when the driver shifts the vehicle into REVERSE (R). Once the driver shifts out of REVERSE (R), the navigation screen will go back to the last screen that had been displayed, after a delay.

Turning the Rear Vision Camera System On or Off

To turn the rear vision camera system on or off, do the following:

1. Shift into PARK (P).
2. Press the MENU hard key to enter the configure menu options, then press the MENU hard key to select Display or touch the Display screen button.
3. Select the Rear Camera Options screen button. The Rear Camera Options screen will display.

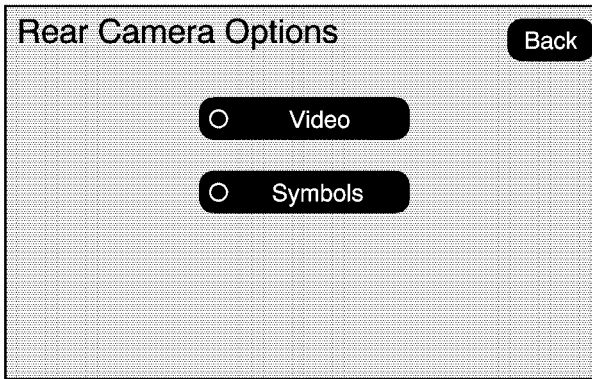

4. Select the Video screen button. When the Video screen button is highlighted the RVC system is on.

The delay that is received after shifting out of REVERSE (R) is approximately 10 seconds. The delay can be cancelled by performing one of the following:

- Pressing a hard key on the navigation system.
- Shifting in to PARK (P).
- Reach a vehicle speed of 5 mph (8 km/h).

There is a message on the rear vision camera screen that states “Check Surroundings for Safety”.

⚠ CAUTION:

The Rear Vision Camera (RVC) system does not replace driver vision. RVC does not:

- Detect objects that are outside the camera’s field of view, below the bumper, or underneath the vehicle.
- Detect children, pedestrians, bicyclists, or pets.

Do not back the vehicle by only looking at the rear vision camera screen, or use the screen during longer, higher speed backing maneuvers or where there could be cross-traffic. Your judged distances using the screen will differ from actual distances.

So if you do not use proper care before backing up, you could hit a vehicle, child, pedestrian, bicyclist, or pet, resulting in vehicle damage, injury, or death. Even though the vehicle has the RVC system, always check carefully before backing up by checking behind and around your vehicle.

Rear Vision Camera Location

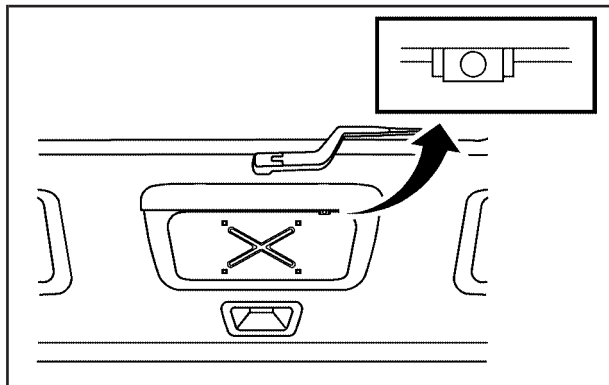

Acadia shown, Enclave and OUTLOOK similar

The image is provided by the camera located above the license plate.

The camera uses a special lens. The distance of the image that appears on the screen differs from the actual distance. The area displayed by the camera is limited. The camera does not display objects which are close to either corner of the bumper or under the bumper. The area displayed on the screen may vary according to vehicle orientation or road conditions.

The following illustration shows the field of view that the camera provides.

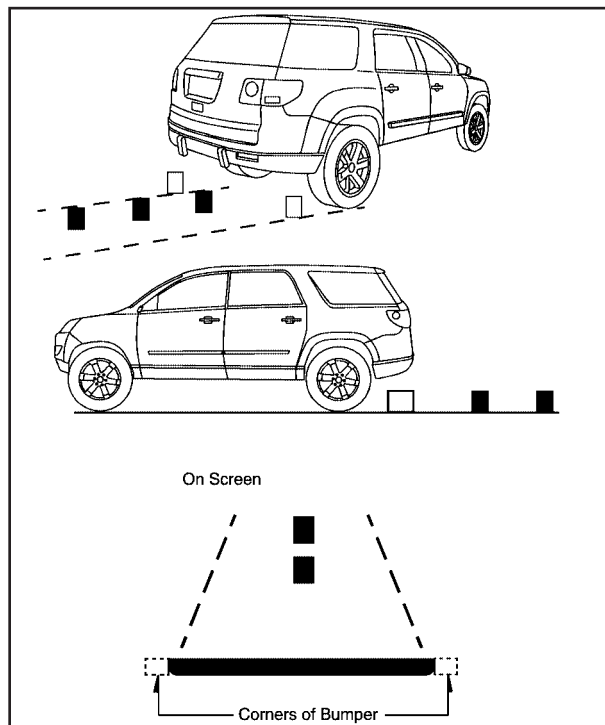

OUTLOOK shown; Acadia and Enclave similar

Adjusting the Brightness and Contrast of the Screen

To adjust the brightness and contrast of the screen, press the MENU key while the rear vision camera image is on the display. Any adjustments made will only affect the rear vision camera screen.

 **(Brightness):** Touch the + (plus) or – (minus) screen buttons to increase or decrease the brightness of the screen.

 **(Contrast):** Touch the + (plus) or – (minus) screen buttons to increase or decrease the contrast of the screen.

Symbols

The navigation system may have a feature that lets the driver view symbols on the navigation screen while using the rear vision camera. The Ultrasonic Rear Park Assist (URPA) system must not be disabled to use the caution symbols. If URPA has been disabled and the symbols have been turned on, the Rear Parking Assist Symbols Unavailable error message may display. See “Ultrasonic Rear Park Assist (URPA)” in the Index of the vehicle’s owner manual.

The symbols appear when an object has been detected by the URPA system. The symbol may cover the object when viewing the navigation screen.

To turn the symbols on or off, do the following:

1. Make sure that URPA has not been disabled.
2. Shift into PARK (P).
3. Press the MENU hard key to enter the configure menu options, then press the MENU hard key repeatedly until Display is selected or touch the Display screen button.
4. Select the Rear Camera Options screen button. The Rear Camera Options screen will display.
5. Touch the Symbols screen button. The screen button will be highlighted when on.

When the System Does Not Seem To Work Properly

The rear vision camera system may not work properly or display a clear image in the following situations:

- RVC may be turned off. See “Turning the Rear Camera System On or Off” earlier in this section.
- In the dark.
- When the sun or the beam of headlights is shining directly into the camera lens.
- If ice, snow, mud, or anything else builds up on the camera lens. Clean the lens, rinse it with water, and wipe it with a soft cloth.
- If the back of the vehicle is in an accident, the position and mounting angle of the camera may change or the camera may be affected. Be sure to have the camera and its position and mounting angle checked at your dealer/retailer.
- Extreme high or low temperatures or extreme temperature changes can affect the image displayed.

Rear Vision Camera Error Messages

Service Rear Vision Camera System: This message may display when the system is not receiving information it requires from other vehicle systems.

If any other problem occurs or if a problem persists, see your dealer/retailer.

Global Positioning System (GPS)

The navigation system determines the position of your vehicle by using satellite signals, various vehicle signals, and map data.

At times, other interferences such as the satellite condition, road configuration, the condition of the vehicle and/or other circumstances can interfere with the navigation system’s ability to determine the accurate position of the vehicle.

The GPS shows the current position of your vehicle using signals sent by the GPS Satellites of the United States Department of Defense. When your vehicle is not receiving signals from the satellites, a symbol appears on the map screen. Refer to *Symbols on page 2-7*.

This system may not be available or interferences may occur if any of the following are true:

- Signals are obstructed by tall buildings, trees, large trucks, or a tunnel.
- Objects are located on the rear shelf of the vehicle.
- Satellites are being repaired or improved.
- After-market glass tinting has been applied to the vehicle's rear windshield.

Notice: Do not apply after-market glass tinting to the vehicle's windows. Glass tinting will interfere with the system's ability to receive GPS signals and cause the system to malfunction. You might have to replace the window to correct the problem. This would not be covered by your warranty.

For more information if the GPS is not functioning properly, see *If the System Needs Service on page 2-43* and *Problems with Route Guidance on page 2-42*.

Vehicle Positioning

At times, the position of the vehicle on the map may be inaccurate due to one or more of the following reasons:

- The road system has changed.
- The vehicle is driving on slippery road surfaces such as in sand, gravel, and/or snow.
- The vehicle is traveling on winding roads.
- The vehicle is on a long straight road.
- The vehicle is approaching a tall building or a large vehicle.
- The surface streets run parallel to a freeway.
- The vehicle has just been transferred by a vehicle carrier or a ferry.
- The current position calibration is set incorrectly.
- The vehicle is traveling at high speed.
- The vehicle changes directions more than once, or when the vehicle is turning on a turn table in a parking lot.
- The vehicle is entering and/or exiting a parking lot, garage, or a lot with a roof.

- The GPS signal is not received.
- A roof carrier is installed on your vehicle.
- The vehicle is being driven with tire chains.
- The tires are replaced.
- The tire pressure for your tires is incorrect.
- The tires are worn.
- The first time the map DVD is inserted.
- The battery is disconnected for several days.
- The vehicle is driving in heavy traffic where driving is at low speeds, and the vehicle is stopped and started repeatedly.

If you experience problems with your system, see your dealer/retailer.

Problems with Route Guidance

Inappropriate route guidance could occur under one or more of the following conditions:

- You have not turned onto the road indicated.
- Route guidance may not be available when using automatic rerouting for the next right or left turn.

- The route may not be changed when using automatic rerouting.
- There is no route guidance when turning at an intersection.
- Plural names of places may be announced occasionally.
- It may take a long time to operate automatic rerouting during high-speed driving.
- Automatic rerouting may display a route returning to the set stopover if traveling to a destination without passing through a set stopover.
- The route prohibits the entry of a vehicle due to a regulation by time or season or any other regulation which may be given.
- Some routes may not be searched.
- The route to the destination may not be shown if there are new roads, if roads have recently changed, or if certain roads are not listed on the map DVD. See *Ordering Map DVDs on page 2-43*.

If the System Needs Service

If your system needs service and you have followed the steps listed here and still are experiencing problems, see your dealer/retailer for assistance.

Ordering Map DVDs

The map DVD in your vehicle is the most up-to-date information available when your vehicle was produced. The map DVD is updated periodically, provided that the map information has changed.

If you have any questions about the operation of the navigation system or the update process, contact the GM Nav Disc Center toll-free phone number, 1-877-NAV-DISC (1-877-628-3472) or go to the center's website, www.gmnavdisc.com. If you need any updates or a replacement disc, because the current disc is lost, damaged, or needs to be updated, call the GM Nav Disc Center or order a new disc online.

To order a disc, have your Vehicle Identification Number (VIN) available. This helps the center make sure you receive the correct and most up-to-date DVD map disc for your vehicle. See "Vehicle Identification Number (VIN)" in the Index of your vehicle's owner manual for more information.

After receiving the updated disc, replace the old disc in the navigation system. See "Installing the DVD Map Disc" and "Ejecting the DVD Map Disc" under *Maps on page 2-4*. Dispose of the old disc to avoid confusion about which disc is the most current.

Database Coverage Explanations

Map detail varies. Some areas have greater map detail than others. The navigation system will only work as well as the information provided by the map disc. See *Ordering Map DVDs on page 2-43*.

Section 3 Navigation Audio System

Navigation Audio System	3-2	DVD Player	3-17
CD Player	3-10	Auxiliary Devices	3-24

Navigation Audio System

Notice: Before adding any sound equipment to your vehicle, such as an audio system, CD player, CB radio, mobile telephone, or two-way radio, make sure that it can be added by checking with your dealer/retailer. Also, check federal rules covering mobile radio and telephone units. If sound equipment can be added, it is very important to do it properly. Added sound equipment can interfere with the operation of your vehicle's engine, radio, or other systems, and even damage them. Your vehicle's systems can interfere with the operation of sound equipment that has been added.

Notice: The chime signals related to seat belts, parking brake, and other functions of your vehicle operate through the navigation system. If that equipment is replaced or additional equipment is added to your vehicle, the chimes may not work. Make sure that replacement or additional equipment is compatible with your vehicle before installing it. See "Accessories and Modifications" in the Index of your vehicle's owner manual.

Playing the Radio

(Power/Volume):

- Press to turn the audio system on and off.
- Turn to increase or to decrease the volume.
- Press and hold for more than two seconds to turn off the navigation system, the Rear Seat Entertainment (RSE) video screen, and Rear Seat Audio (RSA). If the vehicle has not been turned off, the RSE and the RSA can be turned back on by pressing this knob. The last active source resumes playing.

(Tuning Knob):

- Turn to go to the next or previous frequency.
- Press to go to the Sound menu.

AUDIO:

- Press to display the audio screen.
- Press to switch between AM, FM, or XM (if equipped), DISC, or AUX (Auxiliary), or select the screen button. See *CD Player on page 3-10*, *DVD Player on page 3-17*, or *Auxiliary Devices on page 3-24* for more information.

Finding a Station

There are three ways to find/change stations:

- If viewing a full map screen, use the \triangleright \triangleleft SEEK keys and 🎵 knob. You cannot change preset stations from the full map screen.

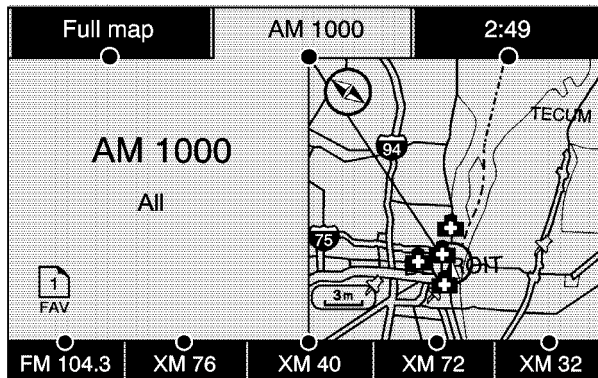

AM source shown, other sources similar

- If viewing a full map screen, select the source screen (AM, FM, XM, CD, etc.) button. The display splits between the audio screen and the map screen. All station-changing functions can be performed from this screen.

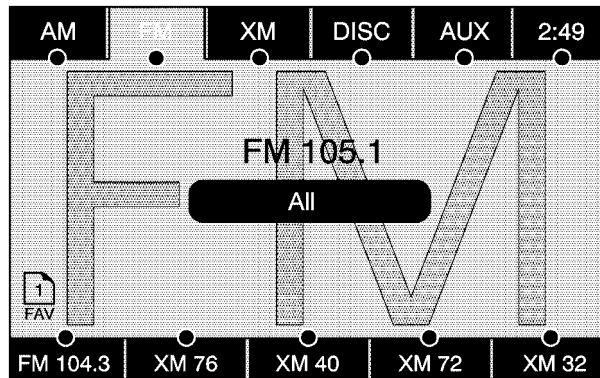

FM source shown, other sources similar

- If you do not want to view a split screen or you are not on a map screen, press the AUDIO hard key to enter the audio menu.

AM/FM/XM: Select the source (AM, FM, or XM, if equipped) screen button or press the AUDIO key repeatedly until the desired source is selected.

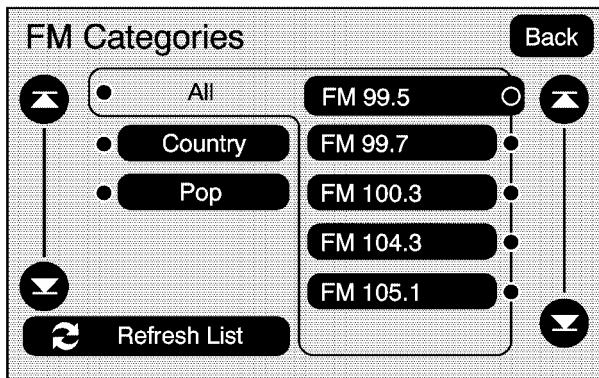

FM source shown, other sources similar

Category:

1. Select the screen button, located in the middle of the screen, to receive a list of all of the selected band stations in the area.
2. Use the up and down arrow screen buttons to scroll the frequencies.
3. Select the desired frequency.

XM lists also contain a category to select and the stations or channels that pertain to the category. For XM, select the left and right arrow screen buttons to change categories. The station information displays. See “Radio Menu” later in this section to add and remove XM categories from the category list. When listening to XM stations, you can select all of the categories when using the right and left arrow screen buttons on the main audio screen. Categories cannot be selected from the category list screen when they have been removed.

FM lists may also contain a category to select if stations in your area support Radio Data Systems (RDS).

Refresh List: Select this screen button to refresh the list of stations.

When viewing a map screen the name of the station or channel displays.

SEEK / SEEK: To seek stations, press the right or left arrow keys to go to the next or previous station.

To scan stations, press and hold either arrow for more than two seconds. The radio goes to a station, plays for a few seconds, then goes on to the next station. To stop scanning, press either arrow again.

Storing Radio Station Presets

This feature lets you store up to 30 preset stations. You can mix AM, FM, and XM (if equipped). To store presets:

1. Press  to turn the system on.
2. If viewing a map screen, select the source screen button, press the AUDIO key, or press the FAV (favorite) key.
3. Select the band.
4. Seek, scan, or tune to the desired station, to select the station.
5. Press and hold one of the preset screen buttons for more than two seconds or until a beep is heard.
6. Repeat the steps for each preset.

Sound Menu

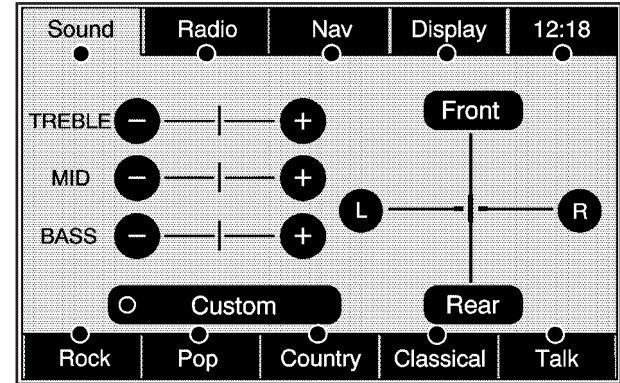

Base shown; Uplevel similar

SOUND: Press this key or press the MENU key to access the Sound menu to adjust the treble, midrange, bass, fade, balance, and equalization.

Setting the Tone

TREBLE: Select and hold the plus (+) or minus (-) sign to increase or decrease the treble. If a station is weak or noisy, decrease the treble.

MID (Midrange): Select and hold the plus (+) or minus (-) sign to increase or decrease the midrange.

BASS: Select and hold the plus (+) or minus (-) sign to increase or decrease the bass.

Adjusting the Speakers

L/R (Left/Right) (Balance): To adjust the balance between the left and the right speakers, select and hold the L or R screen buttons.

Front/Rear (Fade): To adjust the fade between the front and the rear speakers, select and hold the Front or Rear screen buttons.

Automatic Equalization

With automatic equalization you can select customized equalization settings designed for Rock, Pop, Country, Classical, and Talk. Select one of the equalization screen buttons to hear the change in sound.

Custom: Select this screen button to adjust the bass, treble, and midrange settings as desired.

The system saves separate settings for each source.

Talk: The Acadia and Enclave will only have an equalization setting for Talk.

Select Talk to adjust the tone settings to an automatic preset for talk radio.

Rear Seat Audio (RSA)

With this feature, if the Rear Seat Audio (RSA) system has been turned on, it can be turned off by selecting the Rear Seat Audio Off screen button. See "Rear Seat Audio (RSA)" in the Index of your vehicles owner manual.

Radio Menu

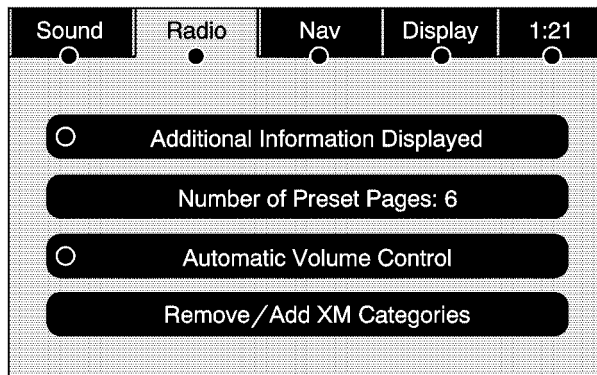

Press the MENU key to enter the configure menu screen, then press it repeatedly until Radio is selected, or select the Radio screen button to make changes for radio information displayed, number of preset pages, XM categories, if equipped, and automatic volume control.

Additional Information Displayed

Select the Additional Information Displayed screen button to turn station, channel, CD, and MP3 information on or off. The information displays when the screen button is highlighted.

When the screen button is highlighted the system displays, when it is available, for the following; FM: RDS category name and radio text, XM: Song Title and Artist Name, CD: CD text, MP3: tag information.

Number of Preset Pages

Select the Number of Preset Pages screen button to change the number of preset pages, 1 through 6. Each preset page can contain five preset stations. Select the desired numbered screen button.

Automatic Volume Control

Automatic Volume Control: With automatic volume control, your audio system adjusts automatically to make up for road and wind noise as you drive.

To use Automatic Volume Control:

1. Set the volume at the desired level.
2. Press the MENU key to enter the menu screen, then press it repeatedly until Radio is selected, or touch the Radio screen button.
3. Press the Automatic Volume Control screen button.
4. Touch the LOW, MEDIUM, or HIGH screen buttons. Each higher setting allows for more compensation at faster vehicle speeds.

Then, as you drive, automatic volume control automatically increases the volume, as necessary, to overcome noise at any speed. The volume level should always sound the same to you as you drive. To turn automatic volume control off, touch the OFF screen button.

Remove/Add XM Categories

1. Select the Remove/Add XM Categories screen button to remove or add XM categories when selecting from the category list screen. The list of XM categories appear on the screen.
2. Use the up and down arrow screen buttons to scroll through the list. The categories to remove will be highlighted and the categories to add will be dark in color.
3. Select the category that you would like to add or remove.
4. Select the Restore All Categories screen button to add all categories that have been removed.

Radio Data System (RDS)

The audio system has a Radio Data System (RDS). RDS features are available for use only on FM stations that broadcast RDS information. With RDS, the radio can:

- Seek to stations broadcasting the selected type of programming
- Receive announcements concerning local and national emergencies
- Display messages from radio stations

This system relies on receiving specific information from these stations and only work when the information is available. In rare cases, a radio station may broadcast incorrect information that can cause the radio features to work improperly. If this happens, contact the radio station.

The RDS system is always on. When information is broadcast from the FM station you are listening to, the station name or call letters display on the audio screen. RDS may provide a program type (PTY) for current programming and the name of the program being broadcast.

XM™ Satellite Radio Service

XM™ is a satellite radio service that is based in the 48 contiguous United States and 10 Canadian provinces. XM™ Satellite Radio has a wide variety of programming and commercial-free music, coast-to-coast, and in digital-quality sound. During your trial or when you subscribe, you will get unlimited access to XM™ Radio Online for when you are not in your vehicle. A service fee is required to receive the XM™ service. For more information, contact XM™ at www.xmradio.com or call 1-800-929-2100 in the U.S. and www.xmradio.ca or call 1-877-438-9677 in Canada.

When XM™ is active, the channel name and number, song title, and artist displays on the screen.

XM™ Radio Messages

XL (Explicit Language Channels): XL on the radio display, after the channel name, indicates content with explicit language. These channels, or any others, can be blocked at a customer's request by calling 1-800-852-XXMX (9696).

XM Updating: The encryption code in the receiver is being updated and no action is required.

No XM signal: The vehicle is in a location that is blocking the XM™ signal. When the vehicle is moved into an open area, the signal should return.

Loading XM: The audio system is processing audio and text data received. No action is needed.

Channel Off Air: This channel is not currently in service.

Channel Unavail: This previously assigned channel is no longer assigned.

No Artist Info: No artist information is available. The system is working properly.

No Title Info: No song title information is available. The system is working properly.

No CAT Info: No category information is available. The system is working properly.

Not Found: There are no channels available for the selected category. The system is working properly.

No Information: No text or informational messages are available. The system is working properly.

XM Theftlocked: The XM™ receiver may have previously been in another vehicle. For security purposes, XM™ receivers cannot be swapped between vehicles. If this message is received after having your vehicle serviced, check with your dealer/retailer.

XM Radio ID: If tuned to channel 0, this message alternates with the XM™ Radio eight digit radio ID label. This label is needed to activate the service.

Unknown: If this message is received when tuned to channel 0, there may be a receiver fault. Consult with your dealer/retailer.

Check XM Receiver: If this message does not clear within a short period of time, the receiver may have a fault. Consult with your dealer/retailer.

CD Player

The player can be used for CDs with conventional CD audio, MP3, or WMA compressed files and may have the capability to play DVD audio and DVD video. See *DVD Player on page 3-17* for more information about DVD audio and video.

With the ignition on, insert a CD partway into the slot, label side up. The player pulls it in and the CD should begin playing. The navigation system can be used while playing a CD.

When you insert a CD, the CD tab displays. If you select an equalization setting for the CD, it is activated each time you play a CD.

If you turn off the ignition or radio with a CD in the player, it stays in the player. When you turn on the ignition or radio, the CD starts playing where it stopped, if it was the last selected audio source.

As each new track starts to play, the track number appears on the display.

If playing recorded media such as, CD-R(W) the sound quality may be reduced due to CD quality, the method of recording, the quality of the music that has been recorded, recording speed, max media recording speed, and the way the CD has been handled. There may be an increase in skipping, difficulty in finding tracks, and/or difficulty in loading and ejecting. If these problems occur, check the bottom surface of the CD. If the surface of the CD is damaged, such as cracked, broken, or scratched, the CD does not play properly. If the surface of the CD is soiled, see "Care of Your CDs" in the Index of your vehicle's owner manual.

If there is no apparent damage, try a known good CD.

Notice: If a label is added to a CD, or more than one CD is inserted into the slot at a time, or an attempt is made to play scratched or damaged CDs, the CD player could be damaged. While using the CD player, use only CDs in good condition without any label, load one CD at a time, and keep the CD player and the loading slot free of foreign materials, liquids, and debris.

Do not add any label to a CD, it could get caught in the CD player. If a CD is recorded on a personal computer and a description label is needed, try labeling the top of the recorded CD with a soft marker.

If an error displays, see "CD Messages" later in this section.

If viewing a map screen, select the CD screen button or the NAV hard key. The display splits between the audio screen and the map screen. If you do not want to view a split screen or you are not on a map screen, press the AUDIO key, then press it repeatedly until CD is selected or select the CD screen button.

Playing an Audio CD

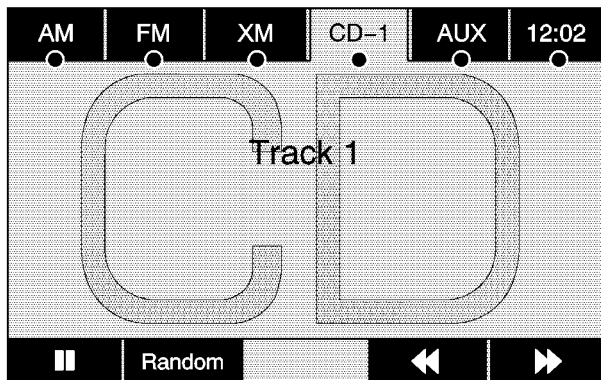

⏸▶ (Pause/Play):

1. Select to pause the CD. This button then changes to the play button.
2. Select the play button to play the CD.

Random:

1. Select to hear the tracks in random, rather than sequential, order.
2. Select Random again to turn off random play.

⏮(Rewind):

1. Select and hold to rewind quickly through a track selection. You will hear sound at a muted or a reduced volume.
2. Release this button to stop rewinding. The display shows the elapsed time of the track.

▶(Forward):

1. Select and hold to fast forward quickly through a track selection. You will hear sound at a muted or a reduced volume.
2. Release this button to stop fast forwarding. The display shows the elapsed time of the track.

⏭ SEEK / ⏪ SEEK:

1. To seek tracks, press the up arrow to go to the next track.
2. Press the down arrow to go to the start of the current track, if more than eight seconds have played.
3. If either arrow is pressed more than once, the player continues moving backward or forward through the CD. The sound mutes while seeking.

🎵 (Tuning Knob):

1. Turn counterclockwise one notch to go to the start of the current track, turn it again to go to the previous track.
2. Turn clockwise to go to the next track.

While playing an audio CD the rear seat operator can power on the RSE video screen and use the remote control to navigate through the tracks on the CD.

Using a Compressed Audio CD/DVD Compressed Audio CD/DVD Format

There are guidelines that must be met, when creating an MP3, WMA, or mixed disc. If the guidelines are not met when recording a burned disc, the disc may not play. The guidelines are:

- ID3 tag information is displayed by the radio if it is available. The radio supports ID3 tag information v1.0, v1.1, and v2.0. The radio displays a filename, song name, artist name, album name, and directory name.
- Maximum 32 characters, including spaces, in a file or folder name.
- The recommended maximum number of folders is 100 with a maximum hierarchy of three folders.
- Create a folder structure that makes it easy to find songs while driving. Organize songs by albums using one folder for each album.

- All playlist files (.m3u or .pls) must be removed from disc contents. Playlists are not supported.
- It is recommended that there is a maximum of 192 files on a CD-R(W) disc.
- It is recommended that there is a maximum of 200 files on a DVD+R(W) disc.
- The files can be recorded on a CD-R(W) or DVD+R(W).
- Copy protected WMA files are not supported.

Scanning Compressed Audio Disc

Scanning a compressed audio disc categorizes and allows sorting of songs by folder artist or album.

- Select center folder/artist/album button to initiate scanning mode. The radio plays and a progress bar displays.
- Background scanning occurs with the radio on and the compressed audio disc inserted but not being played.
- Only the first 200 songs appears in the compressed audio music navigator.
- Scanning time varies depending on the number of files and folders on the disc.

Root Directory

The root directory is treated as a folder. If the root directory has compressed audio files, the directory is displayed as ROOT. All files contained directly under the root directory is accessed prior to any root directory folders.

Empty Directory or Folder

If a root directory or a folder exists somewhere in the file structure that contains only folders/subfolders and no compressed files directly beneath them, the player advances to the next folder in the file structure that contains compressed audio files and the empty folder is displayed or numbered.

No Folder

When the disc contains only compressed files, the files are located under the root folder. The next and previous folder functions have no function on a disc that was recorded without folders. When displaying the name of the folder the radio displays ROOT.

Order of Play

Tracks are played in the following order:

- The radio does not support playlist files.
- Order of play differs depending if the compressed audio disc is fully scanned or unscanned. See “Scanning Compressed Audio Disc” previously in this section.
- When playing an unscanned disc, the next and previous screen buttons may be required to switch away from the current folder when quickly seeking rather than allowing the last song of a folder to play to completion.
- Play begins from the first track under the root directory. When all tracks from the root directory have been played, play continues from files according to their numerical listing. After playing the last track from the last folder, play begins again at the first track of the first folder or root directory.
- A scanned compressed audio disc in artist/album modes only play songs within the current category. The next and previous screen buttons change to different artists or albums.

When play enters a new folder, the display does not automatically show the new folder name. The new track name displays.

File System and Naming

The song name that displays is the name that is contained in the ID3 tag. If the song name is not present in the ID3 tag, then the radio displays the file name without the extension (such as .mp3) as the track name.

Track names longer than 32 characters or four pages are shortened. The display does not show parts of words on the last page of text and the extension of the filename does not display.

Playing a Compressed Audio Disc

As stated earlier in this section, the player can be used for CDs with conventional CD audio, MP3, or WMA compressed files. Read the information under “CD Player” for more information on playing an audio disc.

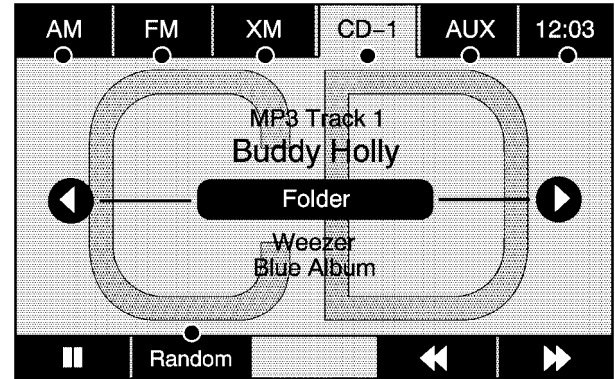

||▶ (Pause/Play):

1. Select to pause the CD. This button then changes to the play button.
2. Select the play button to play the CD.

Random:

1. Select to hear the tracks in random, rather than sequential, order.
2. Select Random again to turn off random play.

◀ (Rewind):

1. Select and hold to rewind quickly through a track selection. You will hear sound at a muted or reduced volume.
2. Release to stop rewinding. The display shows the elapsed time of the track.

▶ (Forward):

1. Select and hold to fast forward quickly through a track selection. You will hear sound at a muted or reduced volume.
2. Release to stop fast forwarding. The display shows the elapsed time of the track.

◀▶ (Folder/Artist/Album):

1. Select the left or right arrow to go to the previous or next folder, artist, or album on the disc.
2. Select the middle screen button, with the folder, artist, or album name, to sort the compressed audio file by folder, artist, or album. It may take a few minutes for the system to sort the compressed audio files. See "Scanning Compressed Audio Disc" previously in this section.

▷ SEEK / ◀ SEEK:

1. Press the up arrow to go to the next track.
2. Press the down arrow to go to the start of the current track, if more than eight seconds have played.
3. If either arrow is pressed more than once, the player continues moving backward or forward through the CD. The sound mutes while seeking.

🎵 (Tuning Knob):

1. Turn counterclockwise one notch to go to the start of the current track, turn it again to go to the previous track.
2. Turn clockwise to go to the next track.

Vehicles with Rear Seat Audio (RSA) can use RSA to change tracks/chapters. Vehicles with RSE can use the remote control to change tracks/chapters.

CD Messages

If Disc Read Error displays and/or the CD comes out, it could be for one of the following reasons:

- A disc was inserted with an invalid or unknown format.
- The map DVD disc was installed into the CD slot. See “Installing the Map DVD” under *Maps on page 2-4*.
- It is very hot. When the temperature returns to normal, the CD should play.
- You are driving on a very rough road. When the road becomes smoother, the CD should play.
- The CD is dirty, scratched, wet, or upside down.
- The air is very humid. If so, wait about an hour and try again.
- There may have been a problem while burning the CD.
- The label may be caught in the CD player.

If any error occurs repeatedly or if an error cannot be corrected, contact your dealer/retailer.

DVD Player

The player can be used for CD, MP3, DVD audio, and as a DVD video player.

With this feature, movies/pictures do not appear on the navigation screen, unless the vehicle is in PARK (P). It operates on the Rear Seat Entertainment (RSE) screen while the vehicle is moving. The RSE video screen starts play of the DVD when a DVD is inserted into the navigation system. The DVD player can be controlled by the buttons on the navigation system, the Rear Seat Audio (RSA) system, and the remote control. The DVD player can also be used for the rear seat passengers with the radio off. The rear seat passengers can power on the video screen and use the remote control to navigate the disc. See “Rear Seat Entertainment System” in the Index of your vehicle’s owner manual for more information.

The DVD player is only compatible with DVDs of the appropriate region code that is printed on the jacket of most DVDs.

The DVD slot is compatible with most audio CDs, CD-R, CD-RW, DVD-Video, DVD-Audio, DVD+R/RW single layer media along with MP3 and WMA formats. DVD-R, DVD-RW, and DVD+R dual layer media is not supported.

If playing any compatible DVD+R(W) the sound quality may be reduced due to disc quality, the method of recording, the quality of the video that has been recorded, and the way the disc has been handled. There may be an increase in skipping, difficulty in finding chapters, and/or difficulty in loading and ejecting. If these problems occur, check the bottom surface of the DVD. If the surface of the DVD is damaged, such as cracked, broken, or scratched, the DVD does not play properly.

If there is no apparent damage, try a known good DVD.

Notice: If you add any label to a DVD, insert more than one DVD into the slot at a time, or attempt to play scratched or damaged DVDs, you could damage the DVD player. When using the DVD player, use only DVDs in good condition without any label, load one DVD at a time, and keep the DVD player and the loading slot free of foreign materials, liquids, and debris.

Do not add any label to a DVD, it could get caught in the DVD player. If a DVD is recorded on a personal computer and a description label is needed, try labeling the top of the recorded DVD with a soft marker instead.

If an error displays, see “DVD Messages” later in this section.

Navigation DVD Radio with Bose® Surround Sound System (Acadia and Enclave Only)

If the vehicle has a Rear Seat Entertainment (RSE) system, it has a radio capable of playing both CD and DVD discs. See “Rear Seat Entertainment” in the Index of your vehicle’s owner manual.

The CD/DVD player is the top slot on the radio faceplate. The player is capable of reading the DTS programmed DVD-Audio or DVD-Video media. DTS and DTS 2.0 are trademarks of Digital Theater Systems, Inc. AC-3 is Dolby Digital Surround technology.

The system is optimized to use 5.1 audio surround sound before stereo tracks. Stereo modes are typically available if manually selected. Press the Options button, then the Audio button or DVD main or top menu.

Playing a DVD

There are three ways to play a DVD:

- Once a DVD is inserted, the system automatically starts play of the DVD up to the DVD top menu. The ►(play) button must be pressed to start the movie from the DVD’s menu screen.
- If you are on a map screen, select the DVD screen button.

- Press the AUDIO hard key, then select the DVD screen button.
- The ►(play) button must be pressed for the movie to resume play when the vehicle has been turned OFF and then back ON.

When a DVD is loaded, the rear seat passengers can power on the RSE video screen and use the remote control to navigate through the DVD.

⏻ (Power/Volume):

1. Press to turn the system on and off.
2. Turn to increase or decrease the volume of the audio system.
3. Press and hold for more than two seconds to turn off the navigation system, RSE video screen, and RSA. If the vehicle has not been tuned off, the RSE and the RSA can be turned back on by pressing this knob and continues play of the last active source.

DVD Menu Options

Once a DVD starts to play, the menu options and cursor screen buttons automatically appear. To display the menu Options screen button while a DVD is playing, touch anywhere on the screen.

Options: Select this screen button to view the menu option screen buttons. Menu options are available when they are highlighted. Some menu options are only available when the DVD is not playing.

Cursor: Select this screen button to access the cursor menu. The arrows and other cursor options let you navigate the DVD menu options. The cursor menu options are only available if a DVD has a menu. Use the cursor menu to start a DVD video from the disc main menu.

◀, ▲, ▶, ▼ (Arrow Buttons): Use these arrow buttons to move around the DVD menu.

Enter: Select to highlighted an option.

Return: Select to go back to the previous DVD menu.

Back: Select to go back to the main DVD display screen.

Move: Select to move the cursor buttons back and forth from the bottom-right corner to the top-left corner of the screen.

⏸▶ (Pause/Play):

1. Select to pause the DVD. This button then changes to the play button.
2. Select the play button to play the DVD.
3. Select this button in a DVD disc main menu to start the DVD.

■ (Stop):

1. Select to stop play of the DVD.
2. Select the play button to continue playing the DVD from where the DVD was stopped.
3. Select this button twice to return to the beginning of the DVD.

◀ (Rewind):

1. Select and release to rewind through the scene, chapters, and titles.
2. Select again to increase the rewinding speed.
3. Select the play button to stop rewinding. This button may not work when the DVD is playing the copyright information or the previews.

▶ (Forward):

1. Select and release to advance rapidly through the scene, chapters, and titles.
2. Select again to increase the fast forwarding speed.
3. Select the play button to stop fast forwarding. This button may not work when the DVD is playing the copyright information or the previews.

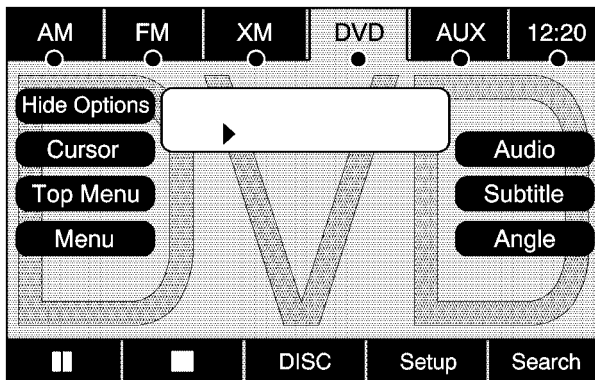

Hide Options: Select this screen button to remove all menu options from the display, except Options and Cursor.

Top Menu: Select to display the first menu of the DVD. This is not available on all DVDs.

Menu: Select to display the DVD menu of the current area of the DVD that is playing. This button is not available for DVD audio.

Audio:

1. Select to display the audio options.
2. Select the audio options that best improve sound quality. This is not available on all DVDs or when the DVD is stopped. This button may not be available for some DVD audio discs. Acadia only, see “Fading With a Bose® Surround Sound System” later in this section.

Subtitle: Select to play the video with subtitles. This is not available on all DVDs or when the DVD is stopped. This button is not available for DVD audio.

Angle:

1. Select to adjust the viewing angle of the DVD.
2. Repeatedly select this button to toggle through the angles. This is not available on all DVDs or when the DVD is stopped. This button is not available for DVD audio.

 **(Previous Scene):** Select to go to the previous scene. This button does not work when the DVD is stopped. This button is not available for DVD video.

 **(Next Scene):** Select to go to the next scene. This button does not work when the DVD is stopped. This button is not available for DVD video.

Search:

1. Select to display the search screen.
2. Select Title or Chapter Search for DVD video and Group or Track for DVD audio. The keyboard allows you to type in the title/chapter/group/track number that you would like to watch or listen to. This button does not work when the DVD is stopped.

Setup: Select to display the DVD Setup screen. This button is only available when the DVD is not playing. The DVD Setup screen allows you to change the brightness, contrast, and the viewing aspect on the monitor.

 **(Brightness):** Select the up or down screen arrows to increase or decrease the brightness of the navigation screen.

 **(Contrast):** Select the up or down screen arrows to increase or decrease the contrast of the navigation screen.

Monitor: From the DVD Setup screen, select to adjust the aspect ratio of the DVD on the navigation screen. This is not available on all DVDs. This button is not available for DVD audio.

Select  to close the screen in from the left and right sides.

Select  to fill the screen on the left and right sides.

Select  to fill the screen on the top and bottom.

SEEK  (Next Track/Chapter): Press this hard key to go to the next track or chapter. This button may not work when the DVD is playing the copyright information or the previews.

 SEEK (Previous Track/Chapter):

1. Press this hard key to return to the start of the current track or chapter.
2. Press again to go to the previous track or chapter. This button may not work when the DVD is playing the copyright information or the previews.

 (Tuning Knob):

1. Turn counterclockwise one notch to go to the start of the current chapter/track, turn it again to go to the previous chapter/track.
2. Turn clockwise to go to the next chapter/track.

Fading With a Bose® Surround Sound System (Acadia and Enclave Only)

When using fade in 5.1 Surround mode, the left front and right front speakers will fade rearward, leaving the center front speaker unaffected until the last fade step, then all front speakers mute.

If the Rear Seat Audio (RSA) is turned on, the radio disables fade and mutes the rear speakers.

When fading full rearward, you may want to select a stereo mode rather than surround. Stereo mode allows full audio content, center channel, voices, etc., to be faded rearward for rear occupants using vehicle speakers.

The following methods allow for switching surround sound into a 2 channel stereo mode:

- Select a stereo or 2 channel mode using the DVD-Video top menu. Most commercial DVD-Video top menus contain audio configuration settings.
- While the movie is playing, select **OPTIONS** to show all available DVD options. Select the **AUDIO** buttons to change current DVD audio track.

Some DVD-Video discs only contain Dolby Digital 5.1 (AC-3) or DTS 5.1 audio tracks and may not allow conversions into stereo modes.

See “Adjusting the Speakers” under *Navigation Audio System on page 3-2* Navigation Audio System for more information.

DVD Messages

If Disc Read Error appears on the display and/or the DVD comes out, it could be for one of the following reasons:

- A disc was inserted with an invalid or unknown format.
- The disc is not from a correct region.
- The map DVD disc was installed into the DVD audio/video slot. See “Installing the Map DVD” under *Maps on page 2-4*.

- It is very hot. When the temperature returns to normal, the DVD should play.
- You are driving on a very rough road. When the road becomes smoother, the DVD should play.
- The DVD is dirty, scratched, wet, or upside down.
- The air is very humid. If so, wait about an hour and try again.
- There may have been a problem while burning the DVD.
- The label may be caught in the DVD player.

If the DVD is not playing correctly, for any other reason, try a known good DVD.

If any error occurs repeatedly or if an error cannot be corrected, contact your dealer/retailer.

Auxiliary Devices

The vehicle may have a Rear Entertainment System (RSE). The RSE has audio adapters that lets you connect auxiliary devices. The audio can be heard through the speakers or through the wireless or wired headphones. See “Audio/Video Jacks” under “Rear Seat Entertainment System” in the Index of your vehicle’s owner manual for more information.

Drivers are encouraged to set up any auxiliary device while the vehicle is in PARK (P). See “Defensive Driving” in the Index of your vehicle’s owner manual for more information on driver distraction.

To switch the RSE system to use an auxiliary device:

1. Connect the auxiliary device to the RSE system.
2. Press the AUDIO key. Then press it repeatedly until AUX (auxiliary) is selected, or select the AUX screen button. A front auxiliary device must be connected before the front auxiliary device can be selected. The rear auxiliary device can be selected by pressing the REAR AUX button.

The rear auxiliary device system requires all video and audio inputs to be connected to ensure proper audio fidelity of the rear auxiliary device.

The rear seat passengers can also use the remote control to change the functions of the RSE. See “Rear Seat Entertainment System” in the Index of your vehicle’s owner manual for more information.

Section 4 Voice Recognition

Voice Recognition4-2

Voice Recognition

The navigation system's voice recognition allows for hands-free operation of the navigation system, audio system, and OnStar® features. The DVD map disc must be installed in the navigation system for voice recognition to work. See "Installing the DVD Map Disc" under *Maps on page 2-4*.

Voice recognition can be used when the ignition is on or when Retained Accessory Power (RAP) is active. See "Retained Accessory Power (RAP)" in the Index of your vehicle's owner manual for more information.

To use voice recognition, except for the VUE:

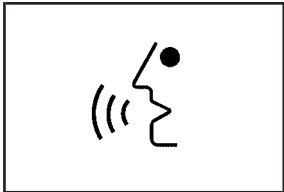

1. Push and hold the talk symbol steering wheel control until a beep is heard. The audio system mutes.

2. Clearly state one of the commands listed on the following pages.

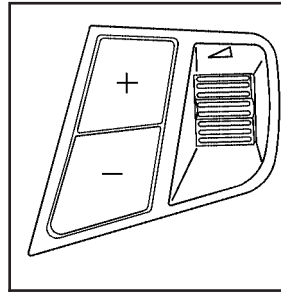

VUE

To use voice recognition, for the VUE:

1. Push and hold the center of the ◀(volume) thumbwheel, located on the steering wheel, until a beep is heard. The audio system mutes.
2. Clearly state one of the commands listed on the following pages.

Helpful Hints for Stating Commands

- When a multiple command is available, choose the command that works best for you.
- Words that are in brackets are optional. For example, for the command Radio [band] [select] FM, stating Radio FM or Radio select FM are both valid commands.
- When the system recognizes the command, the system does one of the following:
 - Perform the function.
 - Ask you to confirm your choice.
 - Issue an error message “Did not recognize. Voice Recognition Canceled.”
- If the system is not yet ready, the system displays a message.
- To cancel a command or if the system response does not match your verbal command, press and hold the talk symbol button. The system replies, “Voice Recognition Canceled”.
- If you experience difficulty with the system recognizing a command, try saying it more softly, and wait for a few seconds after the beep, or you may just try saying it again.

- Background noise may cause voice commands to be misunderstood, including airflow noise from wind.
- To use the voice recognition system, the map DVD must be loaded and the navigation system must be on.

This system is able to recognize commands in three different languages. The system only recognize commands based on the language selected from the Driver Information Center (DIC). See “Driver Information Center, DIC Vehicle Personalization” in the Index of your vehicles owner manual.

Voice Recognition Commands

The following list shows all of the voice commands available for the navigation system with a brief description of each. The commands are listed with the optional words in brackets. To use the voice commands, refer to the instructions listed previously.

The OnStar[®] voice command does not work unless Personal Calling is activated.

Voice Tag Commands

The following are voice tag commands that can be accessed by clearly stating the commands exactly as they are written. There can be up to 40 voice tag entries for destinations.

Navigation go to [destination], navigation select:

These commands instruct the system to select a destination saved under the stored voice tag.

The system prompts for a destination name then waits for the name to be stated.

If you are not currently driving on a route, the system automatically creates the voice tag destination as the final destination. If you are currently driving on a route, the system automatically creates the voice tag destination as a stopover. Up to three stopovers can be created.

Storing Voice Tags

From the address book entry information page, press the Add Voice tag screen button. The system responds “Name Please?” and you will have four seconds to record a name. The system asks for confirmation of the name before saving it as a voice tag.

Navigation Help

Navigation Help: This command instructs the system to assist with navigation commands.

Display Commands

To set the display mode:

Display [set] day [mode]: Sets the display to daytime mode.

Display [set] night [mode]: Sets the display to night mode.

Display [set] auto [mode]: Sets the display to automatic mode. The system changes between day and night mode automatically.

System help: This command instructs the system to assist with display commands.

Radio Commands

The following are radio commands can be accessed by clearly stating the commands exactly as written.

Radio [band] [select] AM, radio [band] [select] FM, radio [band] [select] XM, radio [band] [select] satellite:

Instructs the system to go to either the AM, FM, or XM™ (if equipped).

Radio [select] (frequency) AM, radio [select] (frequency) FM: Instructs the system to go to a specific frequency on either AM or FM.

Radio [select] (channel) XM, radio [select] (channel) satellite: Instructs the system to go to a specific channel on the XM™ band (if equipped).

Radio help: This command instructs the system to assist with radio commands.

CD Commands

The following are CD, MP3, and DVD commands that can be accessed by clearly stating the commands exactly as written.

CD, DVD, Disc: Selects a CD, DVD, or disc that is currently loaded.

CD, DVD, Disc, [select] track (one, two, three, etc.): Instructs the system to select a specific track number.

CD, DVD, Disc select next folder: Selects the next folder on the MP3 or audio DVD.

CD, DVD, Disc select previous folder: Selects the previous folder on the MP3 or audio DVD.

CD help, DVD help, Disc help: Instructs the system to assist with CD and DVD commands.

Auxiliary Commands

The following auxiliary commands can be accessed by clearly stating the commands exactly as written. The commands are available when the auxiliary source is available.

Aux, Auxiliary: Selects the auxiliary device, when a device is connected.

OnStar® Command

OnStar®: Instructs the system to connect to OnStar. The OnStar voice recognition system must be entered. Refer to your OnStar® owner guide for more information.

The OnStar® voice command does not work unless Personal Calling is activated.

Voice Help

Voice help: Provides a description of help commands that can be used.

A

Adding Destinations to the Address Book	2-27
Adding or Changing Preset Destinations	2-28
Alpha-Numeric Keyboard	2-3
Audio System	3-2
Auto Reroute	2-13
Auxiliary Devices	3-24

C

Canadian Owners	iv
Canceling Guidance	1-10
CD Messages	3-17
CD Player	3-10
Cleaning the Video Screen	1-11
Configure Menu	2-29

D

Database Coverage Explanations	2-43
Deleting Personal Information	1-7
Destination	2-14
Display	2-34
Driving on a Route	2-12
DVD Menu Options	3-19
DVD Messages	3-23
DVD Player	3-17

E

Ejecting the DVD Map Disc	2-5
English/Metric Units	1-6
Entering an Address and Point of Interest, and Storing Preset Destinations	1-7

F

Fading With a Bose® Surround Sound System (Acadia and Enclave Only)	3-22
Finding a Station	3-3

G

Getting Started, Navigation	1-4
Getting Started on Your Route	2-24
Global Positioning System (GPS)	2-40
Guidance Volume	1-11

H

Handling the DVD Map Disc	2-5
Hard Key Operation	2-2

I

Installing the DVD Map Disc	2-4
-----------------------------------	-----

L

Language	1-6
----------------	-----

M

Map Adjustments	2-6
Map Coverage	2-4
Map Scales	2-6
Maps	2-4
Menu	
Configure	2-29

N

Nav (Navigation)	2-30
Navigation	
Getting Started	1-4
System Overview	1-2
Using the System	2-2
Navigation DVD Radio with Bose® Surround Sound System (Acadia and Enclave Only)	3-18

O

Ordering	
Map DVDs	2-43
Overview, Navigation System	1-2
Owners, Canadian	iv

P

Park Aid	2-36
Playing a DVD	3-18
Playing the Radio	3-2
Problems with Route Guidance	2-42
Propriétaires Canadiens	iv

R

Radio	2-29, 3-2
Radio Data System (RDS)	3-9
Radio Menu	3-7
Rear Vision Camera	2-36

S

Scrolling the Map	2-6
Setting the Clock	1-7, 2-36
Sound	2-29
Sound Menu	3-5
Storing Radio Station Presets	1-7, 3-5
Symbols	2-7
System Needs Service, If	2-43

T

Touch-Sensitive Screen Buttons	2-3
--------------------------------------	-----

U

Using a Compressed Audio CD/DVD	3-13
Using Your Stored Preset Destinations	1-10

V

Vehicle Positioning	2-41
Video Screen, Cleaning	1-11
Voice Recognition	4-2
Voice Recognition Commands	4-3

X

XM™ Satellite Radio Service	3-9
-----------------------------------	-----