

# Panasonic®

## Operating Instructions

Microwave Oven  
Model NN-S758



This manual contains Safety Instructions, Operating Instructions and Maintenance of the oven.  
Before operating this oven, please read these instructions completely.  
Antes de operar este producto, lea este instructivo en su totalidad.  
El manual de instrucciones en español puede ser encontrada en la páginas 15-25.  
(Spanish Operating Instructions can be found on pages 15-25.)  
For Cooking Guide and Parts Order Form p. 14

Thank you for purchasing the Panasonic Microwave Oven.

## PRECAUTIONS TO AVOID POSSIBLE EXPOSURE TO EXCESSIVE MICROWAVE ENERGY

- (a) Do not attempt to operate this oven with the door open since open-door operation can result in harmful exposure to microwave energy. It is important not to defeat or tamper with the safety interlocks.
- (b) Do not place any object between the oven front face and the door, or allow soil or cleaner residue to accumulate on sealing surfaces.
- (c) Do not operate the oven if it is damaged. It is particularly important that the oven door close properly and that there is no damage to the:
  - (1) door (bent)
  - (2) hinges and latches (broken or loosened)
  - (3) door seals and sealing surfaces.
- (d) The oven should not be adjusted or repaired by anyone except properly qualified service personnel.

## Technical Specifications

	NN - S758
Power consumption:	13.0 Amps, 1500 W
Output:*	1100 W
Outside Dimensions (H x W x D):	14" x 23 <sup>7</sup> / <sub>16</sub> " x 16 <sup>3</sup> / <sub>4</sub> " (356 x 595 x 425mm)
Oven Cavity Dimensions (H x W x D):	10 <sup>11</sup> / <sub>16</sub> " x 17 <sup>3</sup> / <sub>16</sub> " x 15 <sup>9</sup> / <sub>16</sub> " (272 x 437 x 396mm)
Operating Frequency:	2,450 MHz
Uncrated Weight (Approx):	32 lbs. (14.5 kg)

\*IEC 705-88 Test procedure

Specifications subject to change without notice.

The serial number of this product may be found on the right side of the oven door opening. You should note the model number and the serial number of this oven in the space provided and retain this book as a permanent record of your purchase for future reference.

Model No. \_\_\_\_\_

Serial No. \_\_\_\_\_

Date of Purchase \_\_\_\_\_

# CONTENTS

## Before Operating

Precautions .....	Inside Front Cover
Important Safety Instructions .....	2
Installation Instructions .....	3
Grounding Instructions .....	3
Safety Precautions .....	4
Cookware and Utensil Guide .....	5
Feature Diagram .....	6
Control Panel .....	6

## Operation & Hints

Function Pad .....	6 - 7
To Set Clock .....	8
To Use Popcorn Pad .....	8
To Reheat using	
Power and Time Setting .....	8
Auto Reheat Pad .....	10
To Defrost using	
Power and Time Setting .....	8
Turbo Defrost Pad .....	10 - 11
To Cook using	
Power and Time Setting .....	8
Auto Cook .....	9
Quick Min .....	8
To Set Timer (Stand Time/Delay Start) .....	12
Quick Guide to Operation .....	Back Cover

## Maintenance

Before Requesting Service .....	13
Parts Order Form .....	14
Care of Your Microwave Oven .....	14
Technical Specifications .....	Inside Front Cover

## Manual de instrucciones (Spanish Operating Instructions)

Precauciones .....	15
Instrucciones de Seguridad .....	15 - 16
Instrucciones para Conexión a Tierra .....	16
Instrucciones de Instalación .....	17
Sugerencias Útiles .....	18
Diagrama de Características .....	19
Panel de Control .....	19
Procedimientos de Operación .....	20-24
Cuidados de Su Horno de Microondas .....	25
Antes de Acudir a Servicio .....	25

# IMPORTANT SAFETY INSTRUCTIONS

Your microwave oven is a cooking device and you should use as much care as you use with a stove or any other cooking device. When using this electric appliance, basic safety precautions should be followed, including the following:

**WARNING**—To reduce the risk of burns, electric shock, fire, injury to persons, or exposure to excessive microwave energy:

1. Read all instructions before using the appliance.
2. Read and follow the specific **"PRECAUTIONS TO AVOID POSSIBLE EXPOSURE TO EXCESSIVE MICROWAVE ENERGY,"** found inside of the front cover.
3. This appliance must be grounded. Connect only to properly grounded outlet. See **"GROUNDING INSTRUCTIONS"** found on page 3.
4. Install or locate this appliance only in accordance with the installation instructions found on page 3.
5. Do not cover or block any openings on this appliance.
6. Do not store or use this appliance outdoors. Do not use this product near water—for example, near a kitchen sink, in a wet basement, or near a swimming pool, and the like.
7. Use this appliance only for its intended use as described in this manual. Do not use corrosive chemicals or vapors in this appliance. This type of oven is specifically designed to heat, cook, or reheat food. It is not designed for industrial or laboratory use.
8. When cleaning surfaces of door and oven that come together on closing the door, use only mild, non-abrasive soaps or detergents applied with a sponge or soft cloth.
9. Do not allow children to use this appliance, unless closely supervised by an adult.
10. Do not operate this appliance if it has a damaged cord or plug, if it is not working properly, or if it has been damaged or dropped.
11. Do not immerse cord or plug in water.
12. Keep cord away from heated surfaces.
13. Do not let cord hang over edge of table or counter.
14. This appliance should be serviced only by qualified service personnel. Contact the nearest authorized service facility for examination, repair or adjustment.
15. Some products such as whole eggs and sealed containers—for example, closed glass jars—may explode and should not be heated in this oven.
16. To reduce the risk of fire in the oven cavity:
  - (a) Do not overcook food. Carefully attend appliance if paper, plastic, or other combustible materials are placed inside the oven to facilitate cooking.
  - (b) Remove wire twist-ties from paper or plastic bags before placing bag in oven.
  - (c) If materials inside the oven should ignite, keep oven door closed, turn oven off, and disconnect the power cord, or shut off power at the fuse or circuit breaker panel.

- (d) Do not use the cavity for storage purposes. Do not leave paper products, cooking utensils, or food in the cavity when not in use.

## General Use

1. **DO NOT** tamper with or make any adjustments or repairs to door, control panel housing, safety interlock switches or any other part of the oven. **DO NOT** remove outer panel from oven. Repairs should only be done by a qualified service person.

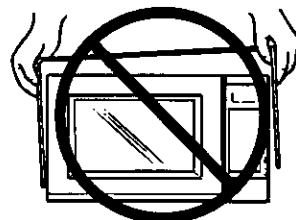

2. **DO NOT** operate the oven empty. The microwave energy will reflect continuously throughout the oven if food or water is not present to absorb energy. This could damage the oven and result in the danger of a fire.

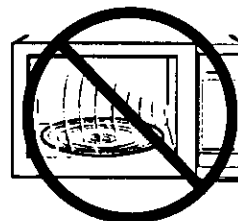

3. **DO NOT** use this oven to heat chemicals or any other non-food products. **DO NOT** clean this oven with any product that is labeled as containing corrosive chemicals. **The heating of corrosive chemicals in this oven can cause radiation leaks.**
4. **DO NOT** dry clothes, newspapers or other materials in oven. They may catch fire.
5. **DO NOT** use recycled paper products unless the paper product is labeled as safe for microwave oven use. Recycled paper products may contain impurities which may cause sparks and/or fires when used.
6. **DO NOT** use newspapers or paper bags for cooking. Fire can result.
7. **DO NOT** hit or strike control panel. Damage to controls may occur. Fire can result.
8. **POT HOLDERS** should always be used when removing items from the oven. Heat is transferred from the **HOT** food to the cooking container and from the cooking container to the Glass Tray. Glass Tray can be very **HOT** after removing cooking container from oven.
9. **DO NOT** store flammable materials next to, on top of, or in the oven. These could be fire hazards.

## SAVE THESE INSTRUCTIONS

For proper use of your oven read remaining safety cautions and operating instructions.

# INSTALLATION & GROUNDING INSTRUCTIONS

## Examine Your Oven

Unpack oven, remove all packing material, and examine the oven for any damage such as dents, broken door latches or cracks in the door. Notify dealer immediately if oven is damaged. **DO NOT** install if oven is damaged.

## Placement of Oven

- Oven must be placed on a flat, stable surface. For proper operation, the oven must have sufficient air flow. Allow 3 inches (8 cm) of space on both sides of the oven and 1 inch (2.5 cm) of space on top of oven.
  - DO NOT** block air vents. If they are blocked during operation, the oven may overheat. If the oven overheats, a thermal safety device will turn the oven off. The oven will remain inoperable until it has cooled.
  - DO NOT** place oven near a hot damp surface such as a gas or electric range.
  - DO NOT** operate oven when room humidity is too high.
- This oven was manufactured for household use only.

## Grounding Instructions

This appliance must be grounded. In the event of an electrical short circuit, grounding reduces the risk of electric shock by providing an escape wire for the electric current. This appliance is equipped with a cord having a grounding wire with a grounding plug. The plug must be plugged into an outlet that is properly installed and grounded.

**WARNING**—Improper use of the grounding plug can result in a risk of electric shock.

Consult a qualified electrician or service person if the grounding instructions are not completely understood, or if doubt exists as to whether the appliance is properly grounded. If it is necessary to use an extension cord, use only a three wire extension cord that has a three blade grounding plug, and a three slot receptacle that will accept the plug on the appliance. The marked rating of the extension cord should be equal to or greater than the electrical rating of the appliance.

## Power Supply

- A short power-supply cord is provided to reduce the risks resulting from becoming entangled in or tripping over a longer cord.
- Longer cord sets or extension cords are available and may be used if care is exercised in their use.
- If a long cord or extension cord is used, (1) the marked electrical rating of the cord set or extension cord should be at least as great as the electrical rating of the appliance, (2) the extension cord must be a grounding-type 3-wire cord, and (3) the longer cord should be arranged so that it will not drape over the counter top or tabletop where it can be pulled on by children or tripped over accidentally.

## Wiring Requirements

- The oven must be on a **SEPARATE CIRCUIT**. No other appliance should share the circuit with the microwave oven. If it does, the branch circuit fuse may blow, the circuit breaker may trip, or the food may cook slower than the times recommended in this manual.
- The **VOLTAGE** used must be the same as specified on this microwave oven (120 V). Using a higher voltage is dangerous and may result in a fire or other accident causing oven damage. Using a lower voltage will cause slow cooking. Panasonic is **NOT** responsible for damage resulting from the use of the oven with other than specified voltage.
- The oven must be plugged into at least a **20 AMP, 120 VOLT, 60 Hz GROUNDED OUTLET**. Where a standard two-prong outlet is encountered, it is the personal responsibility and obligation of the consumer to have it replaced with a properly grounded three-prong outlet.

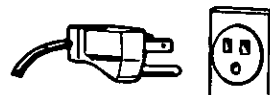

- A **TEMPORARY CONNECTION** with a two-prong adapter may be made where **LOCAL CODES PERMIT**. Unless the cover screw is grounded through the house wiring, attaching the adapter grounding plate to the cover screw will not ground the oven. If there is any doubt that the cover screw is grounded, have it checked by an electrician.



## Radio Interference

- Operation of the microwave oven may cause interference to your radio, TV or similar equipment.
- When there is interference, it may be reduced or eliminated by taking the following measures:
  - Clean door and sealing surfaces of the oven. (See Care of Your Microwave Oven found on page 14)
  - Place the radio, TV, etc. away from the microwave oven as far as possible.
  - Use a properly installed antenna to obtain stronger signal reception.

# Safety Precautions

## Follow These Safety Precautions When Cooking in Your Oven

### 1) HOME CANNING / DRYING FOODS / SMALL QUANTITIES OF FOODS

- **Do not** use your oven for home canning or the heating of any closed jar. Pressure will build up and the jar may explode. Your oven cannot maintain the food at the proper canning temperature. Improperly canned food may spoil and be dangerous to consume.
- Small quantities of food or foods with low moisture content can dry out, burn or catch on fire.
- **Do not** dry meats, herbs, fruits or vegetables in your oven.

### IMPORTANT

**Proper cooking depends on time set and weight of food. If you use a smaller portion than recommended and cook at the time for the recommended portion, fire can result.**

**If a fire occurs, turn oven off and leave oven door closed. Disconnect the power cord or shut off power at the fuse or circuit breaker panel.**

### 2) POPCORN

Popcorn must be popped in a microwave oven corn popper. Microwave popcorn which pops in its own package is also available. Follow popcorn manufacturers' directions and use a brand suitable for the wattage of your microwave oven. Never leave oven unattended when popping popcorn. Allow the popcorn bag to cool before opening it. To prevent steam burns, always open the bag away from your face and body.

#### CAUTION:

**When using pre-packaged microwave popcorn, follow recommended package instructions. Check package weight before using the *Popcorn* pad. Set the oven for the weight of the popcorn package. (see page 8) If these instructions are not followed, the popcorn may not pop adequately or may ignite and cause a fire.**

### 3) DEEP FAT FRYING

- **Do not** attempt to deep fat fry in your microwave oven. Cooking oils may burst into flames and may cause damage to the oven and perhaps result in burns. Microwave utensils may not be able to withstand the temperature of the hot oil, and could shatter.

### 4) EGGS

- **Do not** heat eggs in their shell in a microwave oven. Pressure will build up and the eggs will explode.

### 5) FOODS WITH NONPOROUS SKINS

- **Potatoes, apples, egg yolks, whole squash and sausages are examples of foods with nonporous skins.** These types of foods must be pierced before microwave cooking to prevent their bursting.
- Use fresh potatoes for baking and cook until just done. Overcooking causes dehydration and may cause a fire. Use recommended weights or fire may occur.

### 6) LIQUIDS

- Heated liquids can erupt if not mixed with air. **Do not** heat liquids in your microwave oven without first stirring.

### 7) GLASS TRAY / COOKING UTENSILS / FOIL

- Cooking utensils get hot during microwaving. Use potholders when removing utensils from the oven or when removing lids or plastic wrap covers from cooking utensils to avoid burns.
- The glass tray will get hot during cooking. It should be allowed to cool before handling or before paper products, such as paper plates or microwave popcorn bags, are placed in the oven for microwave cooking.
- When using foil, skewers, warming rack or utensils made of metal in the oven, allow at least 1-inch (2.5 cm) of space between metal material and interior oven walls. If arcing occurs (sparking) remove metal material (skewers etc.) and/or transfer to a non-metallic container.
- Dishes with metallic trim should **not** be used, as arcing may occur.

### 8) PAPER TOWELS / CLOTHS

- **Do not** use paper towels or cloths which contain a synthetic fiber woven into them. The synthetic fiber may cause the towel to ignite.
- **Do not** use paper bags or recycled paper products in the microwave oven.

### 9) BROWNING DISHES / OVEN COOKING BAGS

- Browning dishes or grills are designed for microwave cooking only. Always follow instructions provided by the manufacturer. Do not preheat browning dish more than 6 minutes.
- If an oven cooking bag is used for microwave cooking, prepare according to package directions. Do not use a wire twist-tie to close bag.

### 10) THERMOMETERS

- **Do not** use a conventional meat thermometer in your oven. Arcing may occur. Microwave-safe thermometers are available for both meat and candy.

### 11) BABY FORMULA / FOOD

- **Do not** heat baby formula or food in the microwave oven. The glass jar or surface of the food may appear warm while the interior can burn the infant's mouth and esophagus.

### 12) REHEATING PASTRY PRODUCTS

- When reheating pastry products, check temperatures of any fillings before eating. Some foods have fillings which heat faster and can be extremely hot while the surface remains warm to the touch (ex. Jelly Donuts).

### 13) GENERAL OVEN USAGE GUIDELINES

- **Do not** use the oven for any reason other than the preparation of food.
- **Do not** leave oven unattended while in use.

# Cookware and Utensil Guide

ITEM	MICROWAVE	COMMENTS
Aluminum Foil	Yes, for Shielding only	Small strips of foil can be molded around thin parts of meat or poultry to prevent overcooking. Arcing can occur if foil is too close to oven wall or if too much foil is used.
Browning Dish	Yes	Browning dishes are designed for microwave cooking only. Check browning dish information for instructions and heating chart. Do not preheat for more than 6 minutes.
Brown paper bags	No	May cause a fire in the oven.
Dinnerware Labelled "Microwave-Safe"	Yes	Check manufacturers' use and care directions for use in microwave heating. Some dinnerware may state on the back of the dish, "Oven-Microwave Safe".
Other Dinnerware	?	Use <b>CONTAINER TEST</b> below.
Disposable polyester Paperboard Dishes	Yes	Some frozen foods are packaged in these dishes. Can be purchased in grocery stores.
Fast Food Carton with Metal Handle	No	Metal handle may cause arcing.
Frozen Dinner Tray Metal	Yes	Frozen dinners may be heated in foil tray, if tray is less than 3/4-inch (2 cm) high. Place foil tray in center of oven. Leave at least 1-inch (2.5 cm) space between foil tray and oven walls. Heat only 1 foil tray in the oven at a time. For containers more than 3/4-inch (2 cm) deep, remove food and place in a similar size microwave-safe container.
Microwave-safe	Yes	
Glass Jars	Yes, use caution	Remove lid. Heat food until just warm, not HOT. Most glass jars are not heat resistant. Do not use for cooking.
Glassware Heat Resistant Oven Glassware & Ceramics	Yes	Ideal for microwave cooking and browning. (See <b>CONTAINER TEST</b> below)
Metal Bakeware	No	Not recommended for use in microwave ovens.
Metal Twist Ties	No	May cause arcing which could cause a fire in the oven.
Oven Cooking Bag	Yes	Follow manufacturers' directions. Close bag with the nylon tie provided, a strip cut from the end of the bag, or a piece of cotton string. Do not close with metal twist tie. Make six 1/2-inch (1 cm) slits near the closure.
Paper Plates & Cups	Yes	Use to warm cooked foods, and to cook foods that require short cooking times such as hot dogs.
Paper Towels & Napkins	Yes	Use to warm rolls and sandwiches by microwave.
Parchment Paper	Yes	Use as a cover to prevent spattering. Safe for use in microwave, microwave/convection and conventional ovens.
Plastic Microwave-Safe Cookware	Yes	Should be labeled, "Suitable for microwave heating." Check manufacturers' directions for recommended uses.  Some microwave-safe plastic dishes are not suitable for cooking foods with high fat or sugar content. The heat from hot food may cause the plastic to warp.
Reheat & Storage	Yes, use caution	
Melamine	No	
Plastic Foam Cups	Yes	Plastic foam will melt if foods reach a high temperature. Use to bring foods to a low serving temperature.
Plastic Wrap	Yes	Use to cover food during cooking to retain moisture and prevent spattering. Should be labelled "Suitable for Microwave Heating". Check package directions.
Straw, Wicker, Wood	Yes	Use only for short term reheating and to bring food to a low serving temperature.
Thermometers Microwave-safe, only Conventional	Yes No	Use only microwave-safe meat and candy thermometers. Not suitable for use in microwave oven, will cause sparks and get hot.
Wax paper	Yes	Use as a cover to prevent spattering and to retain moisture.

## CONTAINER TEST

TO TEST A CONTAINER FOR SAFE MICROWAVE OVEN USE: Fill a 1-cup glass measure with water and place it in the microwave oven along with the container to be tested; **heat one (1) minute at HIGH**. If the container is microwave oven-safe, the container should remain comfortably cool and the water should be hot. If the container is hot, it has absorbed some microwave energy and should NOT be used. This test cannot be used for plastic containers.

# Features

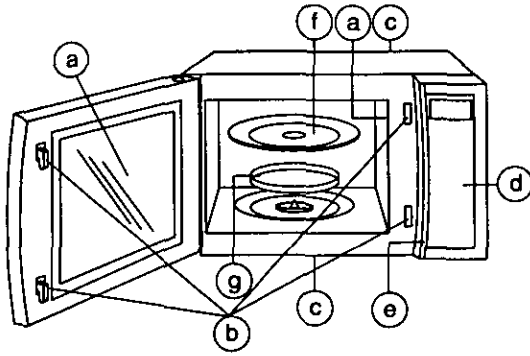

- (a) Vapor Barrier Film (do not remove)
- (b) Door Safety Lock System
- (c) External Air Vents
- (d) Control Panel
- (e) Identification Plate
- (f) Glass Tray
- (g) Roller Ring

# Control Panel

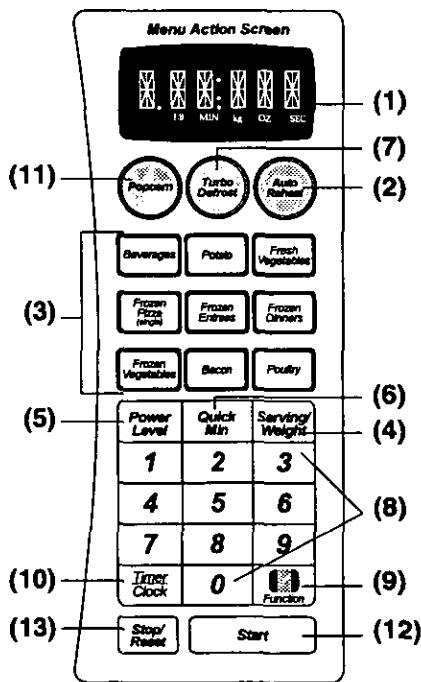

- (1) Menu Action Screen-Display
- (2) Auto Reheat Pad
- (3) Auto Cook Pads
- (4) Serving/Weight Pad
- (5) Power Level Pad
- (6) Quick Min Pad
- (7) Turbo Defrost Pad
- (8) Number Pads
- (9) Function Pad
- (10) Timer/Clock Pad
- (11) Popcorn Pad
- (12) Start Pad:

One tap allows oven to begin functioning. If door is opened or **Stop/Reset** Pad is pressed once during oven operation, **Start** Pad must be pressed again to restart oven.

### (13) Stop/Reset Pad:

**Before cooking:** One tap clears your instruction.

**During cooking:** One tap temporarily stops the cooking process. Another tap cancels all your instructions and time of day appears on the display screen.

# To Use Function Pad

1)		Press. The Menu Action Screen will prompt the next action.
2)		Select choice <input type="text" value="0"/> - <input type="text" value="9"/> using the number pads
3)	<input type="text" value="1"/> <input type="text" value="2"/> <input type="text" value="3"/>	Select option <input type="text" value="1"/> , <input type="text" value="2"/> or <input type="text" value="3"/>
4)	Repeat steps 1-3.	For other options, see page 7.



# Functions

This unique feature of your PANASONIC microwave oven allows you to establish the initial non-cooking features of your oven such as CHILD LOCK, WORD SPEED, LANGUAGE CHOICE (ENGLISH, SPANISH OR FRENCH), plus many more. See below.





→ 1	<p><b>LANGUAGE CHOICE</b></p> <p>The oven has English, French and Spanish display. The display appears in English when you plug-in.</p> <p>1 ENGLISH → Display appears in English.            2 FRANCAIS → Display appears in French.            3 ESPANOL → Display appears in Spanish.</p>
→ 2	<p><b>Lb/KG CHOICE</b></p> <p>The oven has both imperial and metric weight measurements. The oven displays the weight in imperial when you plug it in.</p> <p>1 Lb → Weight can be set in oz/lb.            2 KG → Weight can be set in g/kg.</p>
→ 3	<p><b>WORD SPEED</b></p> <p>The speed of word scrolling in the Display Window can be quickened or slowed down.</p> <p>1 QUICK → Words scroll quickly.            2 MEDIUM → Scrolling speed reverts to initial setting.            3 SLOW → Words scroll slowly.</p>
→ 4	<p><b>MENU ACTION ON/OFF</b></p> <p>MENU ACTION SCREEN helps you to program your oven by prompting the next step to be taken. When you become familiar with your oven, the prompting can be turned off.</p> <p>1 ON → Prompting Guide will reappear.            2 OFF → Prompting Guide will not appear.</p>
→ 5	<p><b>CHILD LOCK ON/OFF</b></p> <p>The oven has Child Safety Lock feature which prevents use by children.</p> <p>1 ON → Child Lock has been set and operation will not be accepted.            2 OFF → Child Lock has been cancelled.</p>
→ 6	<p><b>BEEP ON/OFF</b></p> <p>If you wish to have the oven operate with no beep, it can be eliminated.</p> <p>1 ON → Beep sound will reactivate.            2 OFF → Beep sound will not be heard.</p>
→ 7	<p><b>REMINDER BEEP ON/OFF</b></p> <p>A reminder beep works to remind you to remove the food from the oven after the completion of cooking. It will occur every few seconds.</p> <p>1 ON → Reminder beep will work.            2 OFF → Reminder beep will not work.</p>
→ 8	<p><b>DAYLIGHT SAVING ON/OFF</b></p> <p>1 ON → Time of day will advance one hour.            2 OFF → Time of day reverts to original setting.</p>
→ 9	<p><b>CLOCK ON/OFF</b></p> <p>Clock display can be turned off.</p> <p>1 ON → Clock display will appear in the Display Window.            2 OFF → Clock display will not appear in the Display Window.            Time of day will not be lost while the display is off.</p>
→ 0	<p><b>DEMO MODE ON/OFF</b></p> <p>Demo mode is designed for retail store display. In this mode, the oven can be demonstrated with no power in the oven.</p> <p>1 ON → The oven will be in demo mode.            2 OFF → The oven will be out of demo mode.</p>

## Clock Setting

You can use the oven without setting the clock.

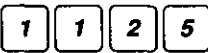
**Example: To set 11:25 a.m. or p.m.**



1. 	<ul style="list-style-type: none"> <li>Press twice.</li> <li>▶ Colon will blink.</li> </ul>
2. 	<ul style="list-style-type: none"> <li>Enter time of day using the number pads.</li> <li>▶ Time appears on the screen; colon is blinking.</li> </ul>
3. 	<ul style="list-style-type: none"> <li>Press.</li> <li>▶ Colon stops blinking; time of day is entered and locked onto the screen.</li> </ul>

### NOTES:

- To reset time of day, repeat step 1 through step 3.
- The clock will keep the time of day as long as oven is plugged in and electricity is supplied.
- If the area you live in adjusts their clock either forward or backward during the year, see the feature on **Function PAD #8** (page 7) for easy adjustment.

## Popcorn Function

**Example: To heat 3.5 oz. of Popcorn**

1.  Press once	<ul style="list-style-type: none"> <li>Set the desired weight of prepackaged microwave popcorn.</li> </ul> <table border="1"> <thead> <tr> <th>Press</th> <th>Weight</th> </tr> </thead> <tbody> <tr> <td>once</td> <td>3.5 oz. (99 g)</td> </tr> <tr> <td>twice</td> <td>3.0 oz. (90 g)</td> </tr> <tr> <td>3 times</td> <td>1.75 oz. (50 g)</td> </tr> </tbody> </table>	Press	Weight	once	3.5 oz. (99 g)	twice	3.0 oz. (90 g)	3 times	1.75 oz. (50 g)
Press	Weight								
once	3.5 oz. (99 g)								
twice	3.0 oz. (90 g)								
3 times	1.75 oz. (50 g)								
2. 	<ul style="list-style-type: none"> <li>Press.</li> <li>▶ Cooking time appears and begins to count down.</li> </ul>								

### NOTES ON POPCORN PAD:



- Use prepackaged **room temperature** microwave popcorn. Read manufacturers' instructions.
- Place bag in oven according to manufacturers' directions.
- Pop only one bag at a time.
- After popping, allow the contents of the bag to cool for a few minutes before opening. Open bag carefully away from face and body because popcorn and steam are extremely hot.
- Do not reheat unpopped kernels or reuse bag.
- NEVER** leave oven unattended when popping popcorn.

**CAUTION:** If prepackaged popcorn is of a different weight than the recommended weight, do not use the popcorn setting, or inadequate popping or a fire may occur. Follow the manufacturers' instructions.

## Power & Time Setting

How do I program Power and Time?

**Example: To cook at MEDIUM Power for 1 minute 30 seconds**

1.  4 times = Med.	<ul style="list-style-type: none"> <li>Select <b>Power Level</b>. (according to the chart below)</li> </ul>
2.  1:30	<ul style="list-style-type: none"> <li>Set Cooking Time using number pads. (up to 99 minutes and 99 seconds for a single stage)</li> </ul>
3. 	<ul style="list-style-type: none"> <li>Press.</li> <li>▶ Cooking will start. The time on the screen will begin to count down.</li> </ul>

Press	Power Level	% Power
once	P100 (HIGH)	100%
twice	DEF (DEFROST)	30%
3 times	P 70 (MEDIUM-HIGH)	70%
4 times	P 50 (MEDIUM)	50%
5 times	P 30 (MEDIUM-LOW)	30%
6 times	P 10 (LOW)	10%



### NOTES:

- For 2 or 3 stage cooking, repeat steps 1 and 2 above before pressing **Start** Pad.
- When selecting HIGH Power on the first stage, you can start from step 2.
- At the end of the cooking sequence, the oven will sound 5 beeps.

## Quick Min Function

This feature helps you in programming your oven without pressing Number Pads and allows you to add extra cooking time easily.

### To Set Cooking Time:

1. 	<ul style="list-style-type: none"> <li>Set cooking time (up to 10 taps/minutes)</li> </ul>
2. 	<ul style="list-style-type: none"> <li>Press</li> <li>▶ Cooking will start on HIGH power.</li> </ul>

### NOTE:



- You can use other power levels, select the desired power level before setting the cooking time.
- After setting the time by **Quick Min** Pad, you cannot use Number Pads, and vice versa.

# Auto Cook

## Using the Auto-Cook Programs

These are tested and pre-timed (based on the power rating of this oven) for the quantity of food listed in the chart below. Locale, power fluctuations and personal tastes are not taken into account. Should you prefer your food cooked differently, use power and time method shown on page 8.

**Example:** To cook a 10 oz. Frozen Entree.

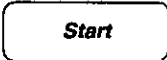
1.		Press.
2.	 select 10 oz.	Press the <b>Serving/Weight</b> pad until the desired quantity appears on the Display Window.
3.		Press the <b>Start</b> pad. The time for cooking will appear in the Display Window and count down. Simply open the door to stir or to rearrange the food as per the directions.

The following are the recommended servings / weights.



### AUTO COOK CODES

PAD	CATEGORY	SERVING/WEIGHT	HINTS
<i>Beverages</i>	COFFEE/TEA	1 or 2 cups (6 - 7 oz serving)	DO NOT heat liquids in your microwave oven without stirring first. Heated liquids can erupt if not mixed with air.
	SOUP	1, 2 servings (8 oz serving)	Use a water based soup.
<i>Potato</i>		1-4 (6-8 oz each)	Pierce skin with a fork, arrange in a circle.
<i>Fresh Vegetables</i>		4, 8, 12, 16 oz (110,225,340,450 g) For best results, pieces should be the same size	Cover with a lid or plastic wrap. Add small amount of water. Stir occasionally during cooking. Let stand, covered 3-5 minutes before serving.
<i>Frozen Pizza (single)</i>		4, 8 oz (110, 225 g)	Follow package directions. Place pizza on crisper shield.
<i>Frozen Entrees</i>		8,10,20,32 oz (225,300,600,900 g)	Follow manufacturers' directions for covering or removing covers. For best results, do not use frozen foods packaged in foil trays. Halfway through cooking, rearrange or stir.
<i>Frozen Dinners</i>		11, 15 oz (300, 430 g)	Follow manufacturers' directions for covering or removing covers. For best results, do not use frozen foods packaged in foil trays. Halfway through cooking, rearrange or stir.
<i>Frozen Vegetables</i>		5, 10, 16 oz (150, 300, 450 g)	Follow package directions or place in microwave dish, add water and cover with plastic wrap.
<i>Bacon</i>		2,3,4,6 slices	Place on microwave safe dish and cover with paper towels.
<i>Poultry</i>	CHICKEN PIECES	6,12,18,24 oz (170,340,500,680 g)	Place skin-side up. Cover with plastic wrap.
	WHOLE CHICKEN	3.5, 4.0, 5.0, 5.5 lb (1.5, 1.8, 2.2, 2.5 kg)	Place breast-side down. Cover with plastic wrap. Turn to breast-side up halfway through cooking.

## Auto Reheat

This feature allows you to reheat 1 to 4 servings of precooked room temperature and refrigerator temperature foods without setting power and time.

**Example: To reheat 2 cups of soup**

<b>1.</b>  Press twice	<ul style="list-style-type: none"> <li>• Press until the desired number of servings appears on the screen.</li> </ul>
<b>2.</b> 	<ul style="list-style-type: none"> <li>• Press.</li> <li>➤ Cooking time appears on the screen and begins to count down.</li> </ul>

### NOTES:

1. **Auto Reheat** can be programmed for 1 to 4 servings.
2. The following are the recommended food items and approximate weights.

Foods	Number of Servings	Serving Size	Starting Temp.
Plate of Food	1 - 4	4 oz./serv.	Refrig.
Meat, Poultry	1 - 4	4 to 6 oz.	Refrig.
Casseroles	1 - 2	8 oz.	Refrig. or Room
Side Dishes	1 - 4	4 to 6 oz.	Refrig. or Room
Soups, Sauces Gravy	1 - 2	4 to 6 oz.	Refrig. or Room



### For best results, follow these recommendations:

1. All foods must be previously cooked.
2. Foods should always be covered loosely with plastic wrap, wax paper or casserole lid.
3. All foods should have a covered stand time of 3 to 5 minutes.
4. **DO NOT** reheat bread and pastry products. Use manual power and time.
5. **DO NOT** reheat beverages.

## Turbo Defrost

This feature allows you to defrost meat, poultry and seafood by weight without setting time.

**Example: To defrost 1.5 lb. of meat (1 lb. 8 oz.)**

<b>1.</b> 	<ul style="list-style-type: none"> <li>• Press.</li> </ul>
<b>2.</b> 	<ul style="list-style-type: none"> <li>• Enter the weight of the food using the number pads. Weight must be programmed in pounds and ounces. (See conversion chart below.)</li> </ul>
<b>3.</b> 	<ul style="list-style-type: none"> <li>• Press.</li> <li>➤ Defrosting time appears on the screen and begins to count down.</li> </ul>

### Conversion Chart:

Follow this chart to convert ounces or hundredths of a pound into tenths of a pound.

If a piece of meat weighs 1.95 pounds, the equivalent is 1 pound 14 ounces.

Ounces	Hundredths of a Pound	Tenths of a Pound
0	.96 - .05	0.0
1 - 2	.06 - .15	0.1
3 - 4	.16 - .25	0.2
5	.26 - .35	0.3
6 - 7	.36 - .45	0.4
8	.46 - .55	0.5
9 - 10	.56 - .65	0.6
11 - 12	.66 - .75	0.7
13	.76 - .85	0.8
14 - 15	.86 - .95	0.9

# Defrosting Tips & Techniques



1. Freeze meats, poultry and fish in packages with **only 1 or 2 layers** of food. Place wax paper between layers.
2. **Package** in heavy-duty plastic wraps, bags or freezer paper.
3. **Remove as much air** as possible.
4. Wrap should be snug against food, sealed securely and labeled.
5. **Remove wrapper** to prevent holding steam and juice. **Juice of food** can get hot and cause the outer surface or bottom of the food to cook; set the food on a microwave roasting rack and drain liquid during defrosting.
6. **Place meat in an appropriate size dish.**
7. **Place roast fat-side down** and **whole poultry breast-side down** on a microwave roasting rack in a dish.
8. Place small items on a microwave roasting rack in a dish.
9. **Large roasts** and **whole poultry** may still be icy in center after defrosting, allow to stand in the refrigerator covered with plastic wrap (see chart below).
10. Fish and seafood should be slightly icy after defrosting, allow to stand and rinse under cold water for 2-3 minutes.
11. Defrosted items in 2 layers should be **rinsed separately** or **have a longer stand time.**

FOOD	DEFROST TIME (min. per pound)	DURING DEFROSTING	AFTER DEFROSTING	
			Stand Time	Rinse
<b>Fish and Seafood</b> [up to 3 lb. (1.5 kg)]				
Crabmeat	12 to 14	Break apart	5 min.	NO
Fish Steaks	6 to 10	Turn over		
Fish Fillets	6 to 8	Turn over/Rearrange		
Sea Scallops	14 to 16	Break apart/Remove defrosted pieces	5 min.	YES
Shrimp medium	8 to 10	Break apart/Remove defrosted pieces		
Whole fish	10 to 12	Turn over		
<b>Meat</b>				
Ground Meat	8 to 10	Turn over/Remove defrosted portion/Shield edges	10 min.	NO
Roasts [2½ - 4 lb. (1.2 - 2 kg)]	8 to 12	Turn over/Shield ends and defrosted surface	30 min. in refrig	
Chops/Steak	8 to 10	Separate/Turn over/Rearrange	5 min.	
Ribs/T-bone	8 to 10	Turn over/Shield		
Stew Meat	10 to 12	Break apart/Shield		
Liver (thin sliced)	8 to 10	Drain liquid/Turn over/Separate pieces		
Bacon	4 to 6	Turn over		
<b>Poultry</b>				
Chicken, Whole [up to 3 lb. (1.5 kg)]	6 to 10	Turn over 2 or 3 times/Shield defrosted parts	20 min. in refrig	YES
Cutlets	6 to 8	Turn over	5 min.	NO
Pieces	8 to 10	Separate	10 min.	
Cornish Hens	8 to 12	Turn over/Rearrange		
Turkey Breast [5 - 6 lbs. (2.5 - 3 kg)]	8 to 12	Turn over 2 to 3 times	20 min. in refrig	



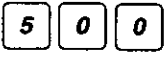

# Timer Setting

This feature allows you to program a Standing Time after cooking is completed, to program the oven as a minute timer and/or to program a delay start.





## To Use as a Kitchen Timer:

Example: To count 5 minutes	
1. 	• Press.
2. 	• Enter desired amount of time using the number pads (up to 99 minutes and 99 seconds).
3. 	• Press. ▶ Time will count down without oven operating.

## To Set Stand Time:

Example: To stand for 5 minutes after cooking (3 mins. at MEDIUM Power)	
1.  4 times ↓ 	• Enter the desired cooking program (see page 8 for directions).
2. 	• Press once.
3. 	• Set desired amount of Stand Time using the number pads (up to 99 minutes and 99 seconds).
4. 	• Press. ▶ Cooking will start. After cooking, stand time will count down without oven operating.

## To Set Delay Start:

Example: To start cooking 5 minutes later (3 mins. at MEDIUM Power)	
1. 	• Press once.
2. 	• Enter desired amount of delayed time using the number pads (up to 99 minutes and 99 seconds).
3.  ↓ 	• Enter the desired cooking program (see page 8 for directions).
4. 	• Press. ▶ Delayed time will count down. Then cooking will start.

### NOTES:

1. If oven door is opened during Stand Time or Kitchen Timer, the time on the screen will continue to count down.
2. Delay Start cannot be programmed before any Auto Control Function.  
This is to prevent the starting temperature of the food from rising before defrosting or cooking begins. A change in the starting temperature could cause inaccurate results.

# Before Requesting Service

## All these things are normal:

The oven causes interference with my TV.

Some radio and TV interference might occur when you cook with the microwave oven. This interference is similar to the interference caused by small appliances such as mixers, vacuums, blow dryers, etc. It does not indicate a problem with your oven.

The oven lights dim.

When cooking with a power other than HIGH, the oven must cycle to obtain the lower power levels. The oven light will dim and clicking noises can be heard when the oven cycles.

Steam accumulates on the oven door and warm air comes from the oven vents.

During cooking, steam and warm air are given off from the food. Most of the steam and warm air are removed from the oven by the air which circulates in the oven cavity. However, some steam will condense on cooler surfaces such as the oven door. This is normal.

I accidentally ran my microwave oven without any food in it.

Running the oven empty for a short time will not damage the oven. However, we do not recommend operating the microwave oven without any food in it.

### PROBLEM

### POSSIBLE CAUSE

### REMEDY

Oven will not turn on.

The oven is not plugged in securely.

Remove plug from outlet, wait 10 seconds and reinsert.

Circuit breaker or fuse is tripped or blown.

Reset circuit breaker or replace fuse.

There is a problem with the outlet.

Plug another appliance into the outlet to check if it is working.

Oven will not start cooking.

The door is not closed completely.

Close the oven door securely.

**Start** Pad was not pressed after programming.

Press **Start** Pad.

Another program entered already in the oven.

Press **Stop/Reset** Pad to cancel the previous program and program again.

The program is not correct.

Program again according to the Operating Instructions.

**Stop/Reset** Pad has been pressed accidentally.

Program oven again.

The words "DEMO MODE" appear on the screen.

DEMO MODE was activated by the **Function** pad.

Deactivate mode by using **Function** pad (p. 8 - 9).

When the oven is turning on, there is noise coming from the glass tray.

The roller ring and oven bottom are dirty.

Clean these parts according to Care of Your Oven (next page).

If you have any questions or it seems there is a problem with the oven, contact PANASONIC CUSTOMER CALL CENTER for assistance.  
1-800-211-PANA(7262) (9 a.m. - 9 p.m., E.S.T., toll free).

# Care of Your Microwave Oven

## BEFORE CLEANING:

Unplug at socket of the oven. If impossible, leave oven door open to prevent oven from accidentally turning on.

## AFTER CLEANING:

Be sure to replace the Roller Ring and Glass Tray in the proper position and press **Stop/Reset** Pad to clear the screen.

### Inside of the oven:

Wipe with a damp cloth. Mild detergent may be used if the oven gets very dirty. The use of harsh detergent or abrasives is not recommended.

### Glass Tray:

Remove and wash in warm soapy water or in a dishwasher.

### Outside oven surfaces.

Clean with a damp cloth. To prevent damage to the operating parts inside the oven, water should not be allowed to seep into ventilation openings.

### Control Panel:

\* Covered with a removable protective film to prevent scratches during shipping. Small bubbles may appear under this film.

*(Hint - To remove film, apply masking or clear tape to an exposed corner and pull gently.)*

\* If the control panel becomes wet, clean it with a soft dry cloth. Do not use harsh detergents or abrasives on the Control Panel.

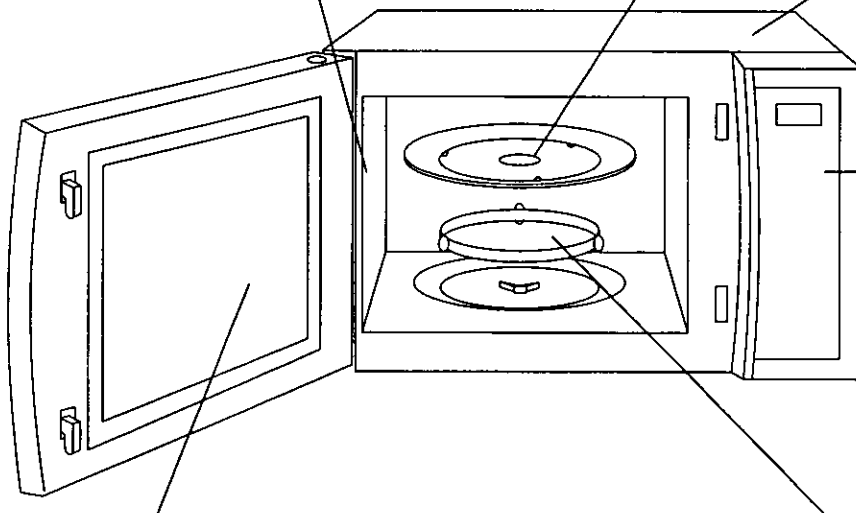

### Oven Door:

Wipe with a soft cloth when steam accumulates inside or around the outside of the oven door. During cooking, especially under high humidity conditions, steam is given off from the food. (Some steam will condense on cooler surfaces, such as the oven door.) This is normal.

### Roller Ring and oven cavity floor:

Wipe the bottom surface of the oven with mild detergent water or window cleaner and dry. Roller Ring may be washed in mild soapy water or dishwasher. These areas should be kept clean to avoid excessive noise.

## ORDER FORM

For more information regarding microwave cooking, order our new **COOKING GUIDE** (68 pages of recipes & charts).

DESCRIPTION	PART NUMBER	PRICE
Instruction / Operating Manual (this book)	B00034A2AAP	①
COOKING GUIDE	B000B8250AP	\$9.49
Glass Tray (see <b>Care of Your Microwave Oven</b> above)	A06014000AP	\$24.31
Roller Ring Assembly (see <b>Care of Your Microwave Oven</b> above)	B290D9330AP	①

① For pricing quotes, call or write the Parts & Literature Department at the phone or address listed below. Please have your credit card information readily available.

*Shipping & handling are not included. Price & availability subject to change. Sorry, no COD's.*

PANASONIC SERVICES COMPANY  
20421 84th Avenue South  
Kent, WA 98032

(800) 833-9626 - Phone  
(800) 237-9080 - FAX



# INSTRUCCIONES DE SEGURIDAD

Su horno de microondas es un artículo para cocinar y usted debe usarlo con tanto cuidado como usa una estufa o cualquier otro artículo para cocinar.

Cuando utilice este aparato eléctrico, se deben seguir precauciones básicas de seguridad, incluyendo las siguientes:

**PRECAUCION** - Para reducir el riesgo de quemaduras, descarga eléctrica, incendio, heridas a personas o exposición excesiva a energía de microondas:

1. Lea todas las instrucciones antes de usar el aparato.
2. Lea y siga las **"PRECAUCIONES PARA EVITAR POSIBLE EXPOSICION EXCESIVA A ENERGIA DE MICROONDAS"** específicas, que se encuentran abajo.
3. Este aparato debe ser conectado a tierra. Conecte solamente a la toma eléctrica debidamente conectada a tierra. Vea las **"INSTRUCCIONES PARA CONEXIÓN A TIERRA"** que se encuentran en la página 16.
4. Instale o ubique este aparato solamente de acuerdo con las instrucciones de instalación que se encuentran en la página 17.
5. No cubra ni tape ninguna de las rendijas de este aparato.
6. No almacene o use este aparato en exteriores. No use este aparato cerca del agua - por ejemplo, cerca del fregadero de la cocina, en una base mojada, o cerca de una alberca, y similares.
7. Use este aparato sólo para los fines para los que fué hecho, tal como se describen en este manual. No use químicos o vapores corrosivos en este aparato. Este tipo de horno está específicamente diseñado para calentar o cocinar alimentos. No fué diseñado para uso industrial o de laboratorio.
8. Cuando limpie las superficies de la puerta y el horno que vienen juntas al cerrar la puerta, use solamente jabones no abrasivos o detergentes suaves aplicados con una esponja o con tela suave.
9. No permita a los niños usar este aparato, a menos que sean supervisados muy de cerca por un adulto.
10. No use este aparato si tiene dañado el cordón o la clavija, si no está trabajando adecuadamente, o si ha sido dañado o se ha dejado caer.
11. No sumergir en agua el cable o la clavija.
12. Mantenga el cordón lejos de superficies calientes.
13. No deje el cordón colgando en el borde de la mesa o mostrador.
14. Este aparato debe recibir mantenimiento sólo de personal calificado. Contacte las instalaciones de servicio autorizadas más cercanas para revisión, reparación o ajuste.
15. Algunos productos, tales como los huevos completos y contenedores sellados - por ejemplo frascos de vidrio cerrados - pueden explotar y no deben ser calentados en este horno.
16. Para reducir el riesgo de incendio en la cavidad del horno:
  - (a) No sobrecocine los alimentos. Preste atención cuidadosamente al aparato. El papel, plástico u otros materiales combustibles son colocados dentro del horno para facilitar la cocción pero si no se utilizan adecuadamente esto puede producir incendio en su horno.
  - (b) Quite los sujetadores de alambre de las bolsas de papel o plástico antes de colocar la bolsa en el horno.
  - (c) Si los materiales dentro del horno se incendiaron, mantenga cerrada la puerta del horno, póngalo en posición de apagado, y desconecte la energía eléctrica, o corte el suministro eléctrico en la caja de fusibles o en el panel de control.
  - (d) No use la cavidad con propósitos de almacenaje. No deje productos de papel, utensilios de cocina o alimentos en la cavidad cuando no esté en uso.

## Guarde estas instrucciones

### PRECAUCIONES PARA EVITAR POSIBLE EXPOSICION EXCESIVA A ENERGIA DE MICROONDAS

- (a) No intente hacer funcionar este horno con la puerta abierta ya que esto puede resultar peligroso. Es importante no anular o biogear los mecanismos de seguridad.
- (b) No coloque ningún objeto entre el panel frontal del horno y la puerta, ni permita que se acumule basura o residuos de limpiadores en las superficies de sellado.
- (c) No haga funcionar el horno si está dañado, es importante que la puerta del horno abra y cierre apropiadamente:
  - (1) la puerta (combada)
  - (2) bisagras y seguro de la puerta (rotos o sueltos)
  - (3) sellos de las puertas y superficies de sellado
- (d) El horno o deberá ser ajustado o reparado por ninguna persona, excepto el personal de servicio debidamente calificado.

# INSTRUCCIONES DE SEGURIDAD

## Uso General

1. **NO** altere o haga ningún ajuste o reparación a la puerta, al alojamiento del panel de control, interruptores entrecruzados de seguridad o a cualquier otra parte del horno. **NO** quite el panel exterior del horno. Las reparaciones deben ser hechas solamente por personal de servicio calificado.
2. **NO** opere el horno vacío. La energía de microondas se reflejará continuamente a través del horno si los alimentos o agua no están presentes para absorber energía. Esto puede dañar el horno y resultar en peligro de incendio.
3. **NO** utilice este horno para calentar químicos o cualquier otros productos no alimenticios. **NO** limpie este horno con cualquier producto etiquetado con contenido químico corrosivo. El calentamiento de químicos corrosivos en este horno puede causar fugas de radiación.
4. **NO** seque telas, periódicos u otros materiales en el horno. Pueden incendiarse.
5. **NO** use productos de papel reciclado, ya que pueden contener impurezas que pueden causar chispas y/o incendios cuando se usen.
6. **NO** use periódicos o bolsas de papel para cocinar. Puede causar un incendio.
7. **NO** pegue, **NO** golpee el panel de control. Pueden causarse daños a los controles. Puede causar un incendio.
8. Las manoplas para tomar cosas calientes siempre deben ser utilizados cuando se retiren cosas de el horno. El calor se transfiere de los alimentos calientes a los contenedores para cocinar y de los contenedores a la Bandeja de Cristal. La Bandeja de Cristal puede estar muy caliente después de sacar los contenedores para cocinar del horno.
9. **NO** almacene materiales flamables cerca, arriba, o dentro del horno. Pueden ser riesgos de incendio.

# INSTRUCCIONES PARA CONEXION A TIERRA

Este aparato debe ser conectado a tierra. En el caso de un corto circuito, la conexión a tierra reduce el riesgo de una descarga eléctrica proporcionando una línea de escape para la corriente eléctrica. Este aparato está equipado con un cable y clavija para conexión a tierra. La clavija debe ser conectada en un receptor que esté instalado adecuadamente y conectado a tierra.

**PRECAUCION** - El uso inapropiado de la clavija para conexión a tierra puede resultar en riesgo de descarga eléctrica.

Consulte a un electricista o a personal de servicio calificados, si las instrucciones para conectar a tierra no son completamente comprendidas o si existe duda de que el aparato está correctamente conectado a tierra. Si es necesario usar un cable de extensión, use solamente cable de extensión de tres hilos que tenga una clavija de tres entradas para conectar a tierra, y un receptor de tres ranuras que acepte la clavija del aparato. El calibre marcado en el cable de extensión debe ser igual o mayor al calibre eléctrico del aparato.

## Suministro Eléctrico

1. Se provee un cable de suministro eléctrico corto para reducir los riesgos resultantes de enredarse o tropezarse con un cable más largo.
2. Juegos de cable más largos o extensiones están disponibles y pueden utilizarse si se usan con cuidado.
3. Si se usa un cable más largo o extensión, (1) el calibre eléctrico marcado en el juego de cordón o extensión debe ser al menos tan grande como el calibre eléctrico del aparato, (2) el cable de extensión debe ser de tres hilos del tipo de conexión a tierra, y (3) el cordón más largo debe ser arreglado de tal forma que no caiga sobre la cubierta del mostrador o de la mesa donde pueda ser jalado por niños o tropezarse accidentalmente.

# INSTRUCCIONES DE INSTALACION

## Examine Su Horno

Desempaque el horno, quite todo el material de empaque y examine que su horno no tenga ningún daño, tales como abolladuras, seguros de la puerta rotos o resquebrajaduras en la puerta. Notifique inmediatamente a su distribuidor si el horno está dañado.



## Ubicación del Horno

1. El horno debe ser colocado en una superficie plana y estable. Para su operación apropiada, el horno debe tener suficiente corriente de aire. Deje 8 cm de espacio de ambos lados del horno y 2.5 cm de espacio en la parte superior del horno.
  - a. **NO** tape las ventilas de aire. Si están tapadas durante su operación, el horno puede sobrecalentarse. Si se sobrecalienta, un dispositivo térmico de seguridad apagará el horno. El horno no operará hasta que se haya enfriado.
  - b. **NO** coloque el horno cerca de una superficie húmeda caliente, tal como un registro de gas o eléctrico.
  - c. **NO** opere el horno cuando la humedad del cuarto sea muy alta.
2. Este horno ha sido fabricado para uso en el hogar solamente.

## Interferencia de Radio

1. La operación de su horno de microondas puede causar interferencia en su radio, TV o equipo similar.
2. Cuando hay interferencia, se puede reducir o eliminar tomando las siguientes medidas:
  - a. Limpie la puerta y las superficies selladoras del horno. (Vea Cuidados de Su Horno de Microondas que se encuentran en la página 25)
  - b. Ponga el radio, TV, etc. lo más lejos posible del horno de microondas.
  - c. Use una antena instalada adecuadamente para obtener una recepción de señal más fuerte.

## Requerimientos de cableado

1. El horno debe estar en un circuito separado. Ningún otro aparato debe compartir el circuito con el horno. Si lo hace el fusible del circuito puede estallar, el bloqueador del circuito trabarse o la comida cocinarse más lento que en los tiempos recomendados en este manual.
2. El voltaje usado debe ser el mismo al especificado en el horno de microondas (120 V.). Usar un voltaje más alto es peligroso y puede resultar en fuego u otro accidente causando daño al horno. Usar un bajo voltaje dará como resultado un cocinado más lento. Panasonic no se hace responsable por daños resultantes del uso del horno con otros voltajes que no sea el especificado.
3. El horno debe ser conectado en un enchufe a tierra de al menos 20 amp 120 volt, 60 Hz. Donde se encuentre un enchufe estándar de 2 entradas es responsabilidad y obligación del consumidor reemplazarlo por un enchufe a tierra de 3 entradas.
4. Una conexión temporal con un adaptador de 2 entradas puede ser hecha donde los CODIGOS LOCALES LO PERMITAN. A menos que el tornillo de la cubierta del enchufe esté conectado a tierra mediante el cableado de la casa, atornillar el adaptador a la tapa del enchufe **NO** pondrá a tierra el horno. Si hay alguna duda de si el tornillo de la tapa del enchufe está a tierra haga que lo cheque en electricista.

# Sugerencias Útiles

## Siga Esta Precauciones de Seguridad Cuando Cocine en Su Horno

### 1) ENLATADO CASERO/ALIMENTOS DESHIDRATADOS/PEQUEÑAS CANTIDADES DE ALIMENTOS

- No use su horno para el enlatado casero o para calentar cualquier frasco cerrado. La presión aumentará y el frasco puede explotar. Su horno no puede mantener los alimentos a la temperatura apropiada de enlatado.
- Pequeñas cantidades de alimento o alimentos con bajo contenido de humedad se pueden secar, quemar o incendiarse.
- No seque alimentos, hierbas, frutas o vegetales en su horno.

#### IMPORTANTE

La cocción adecuada depende del tiempo designado y del peso de los alimentos. Si usa una porción menor de la recomendada y cocina por el tiempo para la porción recomendada, puede resultar un incendio. Si ocurre un incendio, ponga el horno en posición de apagado y manténgalo cerrado. Desconecte la energía eléctrica o desconecte la caja de fusibles o el panel de control.

### 2) PALOMITAS DE MAÍZ

Las palomitas de maíz deben prepararse en un recipiente para palomitas de maíz adecuado para horno de microondas. Palomitas de maíz para horno de microondas que se preparan en su propio paquete también están disponibles. Siga las instrucciones del fabricante de palomitas de maíz y use una marca adecuada para la potencia de su horno de microondas. Nunca deje desatendido el horno cuando prepare palomitas de maíz.

#### PRECAUCIÓN

Cuando use palomitas de maíz para microondas previamente empacado siga las instrucciones recomendadas en el paquete. Revise el peso del paquete antes de usar la tecla de palomitas de maíz. Prepare el horno para el peso del paquete de palomitas de maíz (vea página 21). Si no se siguen estas instrucciones, las palomitas de maíz pueden no reventar adecuadamente o pueden encenderse y causar un incendio.

### 3) FREIR CON MUCHA GRASA

- No trate de freír con mucha grasa en su horno de microondas. Cocinar aceites puede estallar en flamas y puede causar daño al horno y quizá acabar en quemaduras. Los utensillos de microondas pueden no ser útiles para soportar la temperatura del aceite caliente, y podrían romperse.

### 4) HUEVOS

- No caliente huevos en su cáscara en el horno de microondas. La presión subirá y el huevo explotará.

### 5) ALIMENTOS CON PIELS NO POROSAS

- Papas, manzanas, yemas de huevo, calabazas completas y salchichas son ejemplos de alimentos con pieles no porosas. Estos tipos de alimentos deben ser perforados antes de cocinarlos en Microondas para evitar que estallen.

- Use papas frescas para hornear y cocinelas hasta que estén listas. Cocinar demasiado causa deshidratación y puede producir un incendio. Use los pesos recomendados o puede ocurrir un incendio.

### 6) LIQUIDOS

- Los líquidos calientes pueden hacer erupción si no se mezclan con el aire. No caliente líquidos en su horno de microondas sin agitarlos antes.

### 7) BANDEJA DE CRISTAL/UTENSILIOS DE COCINA/PAPEL ALUMINIO

- Los utensillos para cocinar se calientan durante la cocción en microondas. Use soportes para lo caliente, cuando saque los utensillos del horno o cuando quite tapas o cubiertas de envoltura de plástico de los utensillos de cocina, para evitar quemaduras.
- La bandeja de cristal se calentará durante la cocción. Debe permitirse que se enfríe antes de manejarla o antes de colocar productos de papel, tales como platos de papel o bolsas de palomitas de maíz para microondas, para cocinar.

- Cuando se use papel aluminio, brochetas, rejillas para calentar o utensillos hechos de metal en el horno, deje por lo menos 2,5 cm de espacio entre el material de metal y las paredes interiores del horno. Si arquea (chispea) quite el material de metal (brochetas etc.) y/o cambíelo a un contenedor no metálico.

- Platos con adornos metálicos no deberan ser usados, ya que puede producirse arco eléctrico.

### 8) TOALLAS DE PAPEL/TELAS

- No use toallas de papel o telas que contengan fibras sintéticas en su tejido. La fibra sintética puede causar que la toalla se incendie.

- No use bolsas de papel o productos de papel reciclado en el horno de microondas.

### 9) BANDEJA DORADORA/BOLSAS PARA COCINAR EN HORNO

- Los bandeja doradora o asados son diseñados para cocinar en microondas solamente. Siempre siga las instrucciones dadas por el fabricante. No precaliente la bandeja doradora mas de 8 minutos.

- Si se usa una bolsa para cocinar para el microondas, prepare de acuerdo a las instrucciones del paquete. No use sujetadores de alambre para cerrar la bolsa.

### 10) TERMÓMETROS

- No use termómetros convencionales para alimentos en su horno. Puede producir arco.

### 11) GUÍA DE USO GENERAL DEL HORNO/PUERTA DEL HORNO

- No use el horno por cualquier razón que no sea la preparación de alimentos.

- No deje sin atención el horno mientras esté en uso.

## Diagrama de Características

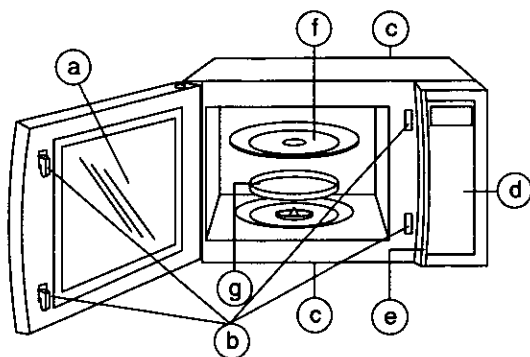

- (a) Ventana del horno  
(on barrera de vapor - no removerse)
- (b) Sistema de seguridad de la puerta
- (c) Orificios de ventilación del horno
- (d) Panel de control
- (e) Placa de identificación
- (f) Bandeja de cristal
- (g) Anillo del rodillo

## Panel de Control

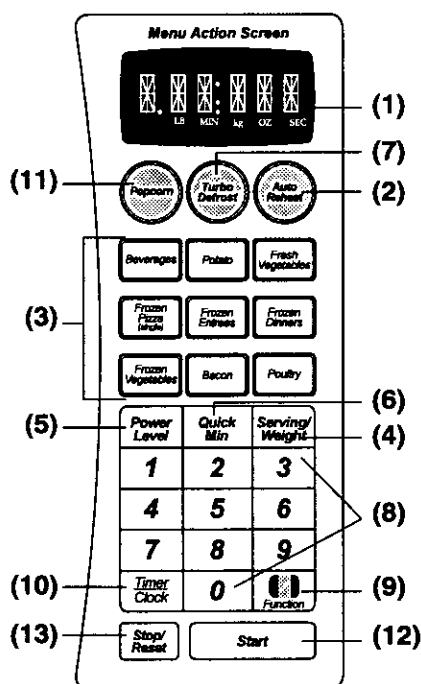

- (1) Pantalla indicadora
- (2) Pulsador de recalentamiento automático
- (3) Pulsador de auto cocción
- (4) Pulsador de porción / peso
- (5) Pulsador de potencia
- (6) Pulsador de rapido en minutos
- (7) Pulsador de descongelamiento rapido
- (8) Pulsador de numéricos
- (9) Pulsador de funciones
- (10) Pulsador de tiempo de espera
- (11) Pulsador de palomitas de maíz
- (12) Pulsador Para Comenzar
- (13) Pulsador Para/Cancelar

# Funciones



Los pulsadores le permiten escoger el sistema en cada característica.



<b>1</b>	<p><b>OPCIÓN DE IDIOMA</b></p> <p>La pantalla de el horno viene en inglés, francés y español. La pantalla aparece en inglés cuando usted conecta el horno.</p> <p>1 ENGLISH → La pantalla aparece en inglés.                  2 FRANÇAIS → La pantalla aparece en francés.                  3 ESPANOL → La pantalla aparece en español.</p>
<b>2</b>	<p><b>OPCIÓN Lb/Kg.</b></p> <p>El horno tiene medidas de peso métricas e imperiales. El horno estará en la medida de peso imperial cuando lo conecte.</p> <p>1 Lb. → El peso puede ser puesto en oz/lb.                  2 KG → El peso puede ser puesto en kg/g.</p>
<b>3</b>	<p><b>VELOCIDAD DE PALABRA</b></p> <p>La velocidad de las palabras en la pantalla puede correr más rápido o más lento.</p> <p>1 RÁPIDO → Las palabras correrán rápido.                  2 MEDIO → Las palabras correrán a su velocidad inicial.                  3 LENTO → Las palabras correrán lento.</p>
<b>4</b>	<p><b>ACCIÓN DEL MENÚ ENCENDIDO/APAGADO</b></p> <p>La acción del menú en pantalla le ayuda a programar el horno indicando el siguiente paso a fumar por anticipado. Cuando usted se familiarize con su horno, esto puede ser apagado.</p> <p>1 ENCENDIDO (On) → La guía aparecerá.                  2 APAGADO (Off) → La guía no aparecerá.</p>
<b>5</b>	<p><b>SEGURO PARA NIÑOS ENCENDIDO/APAGADO</b></p> <p>El horno tiene la característica de seguro para niños para prevenir su uso por niños.</p> <p>1 ENCENDIDO (On) → El seguro ha sido puesto y ninguna operación será aceptada.                  2 APAGADO (Off) → El seguro ha sido cancelado.</p>
<b>6</b>	<p><b>SONIDO "BEEP" ENCENDIDO/APAGADO</b></p> <p>Si ustedes desea que el horno opere sin sonido "beep", puede ser eliminado.</p> <p>1 ENCENDIDO (On) → El sonido "beep" reaparecerá.                  2 APAGADO (Off) → El sonido "beep" no se escuchará.</p>
<b>7</b>	<p><b>SONIDO "BEEP" DE RECORDATORIO ENCENDIDO/APAGADO</b></p> <p>Este sonido "beep" es para recordar le que retire el alimento después de que se ha completado la cocción.</p> <p>1 ENCENDIDO (On) → El sonido "beep" de recordatorio trabajará.                  2 APAGADO (Off) → El sonido "beep" de recordatorio no trabajará.</p>
<b>8</b>	<p><b>HORARIO DE VERANO</b></p> <p>1 ENCENDIDO (On) → Automáticamente ajusta el reloj una hora hacia adelante.                  2 APAGADO (Off) → Retrasa el reloj a su hora original.</p>
<b>9</b>	<p><b>RELOJ ENCENDIDO/APAGADO</b></p> <p>El reloj puede apagarse.</p> <p>1 ENCENDIDO (On) → El reloj reaparecerá.                  2 APAGADO (Off) → El reloj desaparece.                  La hora del día no se perderá si el reloj desaparece de la pantalla.</p>
<b>0</b>	<p><b>MODO DE DEMOSTRACIÓN ENCENDIDO/APAGADO</b></p> <p>El modo de demostración está diseñado para su exhibición en tienda. En esta modo, el horno puede ser demostrado sin poder o potencia.</p> <p>1 ENCENDIDO (On) → El horno estará en modo de demostración.                  2 APAGADO (On) → El horno no estará en modo de demostración.</p>

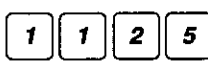

## Para Ajustar el Reloj

Ejem.: Para fijar 11:25 a.m. o p.m.

1.		<ul style="list-style-type: none"> <li>Presione el pulsador.</li> <li>►Timer/Clock dos veces.</li> </ul>
2.		<ul style="list-style-type: none"> <li>Fije la hora correcta del día.</li> <li>►Los dos puntos parpadearán.</li> </ul>
3.		<ul style="list-style-type: none"> <li>Presione el pulsador.</li> <li>Timer/Clock 1 vez.</li> <li>►Los dos puntos dejarán de parpadear. La hora está ingresada y ubicada en la pantalla indicadora.</li> </ul>

## Pulsador de Palomitas de Maíz

Ejem.: Para recalentar 99 g (3.5 oz.) de palomitas de maíz en bolsas especiales para microondas



1.	 1 vez	<ul style="list-style-type: none"> <li>Seleccione el peso que se indica en la bolsa de palomitas.</li> </ul> <table border="1" data-bbox="359 1123 646 1260"> <thead> <tr> <th>Presionar</th> <th>Peso</th> </tr> </thead> <tbody> <tr> <td>1 vez</td> <td>99 g (3.5 oz.)</td> </tr> <tr> <td>2 veces</td> <td>90 g (3.0 oz.)</td> </tr> <tr> <td>3 veces</td> <td>50 g (1.75 oz.)</td> </tr> </tbody> </table>	Presionar	Peso	1 vez	99 g (3.5 oz.)	2 veces	90 g (3.0 oz.)	3 veces	50 g (1.75 oz.)
Presionar	Peso									
1 vez	99 g (3.5 oz.)									
2 veces	90 g (3.0 oz.)									
3 veces	50 g (1.75 oz.)									
2.		<ul style="list-style-type: none"> <li>Presione.</li> <li>►El tiempo de cocinado aparece y empieza la cuenta regresiva.</li> </ul>								

### NOTA:

Ponga la bolsa en el interior del horno de acuerdo con las instrucciones del fabricante.

## Para seleccionar la Potencia y Tiempo

Ejem.: Nivel de potencia MEDIA por 5 minutos

1.	 4 veces	<ul style="list-style-type: none"> <li>Seleccione el nivel de potencia.</li> </ul>
2.		<ul style="list-style-type: none"> <li>Seleccione el tiempo de cocción (hasta 99 minutos y 99 segundos).</li> </ul>
3.		<ul style="list-style-type: none"> <li>Presione el pulsador <b>Start</b>.</li> </ul>



### Notas:

- Al seleccionar el nivel de potencia ALTO en la primera etapa, no es necesario presionar el pulsador **Power Level**. Simplemente fije el tiempo de cocción presionado los pulsadores de Tiempo y **Start**.
- Para cocción en 2 o 3 etapas, repetir los pasos arriba citados, antes de apretar el pulsador **Start**.
- Pulsador **Power Level**.

Pulse	Nivel de Potencia	%Potencia
1 vez	HI (Alto)	100%
2 veces	DEF (Descongelación)	30%
3 veces	MED HI (Medio-alto)	70%
4 veces	MED (Medio)	55%
5 veces	MED LO (Medio-bajo)	30%
6 veces	LO (Bajo)	10%

## Descongelamiento Rápido

Ejem.: Para descongelar .7 kg (1 lb. 8 oz.) de carne

1.		• Establezca el peso de el alimento. El peso debe ser programado en libras.
2.		• Se usted desea usar lb, vea la página 9 "Conversión."
3.		• Presione el pulsador de <b>Start</b> .

### NOTA:



La forma y el tamaño de los alimentos determinará el peso máximo que el horno puede acomodar. El peso máximo para carnes es de 1.8 kg (4 lb), aves 2.7 kg (6 lb) y pescados y mariscos 1.4 kg (3 lb).

## Función Rápido en Minutos

Esta característica le permite ajustar el tiempo de cocción fácilmente en vez de usar los pulsadores numéricos o agregar tiempo de cocción extra.

### Para seleccionar el tiempo de cocción:

Ejem.: Nivel de potencia ALTO por 1 minuto

1.	 1 vez	• Seleccione el tiempo de cocción (hasta 10 min).
2.		• Presione el pulsador de <b>Start</b> .

### NOTA:

- Se puede usar otro nivel de potencia, selecciónelos antes de ajustar el tiempo.
- Después de haber ajustado el tiempo por medio del pulsador **Quick Min** no podrá usar los pulsadores numéricos o vice versa.

### Para Agregar Tiempo Extra:



	• Oprima para agregar tiempo de cocción (hasta 10 min) durante el cocinado. ►El tiempo de cocinado cambia para incluir el tiempo extra y continúa la cuenta regresiva en la pantalla.
---	--

### NOTA:

Usted puede añadir tiempo de cocción para todos los platillos con las funciones de poder y tiempo.

## Recalentamiento Automático

Ejem.: Recalentar 1 taza de sopa.

1.	 1 vez	• Presione el pulsador de <b>Auto Reheat</b> hasta que el numero de servicios deseado aparezca en la pantalla.
2.		• Presione el pulsador de <b>Start</b> .

**NOTA:** La lista de abajo son los alimentos y peso recomendados.

Alimentos	Número de servicios	Tamaño del servicio	Temperatura de inicio
Plato de alimentos	1 - 4	12 - 16 oz. (340 g)	Refrig.
Carnes/Aves	1 - 4	4 - 6 oz. (340 g)	Refrig.
Guisados.	1 - 2	8 oz. (220 g)	Refrig.
Guarniciones	1 - 4	4 - 5 oz.	Refrig. o Temp. Ambiente
Sopas/Salsas/Gravy	1 - 2	6 - 8 oz.	Refrig. o Temp. Ambiente





# Auto Cocción

## Utilizando los programas de autococción

Estos son probados y con tiempos pre-establecidos (basados en el poder de este horno) para la cantidad de comida enlistada en la tabla de abajo. Las fluctuaciones de potencia y los gustos personales no han sido tomados en cuenta localmente. Si usted prefiere la comida cocinada en forma diferente, utilice la potencia y el tiempo con los métodos que se muestran en la página 21.

## PARA UTILIZAR LA AUTOCOCCIÓN

 <b>(Vegetales)</b>	1) Seleccione la categoría de comida deseada (ver tabla abajo)
 <b>(Porciones/Peso)</b>	2) Presione el pulsador de porciones/peso hasta que la cantidad deseada aparezca en la pantalla.
 <b>(Inicio)</b>	3) Presione el pulsador de <b>Start</b> . El tiempo de cocción aparecerá en la pantalla y contará.



## CODIGOS DE AUTO COCCIÓN

PULSADOR	CATEGORIA	PORCION / PESO	INDICACIONES
BEBIDA	CAFÉ / TE	1 ou 2 TAZAS	NO caliente líquidos en su Horno de Microondas sin antes agitar. Los líquidos calientes pueden ebulle si no se mezclan con aire.
	SOPA	1-2 PORCIONES	Utilice sopas a base de agua.
PAPAS		1-4 PAPAS(6-8 oz)	Perfore la cascara con un tenedor, acomode en círculo.
VEGETALES FRECOS		4, 8, 12, 16 oz (110,225,340,450 g) Para mejores resulta dos todas las piezas deben ser del mismo tamaño.	Cubra con tapa o papel autoadherente. Agregue un poco de agua. Revuelva ocasionalmente durante la cocción. Deje reposar, cubierto de 3-5 minutos antes de servir.
PIZZA CONGELADAS		4, 8 oz (110, 225 g)	Siga las instrucciones del paquete o ponga la pizza en un recipiente especial.
ENTRADAS CONGELADAS		8, 10, 20, 32 oz (225,300,600,900 g)	Siga las instrucciones del paquete para cubrir o remover las cubiertas. Para mejores resultados no utilice comida congelada empacada en recipientes de aluminio. A la mitad de la cocción, reacomode o agite.
PLATOS FUERTES CONGELADAS		11, 15 oz (300, 430 g)	
VEGETALES CONGELADAS		5, 10, 16 oz (150,300,450 g)	Siga las instrucciones del paquete o ponga en un plato, agregue agua y cubra (on papel autoadherente).
TOCINO		2,3,4,6 rebanadas	Coloque las rebanadas en un recipiente para hornos de microondas y cubra con toallas de papel.
AVES	PIEZAS DE POLLO	6, 12, 18, 24 oz (170,340,500,680 g)	Coloque las piezas con la piel para arriba. Cubra con papel autoadherible.
	POLLO ENTERIO	3.5, 4.0, 5.0, 5.5 lb (1.5, 1.8, 2.2, 2.5 kg)	Coloque la pechuga para abajo. Cubra con papel autoadherible. Coloque la pechuga para arriba a la mitad de la cocción.

# Temporizador (Timer)





## Para usar como temporizador en la cocina:

Ejem.: Para contar 5 minutos

1.		• Presione el pulsador <b>Timer</b> una vez.
2.		• Indique la cantidad de tiempo (hasta 99 min y 99 segundos).
3.		• Presione el pulsador <b>Start</b> . ► El tiempo comenzará a contar en forma descendente sin que el horno esté funcionando.





## Para fijar un tiempo de espera o tiempo de reposo:

Ejem.: Después de la cocción dejar reposar el alimento durante 5 minutos.

1.	Ej.  ↓ 	• Seleccione el programa de cocción (ver p.21 para instrucciones).
2.		• Presione el pulsador de <b>Timer</b> una vez.
3.		• Indique la cantidad de tiempo (hasta 99 min y 99 segundos).
4.		• Presione el pulsador de <b>Start</b> . ► Después de la cocción el tiempo de reposo empezará a contar en forma descendente sin que el horno esté funcionando.

## Para programar un comienzo tardío:

Ejem.: Para empezar a cocinar 5 minutos después

1.		• Presione el pulsador <b>Timer</b> una vez.
2.		• Indique la cantidad de tiempo que tardará en empezar el programa (hasta 99 min y 99 seg).
3.	Ej.  ↓ 	• Seleccione el programa de cocción (ver p.21 para instrucciones).
4.		• Presione el pulsador de <b>Start</b> . ► Cuando el tiempo demorado comience la cuenta regresiva y este haya finalizado, la cocción iniciará.

### Notas:

1. Si la puerta del horno es abierta durante el tiempo de espera o cuando se usa como temporizador, el tiempo que se indica en la ventanilla continuará contando en forma regresiva.
2. El comienzo tardío no puede ser programado antes de ninguna función automática.  
Esto es para prevenir que el inicio de la temperatura de los alimentos se incremente antes del descongelamiento o inicio de la cocción.  
Un cambio en el inicio de la temperatura podría causar resultados inadecuados.

# Cuidados de Su Horno de Microondas

**ANTES DE LIMPIAR:** Apague el horno y desconecte el cable de alimentación para prevenir un encendido accidental.

**Interior del horno:** Limpie su horno con un paño húmedo. Puede utilizar un detergente suave si el horno esta muy sucio. El uso de limpiadores abrasivos no es recomendable.

**Puerta del horno:** Si el vapor se acumula en el interior o alrededor de la puerta del horno, limpie con un paño suave. Esto puede suceder cuando el horno se opera en condiciones demasiado húmedas y no indica mal funcionamiento de la unidad.

**Panel de controles:** Limpie su panel con un paño suave, no use detergentes fuertes ni abrasivos.

**Plato giratorio de cristal:** Remueva el plato de cristal. Cuando esté frío y lave con agua tibia y jabonosa o en su lavadora de platos.

**El anillo giratorio:** Limpie el soporte del plato giratorio que se encuentra en el horno con agua jabonosa. El anillo giratorio debe ser limpiado en agua jabonosa o en su lavadora de platos. Estas partes deben estar limpias para evitar un excesivo ruido.

**DESPUES DE LIMPIAR:** Esté seguro de colocar el anillo giratorio y el plato de cristal en la posición correcta y presione **Stop/Reset** para limpiar la pantalla indicadora.

## Antes de Acudir al Servicio

### Todas estas cosas son normales:

Mi horno de microondas causa interferencia con mi televisor.

En algunos radios y televisores puede ocurrir interferencia cuando usted cocine con su horno de micro ondas, Esta interferencia es similar a la interferencia causada por pequeños aparatos eléctricos como batidoras, aspiradoras, secadoras de aire, esto no indica ningún problema.

La luz del horno se atenúa.

Cuando se está cocinado con una temperatura diferente a temperatura alto (HIGH) el horno tiene que recorrer un ciclo para obtener niveles de potencia más bajos. La luz del horno se atenúa y podrá oír ruidos de "click" cuando el horno realiza su ciclo.

Se acumula vapor en la puerta del horno y aire caliente sale de las rejillas de ventilación.

Durante la cocción los alimentos despiden vapor. La mayoría de este vapor es removido por el aire que circula en la cavidad del horno, sin embargo, algo de vapor se condensará en las superficies frías tales como la puerta del horno. Esto es normal.

Accidentalmente encendió su horno de micro ondas sin ningún alimento dentro.

Operar el horno vacío por un corto tiempo no dañará el horno sin embargo no lo recomendamos.

### PROBLEMA

### POSIBLE CAUSA

### SOLUCION

El horno no enciende.



¿Esta el horno conectado en forma segura?

Remueva la clavija de contacto de la toma de corriente. Espere 10 seg. Vuelva a conectar.

El circuito general de luz o el fusible estan fuera de servicio o tienen algún problema interno.

Encienda de nuevo su circuito general de luz o reemplace el fusible.

Hay un problema en la toma de corriente.

Conecte otro aparato eléctrico para verificar su toma de corriente.

El horno no acepta mi programa.



La puerta del horno no está bien cerrada.































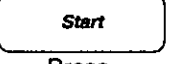





Cierre la puerta firmemente.

Otro programa se encuentra registrado en su horno.

Presione **Stop/Reset** (parar/ borrar) para cancelar el programa anterior y programe de nuevo.

Si al parecer el problema se encuentra en su horno, consulte al centro de servicio más cercano.

# Quick Guide to Operation

Feature	How to Operate
To Set <b>Clock</b> (☛page 8)	 → Enter time of day.  Thru  →  Press twice. Press once.
To Set <b>Power and Time</b> (☛page 8)	 → Set cooking time.  Thru  →  Press to select Power Level. Press.
To Defrost using <b>Turbo Defrost Pad</b> (☛page 10)	 →  Thru  →  Set weight. Press.
To reheat using <b>Auto Reheat Pad</b> (☛page 10)	 →  Select serving (1-4). Press.
To use <b>Quick Min Pad</b> (☛page 8)	 →  (up to 10 min.) Press.
To Cook using <b>Popcorn Pad</b> (☛page 8)	 →  Select weight. Press.
To Cook using <b>Auto Cook Pads</b> (☛page 9)	Select category. e.g.  →  →  Press.
To Use as a <b>Kitchen Timer</b> (☛page 12)	 →  THRU  →  Press once.
To Set <b>Stand Time</b> (☛page 12)	(Input up to 2 cooking programs.) →  →  THRU  →  Press once. Press.
To Set <b>Delay Start</b> (☛page 12)	 →  THRU  → (Input up to 2 cooking programs.) →  Press once. Press.
To Use <b>Function Pad</b> (☛pages 6-7)	 →  THRU  → Select Option 1, 2 or 3 Press.