

# HP Color LaserJet 2605, 2605dn, 2605dtn User Guide

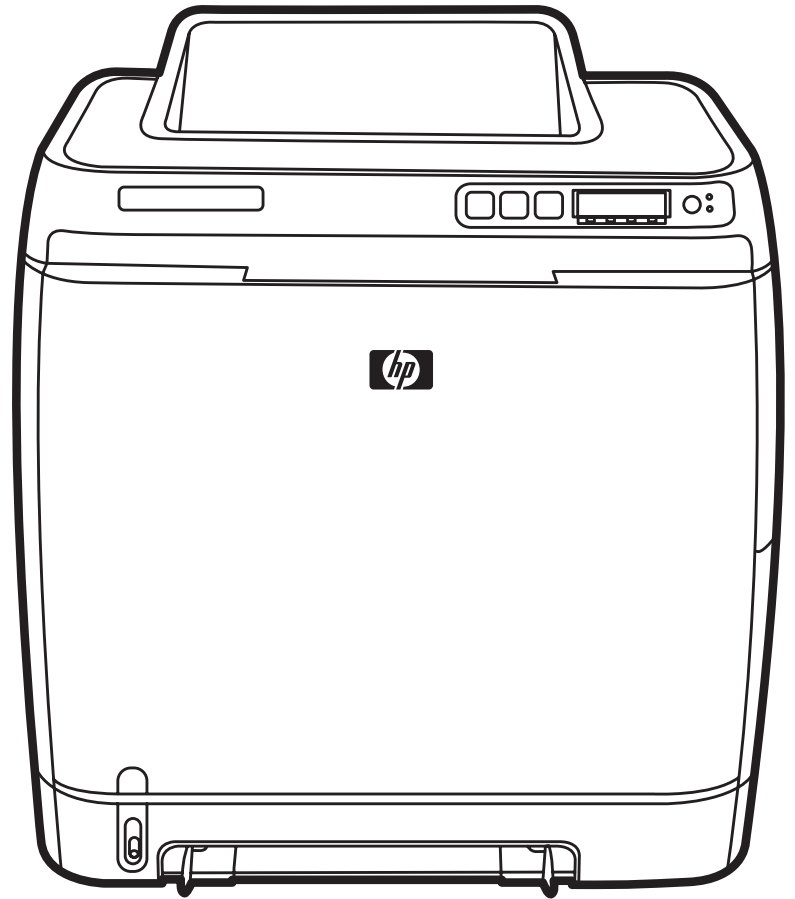



# HP Color LaserJet 2605, 2605dn, and 2605dtn Printer

---

User Guide



## Copyright and License

© 2006 Copyright Hewlett-Packard Development Company, L.P.

Reproduction, adaptation, or translation without prior written permission is prohibited, except as allowed under the copyright laws.

The information contained in this document is subject to change without notice.

The only warranties for HP products and services are set forth in the express warranty statements accompanying such products and services. Nothing herein should be construed as constituting an additional warranty. HP shall not be liable for technical or editorial errors or omissions contained herein.

Part number Q7821-90906

Edition 1, 4/2006

## Trademark Credits

Adobe Photoshop® and PostScript are trademarks of Adobe Systems Incorporated.

CorelDRAW™ is a trademark or registered trademark of Corel Corporation or Corel Corporation Limited.

Microsoft®, Windows®, MS-DOS®, and Windows NT® are U.S. registered trademarks of Microsoft Corporation.

Netscape™ and Netscape Navigator™ are U.S. trademarks of Netscape Communications Corporation.

TrueType™ is a U.S. trademark of Apple Computer, Inc.

UNIX® is a registered trademark of The Open Group.

ENERGY STAR® and the ENERGY STAR logo® are U.S. registered marks of the United States Environmental Protection Agency. Details on the proper use of the marks are explained in the "Guidelines for Proper use of the ENERGY STAR® Name and International Logo."



# Table of contents

## 1 Printer basics

Quick access to printer information .....	2
Printer configurations .....	3
HP Color LaserJet 2605 printer .....	3
HP Color LaserJet 2605dn printer .....	3
HP Color LaserJet 2605dtn printer .....	4
Printer features .....	5
Walk around .....	7
Software .....	9
Software and supported operating systems .....	9
Software tips .....	9
How do I gain access to the printer features? .....	9
How do I get the latest printing software? .....	10
What other software is available? .....	10
Print-media specifications .....	11
General guidelines .....	11
Paper and print media .....	11
Printing and storage environment .....	12
Envelopes .....	12
Labels .....	14
Transparencies .....	15
HP LaserJet glossy paper and HP LaserJet Photo paper .....	15
Letterhead or preprinted forms .....	15
HP LaserJet Tough paper .....	15
Custom-sized print media or cardstock .....	16
Supported media weights and sizes .....	16

## 2 Software for Windows

Printer drivers .....	20
Using Help .....	20
HP ToolboxFX .....	21
Embedded Web server (EWS) .....	22
HP Web Jetadmin .....	23
Uninstalling the printing software .....	24
Uninstalling software for Windows .....	24
Uninstalling software for Windows by using Add or Remove Programs .....	24

## 3 Software for Macintosh

Software for Macintosh computers .....	26
--	----

Installing Macintosh printing system software for networks .....	26
Installing Macintosh printing system software for direct connections (USB) .....	27
To remove software from Macintosh operating systems .....	27
Printer drivers for Macintosh computers .....	28
Supported printer drivers .....	28
Gaining access to the printer drivers .....	28
Using features in the Macintosh printer driver .....	29
Creating and using presets in Mac OS X .....	29
Printing a cover page .....	29
Printing multiple pages on one sheet of paper .....	30
Printing on both sides of the paper .....	30
Setting the color options .....	31
Enabling memory .....	32
Managing printer color options on Macintosh computers .....	33
Print Color as Gray .....	33
Advanced color options for text, graphics, and photographs .....	33
Halftone options .....	33
Neutral Grays .....	33
RGB Color .....	34
Edge Control .....	34
Using Macintosh Configure Device .....	35
Macintosh Configure Device (Mac OS X V10.3 and Mac OS X V10.4) .....	35
Troubleshooting common Macintosh problems .....	36
Solving problems with Mac OS X .....	36

## 4 Control panel

Control panel features .....	40
Display .....	40
Control panel menus .....	41
Using the control panel menus .....	41
Control panel menu map .....	41
Understanding Supplies Status .....	42
Black, Yellow, Cyan, and Magenta Supplies Status gauges .....	43
Understanding Printer Status .....	43
Cancel Job button .....	43
Attention light .....	43
Ready light .....	43
Left and Right arrow buttons .....	43

## 5 Printing tasks

Loading trays .....	46
Loading Tray 1 .....	46
Loading Tray 2 .....	47
Printing on special media .....	52
Controlling print jobs .....	53
Settings for selecting print media .....	53
Features in the printer driver .....	54
Setting a custom paper size .....	54
Printing in grayscale .....	54
Changing the color settings .....	54

Creating and using watermarks .....	54
Printing multiple pages on one sheet of paper (N-up printing) .....	55
Creating and using Quick Sets .....	55
Reducing or enlarging .....	55
Printing on different paper for the first page .....	55
Restoring the default printer-driver settings .....	56
To print from Windows .....	56
Gaining access to printer driver settings .....	56
Printing on both sides .....	58
Canceling a print job .....	60

## 6 Color

Using color .....	62
HP ImageREt 2400 .....	62
Media selection .....	62
Color options .....	62
Standard red-green-blue (sRGB) .....	62
Managing color options .....	64
Print in Grayscale .....	64
Automatic versus Manual color adjustment .....	64
Change color options .....	64
Halftone options .....	65
Edge Control .....	65
RGB Color .....	65
Neutral Grays .....	66
Matching colors .....	67

## 7 Photo

Inserting a memory card .....	70
Changing memory card default settings .....	72
Changing memory card settings for the current job .....	73
Printing photos directly from the memory card .....	74
Printing a memory card index .....	75

## 8 Networking

Set up the printer and use it on the network .....	78
To configure a network port-connected printer configuration (direct mode or peer-to-peer printing) .....	78
To configure a direct-connected shared printer (client server printing) .....	79
To change from a direct-connected shared printer to a network port-connected printer configuration .....	79
Managing the network .....	80
Viewing network settings .....	80
Changing network settings .....	80
Set my network password .....	80
Using the printer control panel .....	81
Network configuration page .....	81
Configuration page .....	81
IP configuration .....	81

Configure a static IP address for my printer .....	81
Automatic configuration .....	82
Link speed and duplex settings .....	82
Supported network protocols .....	84
TCP/IP .....	86
Internet Protocol (IP) .....	86
Transmission Control Protocol (TCP) .....	86
User Datagram Protocol (UDP) .....	86
IP address .....	86
IP address: network portion .....	87
IP address: host portion .....	87
IP address structure and class .....	87
Configuring IP parameters .....	88
Dynamic Host Configuration Protocol (DHCP) .....	88
BOOTP .....	88
Subnets .....	88
Subnet mask .....	88
Gateways .....	89
Default gateway .....	89
TCP/IP configuration .....	89
Server-based, AutoIP, and manual TCP/IP configuration .....	89
Server-based TCP/IP configuration .....	90
Default IP address configuration (AutoIP) .....	90
TCP/IP configuration tools .....	90
Troubleshooting .....	91
Verifying that the printer is on and online .....	91
Resolving communication problems with the network .....	91

## 9 How do I?

Print: How do I? .....	94
Set the printer for high-quality output .....	94
Print on both sides of the paper .....	95
Select paper type for special media .....	97
Change the device print settings, such as print quality, in HP ToolboxFX .....	97
Print color documents from my computer in black and white only .....	98
Change color options .....	98
Halftone options .....	98
Edge Control .....	98
RGB Color .....	99
Neutral Grays .....	99
Network: How do I? .....	100
Set up the printer and use it on the network .....	100
Set my network password .....	100
Find my network IP address .....	100
Configure a static IP address for my printer .....	100
Add memory: How do I? .....	102
Installing memory and font DIMMs .....	102
Other: How do I? .....	105
Changing print cartridges .....	105
To change the print cartridge .....	105



## 10 Managing the printer

Device pages and reports .....	110
Demo page .....	110
Configuration page .....	110
Supplies Status page .....	111
Networking page .....	113
Fonts pages .....	113
Usage page .....	113
Menu map .....	114
HP ToolboxFX .....	115
To view HP ToolboxFX .....	115
Status .....	116
Event log .....	116
Alerts .....	117
Set up status alerts .....	117
Set up e-mail alerts .....	117
Help .....	117
Device settings .....	118
Device information .....	118
Paper handling .....	119
Printing .....	119
PCL5e .....	119
PostScript .....	120
Print quality .....	120
Print density .....	120
Paper types .....	121
Memory card (HP Color LaserJet 2605dtn) .....	121
System setup .....	122
Service .....	122
Network settings .....	122
Using the embedded Web server .....	123
To access the embedded Web server using a network connection .....	123
Information tab .....	124
Settings tab .....	124
Networking tab .....	125
Other links found in HP ToolboxFX .....	125

## 11 Maintenance

Managing supplies .....	128
Supplies life .....	128
Checking and ordering supplies .....	128
To check status and order using the control panel .....	128
To check and order supplies using HP ToolboxFX .....	128
To check and order using HP Web Jetadmin .....	129
Storing supplies .....	129
Replacing and recycling supplies .....	129
HP policy on non-HP supplies .....	129
Resetting the printer for non-HP supplies .....	129
HP anti-counterfeit website .....	130
Cleaning the printer .....	131

To remove toner build-up .....	131
To clean the paper path using HP ToolboxFX .....	133
Cartridge out override .....	134
Configuration .....	134
On-going operation .....	134
Changing print cartridges .....	135
To change the print cartridge .....	135
Calibrating the printer .....	138
To calibrate the printer at the printer .....	138
To calibrate the printer from the HP ToolboxFX .....	138

## 12 Problem solving

Troubleshooting process .....	140
Troubleshooting checklist .....	140
Control panel messages .....	142
Alert and warning messages .....	142
Critical error messages .....	145
Clearing jams .....	148
Where to look for jams .....	148
To clear jams from inside the printer .....	149
To clear jams from the duplex area (HP Color LaserJet 2605dn and 2605dtn models only) .....	150
To clear jams from the top bin (HP Color LaserJet 2605) .....	152
To clear jams from the top output area (HP Color LaserJet 2605dn and 2605dtn models only) .....	153
To clear jams from Tray 2 or optional Tray 3 .....	155
Print problems .....	156
Print quality problems .....	156
Identifying and correcting print defects .....	156
Print-quality checklist .....	156
General print quality issues .....	156
Solving issues with color documents .....	161
Media-handling problems .....	162
Print-media guidelines .....	162
Solving print-media problems .....	163
Performance problems .....	164
Troubleshooting tools .....	165
Device pages and reports .....	165
Demo page .....	165
Configuration page .....	165
Supplies Status page .....	165
HP ToolboxFX .....	165
To view HP ToolboxFX .....	165
Troubleshooting tab .....	165
Service menu .....	166
Restoring the factory-set defaults .....	166
Cleaning the paper path .....	166
Calibrating the printer .....	166

## 13 Working with memory

Printer memory .....	168
Installing memory and font DIMMs .....	169
Checking DIMM installation .....	172
Enabling memory .....	173
Enabling the language-font DIMM for Windows .....	174

## Appendix A Accessories and ordering information

Supplies .....	176
Memory .....	177
Cable and interface accessories .....	178
Paper handling accessories .....	179
Paper and other print media .....	180
User-replaceable parts .....	182
Supplementary Documentation .....	183

## Appendix B Service and support

Hewlett-Packard limited warranty statement .....	186
Print Cartridge Limited Warranty Statement .....	187
HP Customer Care .....	188
Availability of support and service .....	190
HP Care Pack™ Services and Service Agreements .....	190
Repacking the printer .....	191
To repack the printer .....	191
Service information form .....	192

## Appendix C Specifications

Printer specifications .....	194
------------------------------	-----

## Appendix D Regulatory information

Introduction .....	198
FCC regulations .....	199
Environmental Product Stewardship program .....	200
Protecting the environment .....	200
Ozone production .....	200
Power consumption .....	200
HP LaserJet printing supplies .....	200
Disposal of waste equipment by users in private households in the European Union ....	201
Material safety data sheet .....	202
Declaration of conformity .....	203
Country/region-specific safety statements .....	204
Laser safety statement .....	204
Canadian DOC statement .....	204
Korean EMI statement .....	204
VCCI statement (Japan) .....	204
Finnish laser statement .....	205

Index.....	207
------------	-----



# 1 Printer basics

This section provides information about the following topics:

- [Quick access to printer information](#)
- [Printer configurations](#)
- [Printer features](#)
- [Walk around](#)
- [Software](#)
- [Print-media specifications](#)

## Quick access to printer information

Several references are available for use with this printer.

<b>Guide</b>	<b>Description</b>
<i>Getting Started Guide</i>	Provides step-by-step instructions for installing and setting up the printer.
Accessory and consumable Installation guides	Provides step-by-step instructions for installing the accessories and supplies. (These guides are supplied with the optional printer accessories and supplies.)
User guide	Provides detailed information for using and troubleshooting the printer. Available on the printer CD.
Help	Provides information about the options that are available in the printer drivers. To view a Help file, open the online Help through the printer driver.
Readme	Provides detailed information for installing the printer. Available on the printer CD.

## Printer configurations

Thank you for purchasing the HP Color LaserJet 2605 printer. This printer is available in the configuration described below.

### HP Color LaserJet 2605 printer

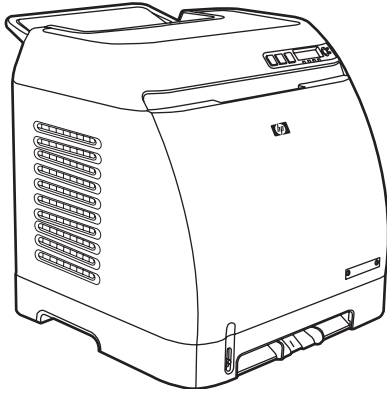

The HP Color LaserJet 2605 printer is a four-color laser printer that prints 10 pages per minute (ppm) in color and 12 ppm in monochrome (black and white).

- **Trays.** The printer comes with a single sheet priority feed slot (Tray 1) and a universal tray (Tray 2) that holds up to 250 sheets of various paper types and sizes or 10 envelopes. It supports an optional 250-sheet paper tray (optional Tray 3). See [Supported media weights and sizes](#) for more information.
- **Connectivity.** The printer provides a Hi-Speed USB 2.0 port for connectivity.
- **Memory.** The printer contains 64 megabytes (MB) of synchronous dynamic random access memory (SDRAM). To allow for memory expansion, the printer has one DIMM slot that accepts 256 MB RAM. This printer can support up to 320 MB of memory.

### HP Color LaserJet 2605dn printer

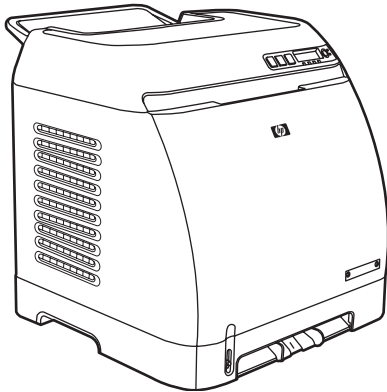

The HP Color LaserJet 2605dn printer is a four-color laser printer that prints 10 ppm in color and 12 ppm in monochrome (black and white).

- **Trays.** The printer comes with a single sheet priority feed slot (Tray 1) and a universal tray (Tray 2) that holds up to 250 sheets of various paper types and sizes or 10 envelopes. It supports an optional 250-sheet paper tray (optional Tray 3). See [Supported media weights and sizes](#) for more information.
- **Connectivity.** The printer provides a USB port for connectivity and an HP built-in internal print server for connecting to a 10/100Base-T network.
- **Memory.** The printer contains 64 megabytes (MB) of synchronous dynamic random access memory (SDRAM). To allow for memory expansion, the printer has one DIMM slot that accepts 256 MB RAM. This printer can support up to 320 MB of memory.
- **Print on Both Sides.** The printer can automatically print on both sides.

## HP Color LaserJet 2605dtn printer

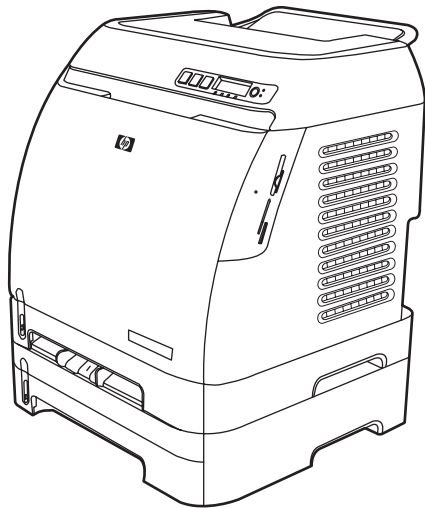

The HP Color LaserJet 2605dtn printer includes the features of the HP Color LaserJet 2605dn printer, but has an additional 250-sheet paper tray (Tray 3) and four memory card slots.



# Printer features

Feature	HP Color LaserJet 2605 series printer
<b>Color printing</b>	<ul style="list-style-type: none"> <li>Provides laser printing in full color by using the four process colors: cyan, magenta, yellow, and black (CMYK).</li> </ul>
<b>Fast print speed</b>	<ul style="list-style-type: none"> <li>Prints in black on A4/letter paper up to 12 ppm. Prints in color on A4/letter at 10 ppm.</li> </ul>
<b>Excellent print quality</b>	<ul style="list-style-type: none"> <li>ImageREt 2400 provides 2400 dpi equivalent-color quality through a multilevel printing process.</li> <li>True 600 by 600 dots per inch (dpi) text and graphics.</li> <li>Adjustable settings to optimize print quality.</li> <li>The HP UltraPrecise print cartridge has a finer toner formulation that provides sharper text and graphics.</li> </ul>
<b>Ease of use</b>	<ul style="list-style-type: none"> <li>Few supplies to order. Supplies are easy to install.</li> <li>Convenient access to printer information and settings by using the HP ToolboxFX software.</li> <li>Convenient access to all supplies and to the paper path through the front door.</li> </ul>
<b>Flexible paper handling</b>	<ul style="list-style-type: none"> <li>Trays 1 and 2 for letterhead, envelopes, labels, transparencies, custom-sized media, postcards, HP LaserJet glossy paper, HP LaserJet Tough paper, heavy paper, and HP Laser Photo paper.</li> <li>A 125-sheet top output bin.</li> <li>Print on Both Sides (manually). See <a href="#">Printing on both sides</a>.</li> <li>Print on Both Sides (Automatically) (HP Color LaserJet 2605dn and HP Color LaserJet 2605dtn models only). See <a href="#">To print on both sides (automatically) (HP Color LaserJet 2605dn and 2605dtn)</a>.</li> </ul>
<b>PostScript® (PS) level 3 emulation language and fonts</b>	Includes 35 built-in PS language fonts.
<b>Interface connections</b>	<ul style="list-style-type: none"> <li>Hi-Speed USB port.</li> <li>The HP Color LaserJet 2605dn and 2605dtn printers includes an HP built-in internal print server for connecting to a 10/100Base-T network.</li> </ul>
<b>Energy savings</b>	<ul style="list-style-type: none"> <li>The printer automatically conserves electricity by substantially reducing power consumption when it is not printing.</li> <li>As an ENERGY STAR® partner, Hewlett-Packard Company has determined that this product meets ENERGY STAR® guidelines for energy efficiency. ENERGY STAR® is a U.S. registered service mark of the United States Environmental Protection Agency.</li> </ul>
<b>Economical printing</b>	<ul style="list-style-type: none"> <li>N-up printing (printing more than one page on a sheet) and Printing on Both Sides features save paper. See <a href="#">Printing multiple pages on one sheet of paper (N-up printing)</a> and <a href="#">Printing on both sides</a>.</li> </ul>

Feature	HP Color LaserJet 2605 series printer
<b>Supplies</b>	<ul style="list-style-type: none"> <li>● A Supplies Status page with print cartridge gauges that show the supply levels that remain. For HP supplies only.</li> <li>● No-shake cartridge design.</li> <li>● Authentication for HP print cartridges.</li> <li>● Enabled supplies-ordering capability.</li> </ul>
<b>Accessibility</b>	<ul style="list-style-type: none"> <li>● Online user guide that is compatible with text screen-readers.</li> <li>● All doors and covers can be opened by using one hand.</li> </ul>
<b>Expandability</b>	<ul style="list-style-type: none"> <li>● Optional Tray 3 (standard on HP Color LaserJet 2605dtn). This 250-sheet universal tray reduces how often you have to add paper to the printer. Only one additional 250-sheet tray can be installed on the printer.</li> <li>● Optional HP Jetdirect external print server for connecting to a network.</li> <li>● One DIMM slot for adding memory and fonts.</li> </ul>
<b>Memory card slots</b> (HP Color LaserJet 2605dtn only)	<p>The following memory cards are supported:</p> <ul style="list-style-type: none"> <li>● CompactFlash</li> <li>● Memory Stick and Memory Stick PRO</li> <li>● MultiMedia</li> <li>● Secure Digital (SD)</li> <li>● SmartMedia</li> <li>● xD</li> </ul>

## Walk around

The following illustrations identify the locations and names of key components of this printer.

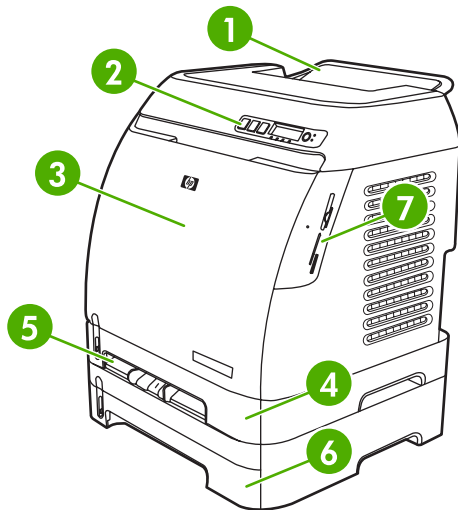

**Figure 1-1** Front view (HP Color LaserJet 2605dtn shown)

1	Output bin
2	Printer control panel
3	Front door
4	Tray 2 (250 sheets)
5	Tray 1 (single sheet priority feed slot)
6	Tray 3 (optional; 250 sheets)
7	Memory card slots (HP Color LaserJet 2605dtn only)

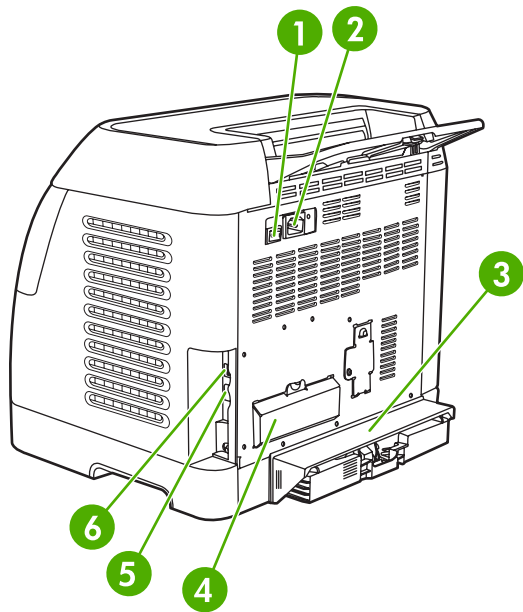

**Figure 1-2** Back and side view

1	On/off switch
2	Power connection
3	Dust cover
4	DIMM access door
5	HP built-in internal print server for connecting to a 10/100 Base-T network (HP Color LaserJet 2605dn and 2605dtn)
6	USB connection

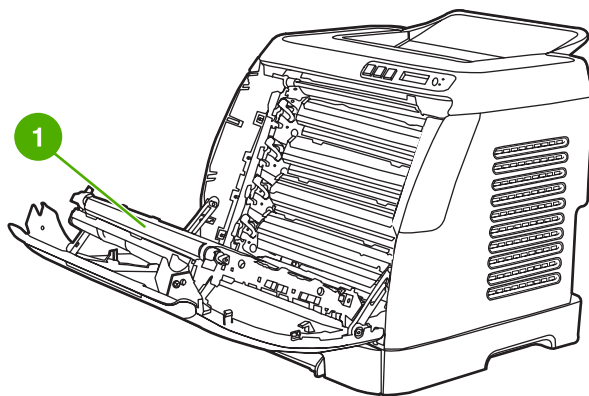

1	Transfer belt (ETB)
---	---------------------



**CAUTION** Do not place anything on the transfer belt, which is located on the inside of the front door. Otherwise, the printer may be damaged, adversely affecting print quality.

# Software

## Software and supported operating systems

For easy printer setup and access to the full range of printer features, HP strongly recommends that you install the software that is provided. Not all software is available in all languages. See the *Getting Started Guide* for installation instructions, and see the Readme file for the latest software information.

The most recent drivers, additional drivers, and other software are available from the Internet and other sources. If you do not have access to the Internet, see [HP Customer Care](#).

The printer supports the following operating systems:

- Microsoft® Windows® 98 Second Edition, Windows Millennium Edition (Me), and Windows® Server 2003 (Add Printer installation)
- Microsoft® Windows® 2000 and Windows XP
- Macintosh OS X v10.2 and later

The following tables list the software that is available for your operating system.

**Table 1-1** HP Color LaserJet 2605 series printer software

Feature	Windows 98 Second Edition, Me, and Server 2003	Windows 2000 and XP	Macintosh OS X v10.2 and later
Windows Installer		✓	
PCL printer driver	✓	✓	
PS printer driver	✓	✓	
HP Web Jetadmin software		✓	
HP ToolboxFX software		✓	
HP imaging software		✓	
Macintosh Installer			✓
Macintosh printer drivers			✓

## Software tips

The following are some tips for working with the printer software.

### How do I gain access to the printer features?

The printer features are available in the printer driver. Some features such as custom paper sizes and page orientation might also be available in the program you are using to create a file. Change

settings in the program, if possible, because changes that are made in the program override changes that are made in the printer driver.

Gain access to advanced printer features through the printer driver (or the **Print** dialog box for Macintosh operating systems). See [Gaining access to printer driver settings](#) for help with specific printer-driver features.

## How do I get the latest printing software?

When you want to check for and install upgrades to the printing software, you can download drivers from the World Wide Web or HP's file transfer protocol (FTP) servers.

### To download drivers

1. Go to <http://www.hp.com/support/clj2605>. Click the **support & drivers** block.
2. The Web page for the drivers might be in English, but you can download the drivers themselves in several languages.

If you do not have Internet access, contact HP Customer Care. (See [HP Customer Care](#) or the flyer that came in the printer box.) See the Readme file for additional release information.

## What other software is available?

See the Readme file that is provided on the HP Color LaserJet 2605 series CD-ROM for additional, included software and for supported languages.

# Print-media specifications

This section contains information about specifications for the quality of print media, guidelines for print media usage, and guidelines for print media storage.

## General guidelines

Some print media might meet all of the guidelines in this manual and still not produce satisfactory results. This problem might be the result of improper handling, unacceptable temperature and humidity levels, or other variables over which Hewlett-Packard has no control.

Before purchasing large quantities of print media, always test a sample and make sure that the print media meets the requirements specified in this user guide and in the *HP LaserJet Printer Family Print Media Guide*. For ordering information, see [Accessories and ordering information](#).



**CAUTION** Using print media that does not meet HP specifications can cause problems for the printer, requiring repair. This repair is not covered by the Hewlett-Packard warranty or service agreements.

**CAUTION** Use only paper designed for laser printers. Paper for inkjet printers may damage the printer.

This printer accepts a variety of media, such as cut-sheet paper (including up to 100% recycled-fiber-content paper), envelopes, labels, transparencies, HP LaserJet glossy paper, HP LaserJet Tough paper, HP LaserJet Photo paper, and custom-size paper. Properties such as weight, composition, grain, and moisture content are important factors that affect printer performance and output quality. Print media that does not meet the guidelines outlined in this manual can cause the following problems:

- Poor print quality
- Increased jams
- Premature wear on the printer, requiring repair

## Paper and print media

Category	Specifications
Acid content	5.5 pH to 8.0 pH
Caliper	0.094 to 0.18 mm (3.0 to 7.0 mils)
Curl in ream	Flat within 5 mm (0.02 inch)
Cut-edge conditions	Cut with sharp blades with no visible fray
Fusing compatibility	Must not scorch, melt, offset, or release hazardous emissions when heated to 210°C (410°F) for 0.1 second
Grain	Long Grain
Moisture content	4% to 6% by weight
Smoothness	100 to 250 Sheffield

For complete print-media specifications for all HP LaserJet printers, see the *HP LaserJet Printer Family Print Media Guide*. To download the guide in PDF format, go to <http://www.hp.com/support/ljpaperguide>.

## Printing and storage environment

Ideally, the printing and media-storage environment should be at or near room temperature, and not too dry or too humid. Remember that paper is hygroscopic; it absorbs and loses moisture rapidly.

Heat causes the moisture in paper to evaporate, while cold causes it to condense on the sheets. Heating systems and air conditioners remove most of the humidity from a room. As paper is opened and used, it loses moisture, causing streaks and smudging. Humid weather or water coolers can cause the humidity to increase in a room. As paper is opened and used it absorbs any excess moisture, causing light print and dropouts. Also, as paper loses and gains moisture it can distort. This issue can cause jams.

As a result, paper storage and handling are as important as the paper-making process itself. Paper storage environmental conditions directly affect the feed operation and print quality.

Care should be taken not to purchase more paper than can be easily used in a short time (about three months). Paper stored for long periods can experience heat and moisture extremes, which can cause damage. Planning is important to prevent damage to a large supply of paper.

Unopened paper in sealed reams can remain stable for several months before use. Opened packages of paper have more potential for environmental damage, especially if they are not wrapped with a moisture-proof barrier.

The media-storage environment should be properly maintained to ensure optimum printer performance. The recommended condition is 20° to 24°C (68° to 75°F), with a relative humidity of 45% to 55%. The following guidelines should be helpful when evaluating the paper's storage environment:

- Print media should be stored at or near room temperature.
- The air should not be too dry or too humid (to moderate the hygroscopic properties of paper).
- The best way to store an opened ream of paper is to rewrap it tightly in its moisture-proof wrapping. If the printer environment is subject to extremes, unwrap only the amount of paper to be used during the day's operation to prevent unwanted moisture changes.
- Avoid storing paper and print media near heating and air conditioning vents or near windows and doors that are frequently open.

## Envelopes

Envelopes can be printed from Tray 1 or Tray 2. Select the type of envelope that you are using from the **Print** dialog box or the printer driver.

In your program, set the margins for the envelope. The following table gives typical address margins for a commercial #10 or DL envelope.



Type of address	Top margin	Left margin
Return address	15 mm (0.6 inch)	15 mm (0.6 inch)
Delivery address	51 mm (2 inches)	89 mm (3.5 inches)

- For the best print quality, position margins no closer than 15 mm (0.6 inch) from the edges of the envelope.
- Avoid printing over the area where the envelope seams meet.

### Envelope storage

Proper storage of envelopes helps contribute to print quality. Envelopes should be stored flat. If air is trapped in an envelope and creates an air bubble, then the envelope might wrinkle during printing.

### Envelope construction

Envelope construction is critical. Envelope fold lines can vary considerably, not only between manufacturers, but also within a box from the same manufacturer. Successful printing on envelopes depends upon the quality of the envelopes. When selecting envelopes, consider the following components:

- **Weight:** The weight of the envelope paper should not exceed 90 g/m<sup>2</sup> (24 lb) or jamming might occur.
- **Construction:** Before printing, envelopes should lie flat with less than 6 mm (0.25 inch) curl, and should not contain air.
- **Condition:** Envelopes should not be wrinkled, nicked, stuck together, or otherwise damaged.

Never use envelopes that have clasps, snaps, windows, coated linings, self-stick adhesives, or other synthetic materials.

- **Temperature:** Use envelopes that are compatible with the heat and pressure of the printer. This printer's fusing temperature is 210°C (410°F).
- **Size:** Use only envelopes that are within the following size ranges.

Tray	Minimum	Maximum
Tray 1 or Tray 2	76 x 127 mm (3 x 5 inches)	216 x 356 mm (8.5 x 14 inches)

### Envelopes with double side-seams

Double side-seam construction has vertical seams at both ends of the envelope rather than diagonal seams. This style might be more likely to wrinkle. Be sure the seam extends all the way to the corner of the envelope as indicated in the following illustration.

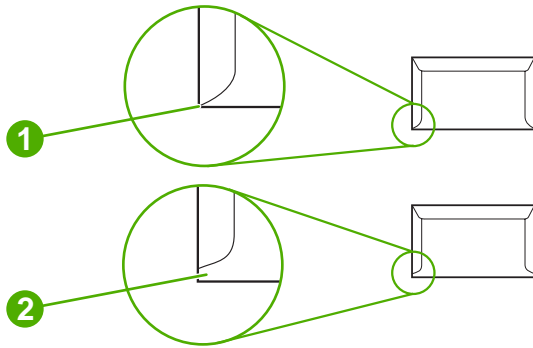

- |   |              |
|---|--------------|
| 1 | Acceptable   |
| 2 | Unacceptable |

### Envelopes with adhesive strips or flaps

Envelopes with a peel-off adhesive strip or with more than one flap that folds over to seal must use adhesives that are compatible with the heat and pressure in the printer. The extra flaps and strips might cause wrinkling, creasing, or even jams and might damage the fuser.

**CAUTION** Failure to follow the guidelines above can result in jams.

For instructions on loading envelopes, see [Loading Tray 1](#) or [Loading Tray 2](#).

### Labels

Select the type of label that you are using from the **Print** dialog box or the printer driver.

**CAUTION** To avoid damaging the printer, use only labels that are recommended for laser printers. To prevent serious jams, always use Tray 1 or Tray 2 to print on labels. Never print on the same sheet of labels more than once or print on a partial sheet of labels.

When selecting labels, consider the quality of each component:

- **Adhesives:** The adhesive material should be stable at 210°C (410°F), which is the printer fusing temperature.
- **Arrangement:** Only use labels with no exposed backing between them. Labels can peel off sheets with spaces between the labels, causing serious jams.
- **Curl:** Before printing, labels must lie flat with no more than 13 mm (0.5 inch) of curl in any direction.
- **Condition:** Do not use labels that have wrinkles, bubbles, other indications of separation, or are damaged in any way.

For instructions on loading labels, see [Loading Tray 1](#) or [Loading Tray 2](#).

## Transparencies

- Use only Tray 1 or Tray 2 to print on transparencies. Select **Transparencies** from the **Print** dialog box or the printer driver.
- The printer supports printing on color transparencies. Use only transparencies that are recommended for use in laser printers.
- Place transparencies on a flat surface after removing them from the printer.
- Transparencies that are used in the printer must be able to withstand 210°C (410°F), which is the printer fusing temperature.



---

**CAUTION** To avoid damage to the printer, use only transparencies that are recommended for use in laser printers. See [Accessories and ordering information](#).

Transparent print media that is not designed for LaserJet printing will melt in the printer, and will damage the printer.

---

## HP LaserJet glossy paper and HP LaserJet Photo paper

- Handle HP LaserJet glossy paper and HP LaserJet Photo paper by the edges. Oil from your fingers that is deposited on HP LaserJet glossy paper and HP LaserJet Photo paper can cause print-quality problems.
- Use only HP LaserJet glossy paper and HP LaserJet Photo paper with this printer. HP products are designed to work together for optimum printing results.

## Letterhead or preprinted forms

- Avoid using raised or embossed letterhead.
- Avoid using letterhead that is printed with low-temperature inks, such as those used in some types of thermography.
- The printer uses heat and pressure to fuse toner to the print media. Make sure that any colored paper or preprinted forms use inks that are compatible with this fusing temperature (210°C (410°F) for 0.1 second).

For instructions on loading letterhead, see [Loading Tray 1](#) and [Loading Tray 2](#).

## HP LaserJet Tough paper

When printing on HP LaserJet Tough paper, follow these guidelines:

- Handle HP LaserJet Tough paper by the edges. Oil from your fingers that is deposited on HP LaserJet Tough paper can cause print-quality problems.
- Use only HP LaserJet Tough paper with this printer. HP products are designed to work together for optimum printing results.

## Custom-sized print media or cardstock

- Postcards, 3 x 5-inch (index) cards, and other custom-sized print media can be printed on from Tray 1, Tray 2, or optional Tray 3. The minimum size is 76 x 127 mm (3 x 5 inches) and the maximum size is 216 x 356 mm (8.5 x 14 inches). See [Print-media specifications](#) for more information.
- Always insert the short edge first into Tray 1, Tray 2, or optional Tray 3. To print in landscape mode, make this selection through your program. Inserting the media long-edge-first might cause a jam.
- In your program, set margins at least 6.4 mm (0.25 inch) away from the edges of the print media.

For instructions on loading paper, see [Loading Tray 1](#) and [Loading Tray 2](#).

## Supported media weights and sizes

This section contains information about the sizes, weights, and capacities of paper and other print media that each tray supports.

**Table 1-2** Tray 1 and Tray 2 specifications

Tray 1 and Tray 2	Dimensions <sup>1</sup>	Weight	Capacity <sup>2</sup>
Paper	Minimum: 76 x 127 mm (3 x 5 inches)  Maximum: 216 x 356 mm (8.5 x 14 inches)	60 to 163 g/m <sup>2</sup> (16 to 43 lb)  Up to 176 g/m <sup>2</sup> (47 lb) for postcards	Single sheet of 75 g/m <sup>2</sup> (20 lb) paper for Tray 1  Up to 250 sheets for Tray 2
HP LaserJet glossy paper and HP LaserJet Photo paper <sup>4</sup>	Same as the preceding listed minimum and maximum sizes.	75 to 220 g/m <sup>2</sup> (20 to 58 lb)	Single sheet of HP LaserJet glossy paper or HP LaserJet Photo paper for Tray 1  Up to 25 mm (0.99 inch) stack height for Tray 2
HP Premium Cover paper <sup>4</sup>		200 g/m <sup>2</sup> (53 lb) cover	Single sheet of HP Cover paper for Tray 1  Up to 25 mm (0.99 inch) stack height for Tray 2
Transparencies and opaque film		Thickness: 0.10 to 0.13 mm (3.9 to 5.1 mils)	Single sheet of transparency or opaque film for Tray 1  Up to 50 sheets for Tray 2
Labels <sup>3</sup>		Thickness: up to 0.23 mm (up to 9 mils)	Single sheet of labels for Tray 1  Up to 25 mm (0.99 inch) stack height for Tray 2
Envelopes		Up to 90 g/m <sup>2</sup> (up to 24 lb)	Single envelope for Tray 1  Up to ten envelopes for Tray 2

<sup>1</sup> The printer supports a wide range of standard and custom sizes of print media. Check the printer driver for supported sizes.

<sup>2</sup> Capacity can vary depending on media weight and thickness, and environmental conditions.

<sup>3</sup> Smoothness: 100 to 250 (Sheffield).

<sup>4</sup> Hewlett-Packard does not guarantee results when printing with other types of heavy paper.

**Table 1-3** Optional Tray 3 specifications

Optional Tray 3 (250-sheet tray)	Dimensions <sup>1</sup>	Weight	Capacity <sup>2</sup>
Plain paper	Minimum: 76 x 127 mm (3 x 5 inches)  Maximum: 216 x 356 mm (8.5 x 14 inches)	60 to 163 g/m <sup>2</sup> (16 to 43 lb)	Up to 200 sheets

<sup>1</sup> The printer supports a wide range of standard and custom sizes of print media. Check the printer driver for supported sizes.

<sup>2</sup> Capacity can vary depending on the media weight and thickness, and environmental conditions.

**Table 1-4** Specifications for automatic 2-sided printing

Tray 1, Tray 2, and optional Tray 3	Dimensions <sup>1</sup>	Weight	Capacity <sup>2</sup>
Paper	Letter, A4, legal, 8.5 x 13 inches	60 to 105 g/m <sup>2</sup> (16 to 28 lb)	Single sheet for Tray 1  Up to 250 sheets for Tray 2 and optional Tray 3
HP LaserJet glossy paper	Letter, A4	75 to 120 g/m <sup>2</sup> (20 to 32 lb)	Single sheet for Tray 1  Up to 250 sheets for Tray 2 and optional Tray 3

<sup>1</sup> The printer supports a wide range of standard and custom sizes of print media. Check the printer driver for supported sizes.

<sup>2</sup> Capacity can vary depending on the media weight and thickness, and environmental conditions.



## 2 Software for Windows

When you install the software for Windows, you can directly connect the printer to a computer by using a USB cable or you can connect the printer to the network by using HP built-in networking. See the *Getting Started Guide* for installation instructions, and see the Readme file for the latest software information.

The following software is available to all users of the printer, whether you connected the printer directly to a computer by using a USB cable, or to the network through the HP built-in networking internal print server.

- [Printer drivers](#)
- [HP ToolboxFX](#)
- [Embedded Web server \(EWS\)](#)
- [HP Web Jetadmin](#)
- [Uninstalling the printing software](#)

## Printer drivers

A printer driver is a software component that provides access to printer features and provides the means for the computer to communicate with the printer. For help using your printer driver, see [Gaining access to printer driver settings](#).

Select a printer driver based on the way you use the printer.

- Use the PCL 6 printer driver to take full advantage of the printer features. Unless complete backward compatibility with previous PCL drivers or older printers is necessary, the PCL 6 driver is recommended.
- Use the PostScript (PS) printer driver for compatibility with PS needs. Certain printer features are not available in this printer driver. The printer automatically switches between PS 3 emulation and PCL printer languages depending on the driver you have selected.

### Using Help

The printer driver has **Help** dialog boxes that can be activated from the **Help** button in the printer driver, the **F1** key on the computer keyboard, or the question mark symbol (?) in the upper-right corner of the printer driver. These **Help** dialog boxes give detailed information about the specific printer driver. Help for the printer driver is separate from the Help for your program.



## HP ToolboxFX

You must perform a complete software installation to use the HP ToolboxFX.

The HP ToolboxFX provides links to printer status information and help information, such as this user guide; and tools for diagnosing and solving problems. You can also view explanations and animations on the control panel. See [HP ToolboxFX](#) for more information.

## Embedded Web server (EWS)

The EWS is a Web-based interface that provides simple access to printer status and configurations, including network configurations and Smart Printing Supplies (SPS) functionality.

You can gain access to the EWS through the network connection of the printer. Type the printer IP address in the Web browser to open the printer EWS homepage in the browser. From the homepage, you can use the tabs and left navigation menu to check the status of the printer, configure the printer, or check the status of the supplies.

- Internet Explorer 6.0 or later
- Safari 1.2 or later
- Opera 7.0 or later
- Firefox 1.0 or later
- Netscape 7.0 or later
- Mozilla 1.6 or later

# HP Web Jetadmin

This software is available only when the printer is connected to a network.

HP Web Jetadmin is intended for printer management in commercial and enterprise networks. While the HP ToolboxFX is used to manage a single printer, HP Web Jetadmin is used to manage groups of printers and other devices. Download this software from the HP website at <http://www.hp.com/go/webjetadmin>. The HP Web Jetadmin website provides HP Web Jetadmin software in many languages.

HP Web Jetadmin is available only if the printer is connected to an Internet protocol- (IP-) based network. This browser-based software can be installed on one of the following supported platforms:

- Microsoft Windows 2000 or XP
- Red Hat Linux
- SuSE Linux

After you install the HP Web Jetadmin software, you can start it in a supported Web browser on any computer by typing one of the following Web addresses:

- `http://server.domain:port/`

where `server.domain` is the server hostname and `port` is the port number that you selected during installation. (The default port is 8000.) This information is available in the `url.txt` file, which is stored in the folder where HP Web Jetadmin is installed.

- `http://ipaddress:port/`

where `ipaddress` is the IP address of the computer on which HP Web Jetadmin is installed.

For settings that appear in both the printer driver and HP Web Jetadmin, changes that are made in the printer driver override changes that are made in HP Web Jetadmin.

# Uninstalling the printing software

Uninstall software by using the following directions for your operating system.

## Uninstalling software for Windows

The printer comes with an uninstall utility that you can use to select and remove any or all of the Windows HP printing system components from your computer.

### To uninstall software for Windows 2000, XP, and Server 2003



---

**NOTE** To uninstall the software from Windows 2000, XP, or Server 2003, you must log on with administrator privileges.

---

1. Close all applications.
2. On the **Start** menu, point to **Programs**, point to **HP**, point to **HP Color LaserJet 2605**, and click **Uninstall HP Color LaserJet 2605 PCL6** or **HP Color LaserJet 2605\_dtn PCL6**.
3. On the Setup screen, click **Next**.
4. Click **Next**, and follow the directions on the screen. If the message **The following file is a shared file but is not used by any other programs. Would you like to delete it?** appears, click **Yes to All**. The system finishes removing files.
5. If prompted to restart the computer, click **OK**.

## Uninstalling software for Windows by using Add or Remove Programs

An alternate method for uninstalling the printer software is to use the **Add or Remove Programs** method. This method does *not* require you to have the software CD.

1. Click **Start**, point to **Settings**, and click **Control Panel**.
2. Click **Add or Remove Programs**.
3. Scroll through the list of software programs and click **HP Color LaserJet 2605** or **HP Color LaserJet 2605\_dtn PCL6** printer.
4. Click **Remove**.

# 3 Software for Macintosh

- [Software for Macintosh computers](#)
- [Printer drivers for Macintosh computers](#)
- [Using features in the Macintosh printer driver](#)
- [Managing printer color options on Macintosh computers](#)
- [Using Macintosh Configure Device](#)
- [Troubleshooting common Macintosh problems](#)

# Software for Macintosh computers

The HP installer provides PostScript® Printer Description (PPD) files, Printer Dialog Extensions (PDEs), and the Macintosh Configure Device for use with Macintosh computers.

If both the printer and the Macintosh computer are connected to a network, use the printer embedded Web server (EWS) to configure the printer. For more information, see [Using Macintosh Configure Device](#).

## Installing Macintosh printing system software for networks

This section describes how to install Macintosh printing system software. The printing system software supports Mac OS X v10.2 and later.

The printing system software includes the following components:

- **PostScript Printer Description (PPD) files**

The PPDs, in combination with the Apple PostScript printer drivers, provide access to printer features. An installation program for the PPDs and other software is provided on the compact disc (CD) that came with the printer. Use the Apple PostScript printer driver that comes with the computer.

- **Macintosh Configure Device**

The Macintosh Configure Device provides access to features that are not available in the printer driver. Use the illustrated screens to select printer features and complete the following tasks with the printer:

- Name the printer.
- Assign the printer to a zone on the network.
- Assign an internet protocol (IP) address to the printer.
- Configure and set the printer for network printing.

You can use the Macintosh Configure Device when your printer uses a universal serial bus (USB) or is connected to a TCP/IP-based network.

For more information about using the Macintosh Configure Device, see [Using Macintosh Configure Device](#).

### To install printer drivers for Mac OS X v10.2 and later

1. Connect the network cable between the HP Color LaserJet 2605, 2605dn, or 2605dtn printer and a network port.
2. Insert the CD into the CD-ROM drive and double-click the CD icon on the desktop.
3. Double-click the **Installer** icon in the HP LaserJet Installer folder.
4. Follow the instructions on the computer screen.
5. On the computer hard drive, open **Applications**, open **Utilities**, and then open **Print Center** or **Printer Setup Utility**.
6. Click **Add Printer**.

7. Select **Rendezvous** or **Bonjour** as the connection type.
8. Select your printer from the list.
9. Click **Add Printer**.
10. Close the Print Center or the Printer Setup Utility by clicking the close button in the upper-left corner.

## Installing Macintosh printing system software for direct connections (USB)

This section explains how to install the printing system software for Mac OS X v10.2 and later.

The Apple PostScript driver must be installed in order to use the PPD files. Use the Apple PostScript driver that came with your Macintosh computer.

### To install the printing system software

1. Connect a USB cable between the USB port on the printer and the USB port on the computer. Use a standard 2-meter (6.56-foot) USB cable.
2. Insert the printer CD into the CD-ROM drive and run the installer.  
Double-click the CD icon on the desktop.
3. Double-click the **Installer** icon in the HP LaserJet Installer folder.
4. Follow the instructions on the computer screen.



---

**NOTE** For Mac OS X v10.2 and later: USB queues are created automatically when the printer is attached to the computer. However, the queue will use a generic PPD if the installer has not been run before the USB cable is connected. To change the queue PPD, open the Print Center or Printer Setup Utility, select the correct printer queue, and then click **Show Info** to open the **Printer Info** dialog box. In the pop-up menu, select **Printer Model**, and then, in the pop-up menu in which **Generic** is selected, select the correct PPD for the printer.

---

5. Print a test page or a page from any software program to make sure that the software is correctly installed.

## To remove software from Macintosh operating systems

To remove the software from a Macintosh computer, drag the PPD files to the trash can.

# Printer drivers for Macintosh computers

The printer comes with printer-driver software that uses a printer language to communicate with the printer. Printer drivers provide access to printer features, such as printing on custom-sized paper, resizing documents, and inserting watermarks.

## Supported printer drivers

A Macintosh printer driver and the necessary PPD files are included with the printer.



**NOTE** The most recent drivers are available at [www.hp.com](http://www.hp.com).

## Gaining access to the printer drivers

Use one of the following methods to open the printer drivers from your computer.

Operating System	To change the settings for all print jobs until the software program is closed	To change the print job default settings (for example, turn on Print on Both Sides by default)	To change the configuration settings (for example, add a physical option such as a tray, or turn on or off a driver feature such as Allow Manual Duplexing)
Mac OS X v10.2	<ol style="list-style-type: none"><li>1. On the <b>File</b> menu, click <b>Print</b>.</li><li>2. Change any settings that you want to on the various pop-up menus.</li></ol>	<ol style="list-style-type: none"><li>1. On the <b>File</b> menu, click <b>Print</b>.</li><li>2. Change the settings that you want on the various pop-up menus, and then, on the <b>Presets</b> pop-up menu, click <b>Save as</b> and type a name for the preset.</li></ol> <p>These settings are saved in the <b>Presets</b> menu. To use the new settings, you must select the saved preset option every time you open a program and print.</p>	<ol style="list-style-type: none"><li>1. In the Finder, on the <b>Go</b> menu, click <b>Applications</b>.</li><li>2. Open <b>Utilities</b>, and then open <b>Print Center</b>.</li><li>3. Click on the print queue.</li><li>4. On the <b>Printers</b> menu, click <b>Show Info</b>.</li><li>5. Click the <b>Installable Options</b> menu.</li></ol> <p> <b>NOTE</b> Configuration settings might not be available in Classic mode.</p>
Mac OS X v10.3 or 10.4	<ol style="list-style-type: none"><li>1. On the <b>File</b> menu, click <b>Print</b>.</li><li>2. Change any settings that you want to on the various pop-up menus.</li></ol>	<ol style="list-style-type: none"><li>1. On the <b>File</b> menu, click <b>Print</b>.</li><li>2. Change the settings that you want on the various pop-up menus, and then, on the <b>Presets</b> pop-up menu, click <b>Save as</b> and type a name for the preset.</li></ol> <p>These settings are saved in the <b>Presets</b> menu. To use the new settings, you must select the saved preset option every time you open a program and print.</p>	<ol style="list-style-type: none"><li>1. Open <b>Printer Setup Utility</b> by selecting the hard drive, clicking <b>Applications</b>, clicking <b>Utilities</b>, and then double-clicking <b>Printer Setup Utility</b>.</li><li>2. Click on the print queue.</li><li>3. On the <b>Printers</b> menu, click <b>Show Info</b>.</li><li>4. Click the <b>Installable Options</b> menu.</li></ol>



# Using features in the Macintosh printer driver

When you print from a software program, many of the printer features are available from the printer driver. For complete information about the features that are available in the printer driver, see the printer-driver Help. The following features are described in this section:

- [Creating and using presets in Mac OS X](#)
- [Printing a cover page](#)
- [Printing multiple pages on one sheet of paper](#)
- [Printing on both sides of the paper](#)
- [Setting the color options](#)
- [Enabling memory](#)



---

**NOTE** Settings in the printer driver and software program generally override control-panel settings. Software-program settings generally override printer-driver settings.

---

## Creating and using presets in Mac OS X

Use presets to save the current driver settings for reuse. For example, you can save the page orientation, print-on-both-sides feature, and paper-type settings in a preset.

### To create a preset

1. Open the printer driver (see [Gaining access to the printer drivers](#)).
2. Select the print settings that you want to use.
3. In the **Presets** box, click **Save As...**, and type a name for the preset (for example "Quarterly Report" or "My Project Status").
4. Click **OK**.

### To use presets

1. Open the printer driver (see [Gaining access to the printer drivers](#)).
2. In the **Presets** menu, select the preset that you want to use.



---

**NOTE** To restore printer-driver default settings, select **Standard** from the **Presets** pop-up menu.

---

## Printing a cover page

If you want to, you can print a separate cover page for your document that includes a message (such as "Confidential").

### To print a cover page

1. Open the printer driver (see [Gaining access to the printer drivers](#)).
2. On the **Cover Page** or **Paper/Quality** pop-up menu, select whether to print the cover page **Before Document** or **After Document**.
3. In the **Cover Page Type** pop-up menu, select the message that you want to print on the cover page.



**NOTE** To print a blank cover page, select **Standard** as the **Cover Page Type**.

## Printing multiple pages on one sheet of paper

You can print more than one page on a single sheet of paper. This feature provides a cost-effective way to print draft pages.

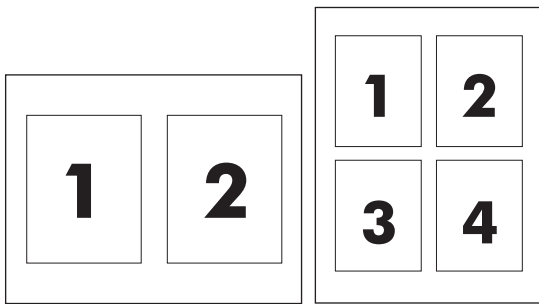

### To print multiple pages on one sheet of paper

1. Open the printer driver (see [Gaining access to the printer drivers](#)).
2. Click the **Layout** pop-up menu.
3. Next to **Pages per Sheet**, select the number of pages that you want to print on each sheet (1, 2, 4, 6, 9, or 16).
4. If the number of pages is greater than 1, next to **Layout Direction**, select the order and placement of the pages on the sheet.
5. Next to **Borders**, select the type of border to print around each page on the sheet.

## Printing on both sides of the paper

When a duplex printing accessory is installed, you can automatically print on both sides of a page. If a duplex printing accessory is not installed, you can manually print on both sides of a page by feeding the paper through the printer a second time.

### To print on both sides by using the duplex-printing accessory (HP Color LaserJet 2605dn and 2605dtn)

1. Insert enough paper into one of the trays to accommodate the print job. If you are loading special paper such as letterhead, load it in one of the following ways:
  - For tray 1, load the letterhead paper with the front side up and the bottom-edge feeding into the printer first.
  - For all other trays, load the letterhead paper with the front side down and the top edge at the back of the tray.



---

**CAUTION** Do not load paper that is heavier than 105 g/m<sup>2</sup> (28-lb bond) as it is not supported by the duplex accessory. Jamming might result.

---

2. Open the printer driver (see [Gaining access to the printer drivers](#)).
3. Open the **Layout** pop-up menu.
4. Next to **Two Sided Printing**, select either **Long-Edge Binding** or **Short-Edge Binding**.
5. Click **Print**.

### To print on both sides manually

1. Insert enough paper into one of the trays to accommodate the print job. If you are loading special paper such as letterhead, load it in one of the following ways:
  - For tray 1, load the letterhead paper with the front side up and the bottom-edge feeding into the printer first.
  - For all other trays, load the letterhead paper with the front side down, and the top edge at the back of the tray.
2. Open the printer driver (see [Gaining access to the printer drivers](#)).
3. On the **Finishing** pop-up menu, select the **Manual Duplex** option.



---

**NOTE** If the **Manual Duplex** option is not enabled, select **Manually Print on 2nd Side**.

---

4. Click **Print**.
5. Go to the printer. Remove any blank paper that is in Tray 2. Insert the printed stack with the printed side up and the bottom-edge feeding into the printer first. You must print the second side from Tray 2. Follow the instructions in the pop-up window that appears before replacing the output stack in Tray 2 for printing the second half.
6. If a prompt appears on the control-panel display, press a control-panel button to continue.

## Setting the color options

Use the **Color Options** pop-up menu to control how colors are interpreted and printed from software programs.



---

**NOTE** For more information about using the color options, see [Managing printer color options on Macintosh computers](#).

---

### To set the color options

1. Open the printer driver (see [Gaining access to the printer drivers](#)).
2. Select **Color Options**.
3. Click **Show Advanced Options**.
4. Manually adjust the individual settings for text, graphics, and photographs.

### Enabling memory

1. Open Print Center or Print Setup Utility.
2. Click HP LaserJet print queue to highlight it.
3. Choose **Show Info**.
4. On the **Name and Location** drop-down list, choose **Installable Options**.
5. On the **Total Printer Memory** list, choose the range which applies to your printer.
6. Click **Apply** to save the changes.

# Managing printer color options on Macintosh computers

Setting the color options to Automatic typically produces the best possible print quality for the most common printing requirements. However, for some documents, setting the color options manually can enhance the way the document appears. Examples of these documents include marketing brochures that contain many images or documents that are printed on a media type that is not listed in the printer driver.

Print color as gray or change the color options by using the **Printer Features** and **Color Options 2** pop-up menu in the **Print** dialog box.

For more information about how to gain access to the printer drivers, see [Gaining access to the printer drivers](#).

## Print Color as Gray

Selecting the **Print Color as Gray** option from the printer driver prints a document in black and shades of gray. This option is useful for previewing preliminary copies of slides and hardcopy output, or for printing color documents that will be photocopied or faxed.

## Advanced color options for text, graphics, and photographs

Use manual color adjustment to adjust the **Color** (or **Color Map**) and **Halftoning** options for a print job.

### Halftone options

Halftone options affect the resolution and clarity of your color output. You can select halftone settings independently for text, graphics, and photographs. The two halftone options are **Smooth** and **Detail**.

- The **Smooth** option provides better results for large, solid-filled print areas. It also enhances photographs by smoothing out fine color gradations. Select this option when uniform and smooth area fills are the top priority.
- The **Detail** option is useful for text and graphics that require sharp distinctions among lines or colors, or for images that contain a pattern or a high level of detail. Select this option when sharp edges and details are the top priority.



---

**NOTE** Some software programs convert text or graphics to raster images. In these cases, the **Photographs** settings also control text and graphics.

---

### Neutral Grays

The **Neutral Grays** setting determines the method that the printer uses to create gray colors in text, graphics, and photographs.

Two values are available for the **Neutral Grays** setting:

- **Black Only** generates neutral colors (grays and black) by using only black toner. This guarantees neutral colors that do not have a color cast.
- **4-Color** generates neutral colors (grays and black) by combining all four toner colors. This method produces smoother gradients and transitions to non-neutral colors, and it produces the darkest black.



---

**NOTE** Some software programs convert text or graphics to raster images. In these cases, the **Photographs** settings also control text and graphics.

---

## RGB Color

The **RGB Color** option determines how colors are rendered.

- Select **Default (sRGB)** for most printing needs. This setting instructs the printer to interpret RGB color as sRGB, which is the accepted standard of Microsoft and the World Wide Web Organization.
- Select **AdobeRGB** for documents that use the AdobeRGB color space rather than sRGB. For example, some digital cameras capture images in AdobeRGB, and documents that are produced with Adobe PhotoShop use the AdobeRGB color space. When printing from a professional software program that uses AdobeRGB, it is important that you turn off the color management in the software program and allow the printer software to manage the color space.
- **Photo Image** interprets the RGB color as if it were printed as a photograph using a digital mini-lab. It is designed to render the deeper, more saturated colors differently than Default mode. Use this setting for printing photos.
- **Device** sets the printer to print RGB data in raw device mode. To render photographs properly when this option is selected, you must manage color in the program in which you are working or in the operating system.
- **Vivid** instructs the printer to increase the color saturation in the midtones. Less colorful objects are rendered more colorfully. This value is recommended for printing business graphics.

## Edge Control

The **Edge Control** setting determines how edges are rendered. Edge control has three components: adaptive halftoning, Resolution Enhancement Technology (REt), and trapping. Adaptive halftoning increases the edge sharpness. Trapping reduces the effect of incorrect color alignment by slightly overlapping the edges of adjacent objects. The color REt option smooths the edges.



---

**NOTE** If you notice white gaps between objects, or if you notice areas that have a slight shadow of cyan, magenta, or yellow at the edge, choose an edge-control setting that increases the trapping level.

---

Four levels of edge control are available:

- **Maximum** is the most aggressive trapping setting. Adaptive halftoning and color REt settings are on.
- **Normal** is the default trapping setting. Trapping is at a medium level. Adaptive halftoning and color REt settings are on.
- **Light** sets trapping at a minimal level. Adaptive halftoning and color REt settings are on.
- **Off** turns off trapping, adaptive halftoning, and color REt.

# Using Macintosh Configure Device

Use Macintosh Configure Device to configure and maintain a printer from a Mac OS X v10.2 or v10.3 computer. This section describes several functions that you can perform through the Macintosh Configure Device.

## Macintosh Configure Device (Mac OS X V10.3 and Mac OS X V10.4)

Macintosh Configure Device is a Web-based program that provides access to information about the printer (for example, information about supplies status and printer settings). Use Macintosh Configure Device to monitor and manage the printer from the computer



---

**NOTE** You must perform a complete software installation to use Macintosh Configure Device.

---

- Check the printer status and print information pages.
- Check and change printer system settings.
- Check default print settings.
- Check and change network settings, including IP configuration, Advanced, mDNS, SNMP, network configuration, and password.

You can view Macintosh Configure Device when the printer is directly connected to your computer or when it is connected to the network.



---

**NOTE** You do not have to have Internet access to open and use Macintosh Configure Device.

---

### To view Macintosh Configure Device when the printer is directly connected to the computer

1. Open HP Director by clicking the **HP Director** icon in the dock.
2. In HP Director, click **Settings**.
3. Select **Configure device** to open the Macintosh Configure Device home page in a browser.

### To view Macintosh Configure Device when the printer is connected to a network

1. Open one of the following supported Web browsers:
  - Safari 1.2 or later
  - Microsoft Internet Explorer 5.0 or later
  - Netscape Navigator 4.75 or later
  - Opera 6.05 or later
2. Enter the IP address of the printer into the Web browser to open the Macintosh Configure Device home page.

# Troubleshooting common Macintosh problems

This section lists problems that can occur when using Mac OS X.

## Solving problems with Mac OS X

**Table 3-1** Problems with Mac OS X

### The printer driver is not listed in the Print Center or Printer Setup Utility.

Cause	Solution
The printer software might not have been installed or was installed incorrectly.	Make sure that the printer PPD is in the following hard-drive folder: <code>Library/Printers/PPDs/Contents/Resources/&lt;lang&gt;.lproj</code> , where <code>&lt;lang&gt;</code> is the two-letter language code for the language that you are using. If necessary, reinstall the software. See the <i>Getting Started Guide</i> for instructions.
The Postscript Printer Description (PPD) file is corrupt.	Delete the PPD file from the following hard-drive folder: <code>Library/Printers/PPDs/Contents/Resources/&lt;lang&gt;.lproj</code> , where <code>&lt;lang&gt;</code> is the two-letter language code for the language that you are using. Reinstall the software. See the <i>Getting Started Guide</i> for instructions.

### The printer name, IP address, or Rendezvous or Bonjour host name does not appear in the printer list in the Print Center or Printer Setup Utility.

Cause	Solution
The printer might not be ready.	Make sure that the cables are connected correctly, the printer is on, and the ready light is on. If you are connecting through a USB or Ethernet hub, try connecting directly to the computer or use a different port.
The wrong connection type might be selected.	Make sure that USB, IP Printing, or Rendezvous or Bonjour is selected, depending on the type of connection that exists between the printer and the computer.
The wrong printer name, IP address, or Rendezvous or Bonjour host name is being used.	Print a configuration page to check the printer name, IP address, or Rendezvous or Bonjour host name. Verify that the name, IP address, or Rendezvous or Bonjour host name on the configuration page matches the printer name, IP address, or Rendezvous or Bonjour host name in the Print Center or Printer Setup Utility.
The interface cable might be defective or of poor quality.	Replace the interface cable. Make sure to use a high-quality cable.

### The printer driver does not automatically set up your selected printer in the Print Center or Printer Setup Utility.

Cause	Solution
The printer might not be ready.	Make sure that the cables are connected correctly, the printer is on, and the ready light is on. If you are connecting through a USB or Ethernet hub, try connecting directly to the computer or use a different port.
The printer software might not have been installed or was installed incorrectly.	Make sure that the printer PPD is in the following hard-drive folder: <code>Library/Printers/PPDs/Contents/Resources/</code>



**Table 3-1** Problems with Mac OS X (continued)

**The printer driver does not automatically set up your selected printer in the Print Center or Printer Setup Utility.**

Cause	Solution
	<lang>.lproj, where <lang> is the two-letter language code for the language that you are using. If necessary, reinstall the software. See the <i>Getting Started Guide</i> for instructions.
The Postscript Printer Description (PPD) file is corrupt.	Delete the PPD file from the following hard-drive folder: Library/Printers/PPDs/Contents/Resources/<lang>.lproj, where <lang> is the two-letter language code for the language that you are using. Reinstall the software. See the <i>Getting Started Guide</i> for instructions.
The printer might not be ready.	Make sure that the cables are connected correctly, the printer is on, and the ready light is on. If you are connecting through a USB or Ethernet hub, try connecting directly to the computer or use a different port.
The interface cable might be defective or of poor quality.	Replace the interface cable. Make sure to use a high-quality cable.

**A print job was not sent to the printer that you wanted.**

Cause	Solution
The print queue might be stopped.	Restart the print queue. Open <b>print monitor</b> and select <b>Start Jobs</b> .
The wrong printer name or IP address is being used. Another printer with the same or similar name, IP address, or Rendezvous or Bonjour host name might have received your print job.	Print a configuration page to check the printer name, IP address, or Rendezvous or Bonjour host name. Verify that the name, IP address, or Rendezvous or Bonjour host name on the configuration page matches the printer name, IP address, or Rendezvous or Bonjour host name in the Print Center or Printer Setup Utility.

**You are unable to print from a third-party USB card.**

Cause	Solution
This error occurs when the software for USB printers is not installed.	When adding a third-party USB card, you might need the Apple USB Adapter Card Support software. The most current version of this software is available from the Apple Web site.

**When connected with a USB cable, the printer does not appear in the Print Center or Printer Setup Utility after the driver is selected.**

Cause	Solution
This problem is caused by either a software or a hardware component.	<b>Software troubleshooting</b> <ul style="list-style-type: none"><li>• Check that your Macintosh supports USB.</li><li>• Verify that your Macintosh operating system is Mac OS X v10.2 or later.</li><li>• Ensure that your Macintosh has the appropriate USB software from Apple.</li></ul>

**Table 3-1** Problems with Mac OS X (continued)

When connected with a USB cable, the printer does not appear in the Print Center or Printer Setup Utility after the driver is selected.

Cause	Solution
	<p data-bbox="794 300 1062 323"><b>Hardware troubleshooting</b></p> <ul data-bbox="794 348 1433 762" style="list-style-type: none"><li data-bbox="794 348 1171 371">• Check that the printer is turned on.</li><li data-bbox="794 401 1302 424">• Verify that the USB cable is connected correctly.</li><li data-bbox="794 453 1394 501">• Check that you are using the appropriate high-speed USB cable.</li><li data-bbox="794 531 1417 632">• Ensure that you do not have too many USB devices drawing power from the chain. Disconnect all of the devices from the chain, and connect the cable directly to the USB port on the host computer.</li><li data-bbox="794 661 1433 762">• Check to see if more than two nonpowered USB hubs are connected in a row on the chain. Disconnect all of the devices from the chain and connect the cable directly to the USB port on the host computer.</li></ul> <p data-bbox="842 791 895 846"></p> <p data-bbox="922 800 1401 846"><b>NOTE</b> The iMac keyboard is a nonpowered USB hub.</p>

# 4 Control panel

This section provides information about the control panel features.

- [Control panel features](#)

## Control panel features

The printer contains the following lights and buttons on the control panel:

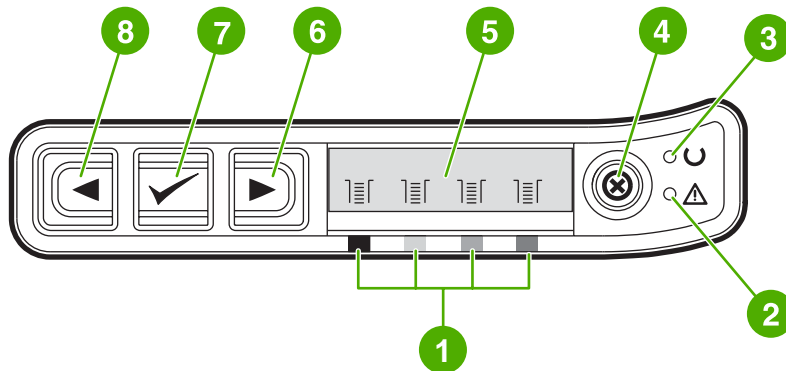

1 Color print cartridge indicators

2 Attention light (amber)

3 Ready light (green)

4 Cancel Job  button

5 Message area

6 Right arrow  button

7 Select  button

8 Left arrow  button

## Display

The printer's display gives you information about the printer, job status, and levels of supplies.

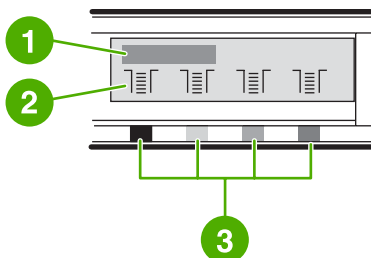

1 Message area





2 Supplies gauges

3 Print cartridge colors are indicated from left to right: black, yellow, cyan, and magenta

## Control panel menus

### Using the control panel menus

To gain access to the control panel menus, use the following steps.

1. Press **Select** .
2. Press the **Right arrow**  or **Left arrow**  button to navigate the listings.
3. Press **Select**  to select the appropriate option.
4. Press **Cancel Job**  to cancel an action or return to the Ready state.

### Control panel menu map

From the control panel Main menu, the following menus are available:



**NOTE** Default settings are indicated on the control panel by an asterisk (\*).

Menu	Sub-menus and options	Description
<b>Photo functions</b> (HP Color LaserJet 2605dtn only)	<ul style="list-style-type: none"><li>● <b>Print photos</b><ul style="list-style-type: none"><li>● <b>Job settings</b></li><li>● <b>Select Photos</b></li></ul></li><li>● <b>Index print</b><ul style="list-style-type: none"><li>● <b>Fast</b></li><li>● <b>Best</b></li></ul></li></ul>	Use these options to configure settings for printing photos.
<b>Reports</b>	<ul style="list-style-type: none"><li>● <b>Demo page</b></li><li>● <b>Menu structure</b></li><li>● <b>Config report</b></li><li>● <b>Supplies Status</b></li><li>● <b>Network report</b></li><li>● <b>Usage page</b></li><li>● <b>PCL font list</b></li><li>● <b>PS font list</b></li><li>● <b>PCLXL font list</b></li></ul>	Prints various printer reports.
<b>Photo Setup</b> (HP Color LaserJet 2605dtn only)	<ul style="list-style-type: none"><li>● <b>Def. image size</b></li><li>● <b>Def. # of copies</b></li><li>● <b>Def. output color</b></li></ul>	Use these options to set up defaults for photo printing.

Menu	Sub-menus and options	Description
<b>System setup</b>	<ul style="list-style-type: none"> <li>● <b>Language</b> (select desired language)</li> <li>● <b>Paper setup</b> <ul style="list-style-type: none"> <li>● <b>Def. paper size</b> (Letter, Legal, A4)</li> <li>● <b>Def. paper type</b> (select desired paper type)</li> <li>● <b>Tray 2</b> (select paper type and size)</li> <li>● <b>Paper out action</b> (Wait forever, Cancel, Override size)</li> </ul> </li> <li>● <b>Print quality</b> <ul style="list-style-type: none"> <li>● <b>Calibrate color</b></li> <li>● <b>Cartridge low</b></li> <li>● <b>Replace Supplies</b></li> </ul> </li> <li>● <b>Display contrast</b> (select desired contrast settings)</li> <li>● <b>Courier font</b> <ul style="list-style-type: none"> <li>● <b>Regular</b></li> <li>● <b>Dark</b></li> </ul> </li> </ul>	Use these menus to select system settings.
<b>Service</b>	<ul style="list-style-type: none"> <li>● <b>Restore defaults</b></li> <li>● <b>Cleaning Mode</b></li> <li>● <b>Less paper curl</b> <ul style="list-style-type: none"> <li>● <b>Off</b></li> <li>● <b>On</b></li> </ul> </li> <li>● <b>Archive print</b> <ul style="list-style-type: none"> <li>● <b>Off</b></li> <li>● <b>On</b></li> </ul> </li> </ul>	Use these menus to calibrate, restore factory default settings, and clean the print paper path.
<b>Network config.</b> (HP Color LaserJet 2605dn and 2605dtn)	<ul style="list-style-type: none"> <li>● <b>TCPIP config</b></li> <li>● <b>Link Speed</b></li> <li>● <b>Memory card</b></li> </ul>	Use these options to configure network settings.

## Understanding Supplies Status

The supplies gauges show the consumption levels of print cartridges (black, yellow, cyan, and magenta).

## Black, Yellow, Cyan, and Magenta Supplies Status gauges

A ? appears instead of the consumption level when the level is not known. This can occur in the following circumstances:

- Missing cartridges
- Incorrectly placed cartridges
- Cartridges with an error
- Some non-HP cartridges

The supplies gauge appears whenever the printer shows the Ready state with no warnings. It will also appear when the printer shows a warning or error message concerning a print cartridge or multiple supplies. If a supply is empty, the gauge will flash.

## Understanding Printer Status

The printer has four buttons and two lights to indicate and control the printer status.

### Cancel Job button

When the Ready light is blinking, pressing  (Cancel Job) cancels the current job.



---

**CAUTION** You might not receive any indication when a non-HP supply is empty. If you continue printing after the supply is empty, damage to the printer can occur. See [Hewlett-Packard limited warranty statement](#).

---

### Attention light

Generally, the Attention light blinks when the printer is out of paper, when a jam has occurred, or when other problems that need attention occur.



The Attention light blinks the first time a non-HP supply is installed.

When the Attention light is blinking, pressing  (Select) continues the print job after you load print media for a manual feed, or clears some errors.

### Ready light

The Ready light is on when the printer is ready to print (experiencing no errors that prevent printing) and blinks when it is receiving data to be printed.

### Left and Right arrow buttons

Use the  (Left arrow) and  (Right arrow) buttons to navigate through the printer control panel menus.

A Demo page can be printed by pressing the  (Left arrow) and  (Right arrow) buttons simultaneously.





# 5 Printing tasks

This section provides information about common printing tasks.

- [Loading trays](#)
- [Printing on special media](#)
- [Controlling print jobs](#)
- [Printing on both sides](#)
- [Canceling a print job](#)

For information about managing the printer and its settings by using the HP ToolboxFX, see [HP ToolboxFX](#).

## Loading trays

Use special print media, such as envelopes, labels, HP LaserJet glossy paper, HP LaserJet Photo paper, and transparencies in Tray 1 and Tray 2.



**NOTE** Because Tray 3 is not included for all models, it is referred to as optional Tray 3 in this guide.



**CAUTION** Do not fan paper before loading it into trays. Avoid overloading trays.

**CAUTION** Avoid reusing paper that has been stapled. Staples left in reused paper will cause printer damage that will require repairs that may not be covered under the warranty.

### Loading Tray 1

Tray 1 (the single sheet priority feed slot) prints single sheets of print media or a single envelope. Use Tray 1 when feeding one sheet of paper, envelope, postcard, label, HP LaserJet glossy paper, HP LaserJet Photo paper, or transparency. You can also use Tray 1 to print the first page on different media than the rest of the document.

1. Media guides ensure that the media is correctly fed into the printer and that the print is not skewed (crooked on the media). Slide the media-width guides slightly wider than the print media.

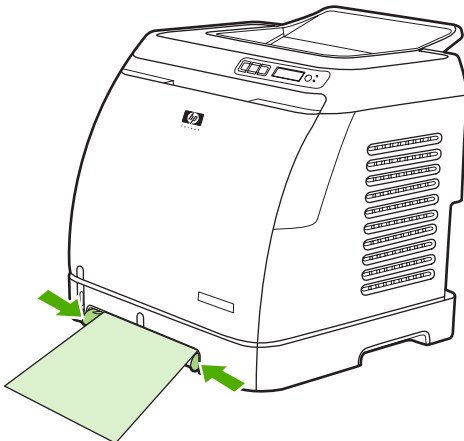

2. Feed print media into Tray 1 with the side to be printed down, and the top, short edge in first. Make sure that the media is inserted far enough into the printer for the paper feed mechanism to grab the media.

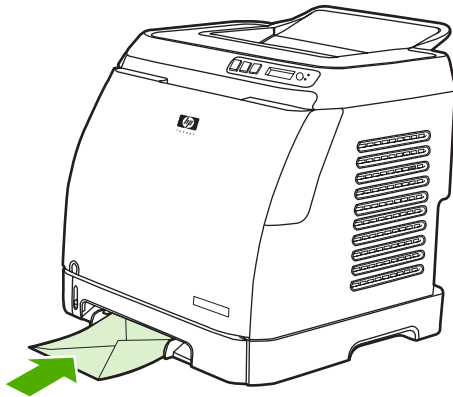
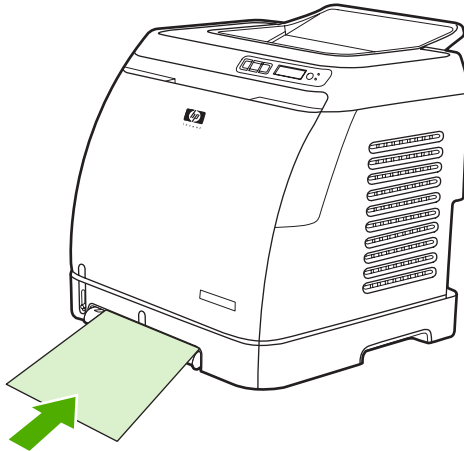

---

**NOTE** There is a short pause before the paper is picked up.

**NOTE** To load special media such as labels, transparencies, HP LaserJet glossy paper, HP LaserJet Photo paper, and letterhead or printed forms, feed or place the media with the side to be printed facing down. For additional information about printing on special print media, see [Printing on special media](#).

**NOTE** If you are printing on both sides, see [Printing on both sides](#) for loading instructions.

---

## Loading Tray 2

Tray 2 and optional Tray 3 are accessed from the front of the printer and hold up to 250 sheets of paper. Tray 2 also supports other media such as envelopes, postcards, transparencies, HP LaserJet glossy paper, and HP LaserJet Photo paper.



---

**NOTE** Tray 3 is standard on HP Color LaserJet 2605dtn.

**NOTE** Instructions are the same for loading media in Tray 2 and optional Tray 3.

---

1. Pull Tray 2 or optional Tray 3 out of the printer and remove any paper.

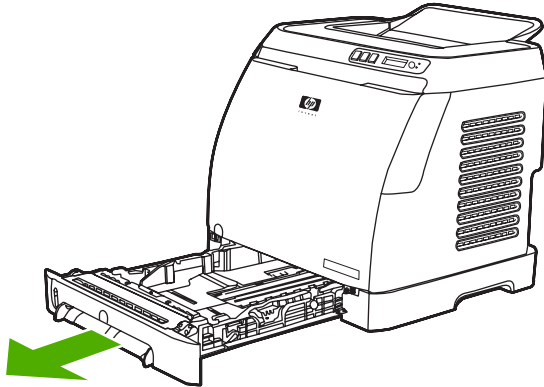

2. Move the rear guides to match the size of paper that you are loading. Tray 2 and optional Tray 3 accept several standard paper sizes.

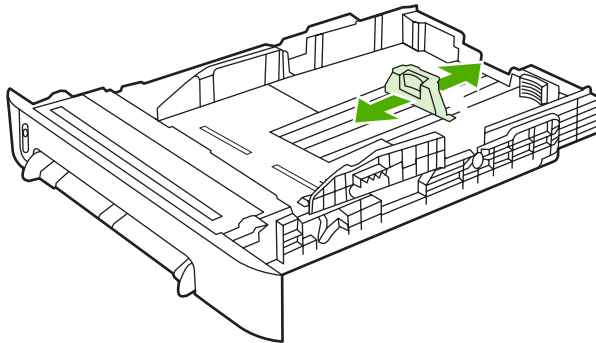

3. If printing paper longer than Letter/A4, extend the rear of the tray until it matches the size you are loading.

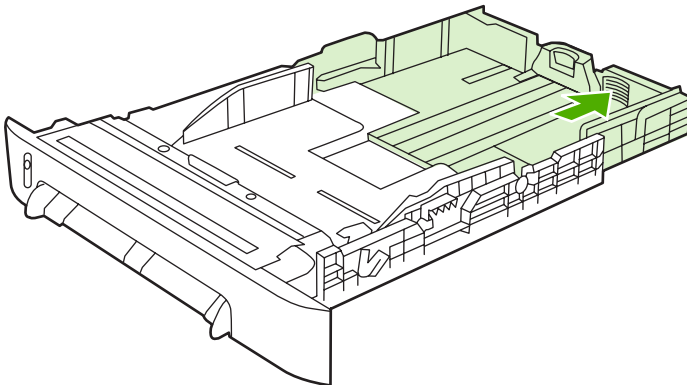

4. Slide the media-width guides slightly wider than the print media.

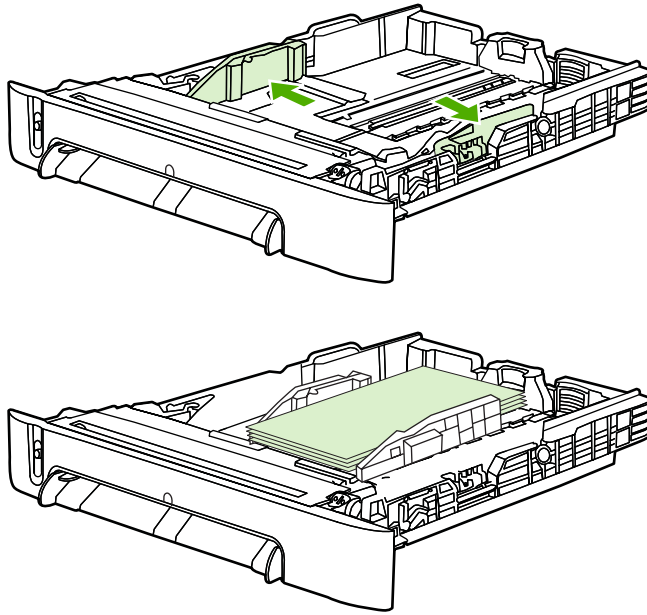

---

**NOTE** Load 10 envelopes or less into Tray 2 with the flaps on the right side, the side to be printed facing up, and with the short edge leading into the printer. If the envelope has a flap on a short edge, this edge must enter the printer first.

---

5. Load the media.

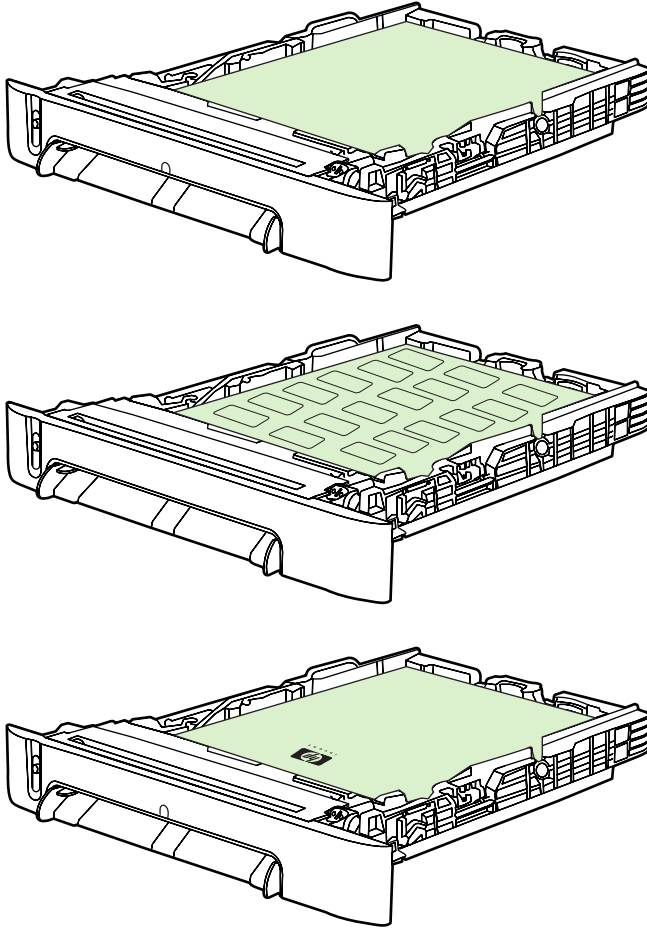

**NOTE** If this is special paper such as labels, transparencies, HP LaserJet glossy paper, HP LaserJet Photo paper, and letterhead or printed forms, load it with the side to be printed on facing up and the top edge toward the front of the tray. For additional information about printing on special print media, see [Printing on both sides](#).

6. Make sure that the stack of paper is flat in the tray at all four corners, and keep it below the height tabs on the media-length guide in the rear of the tray.

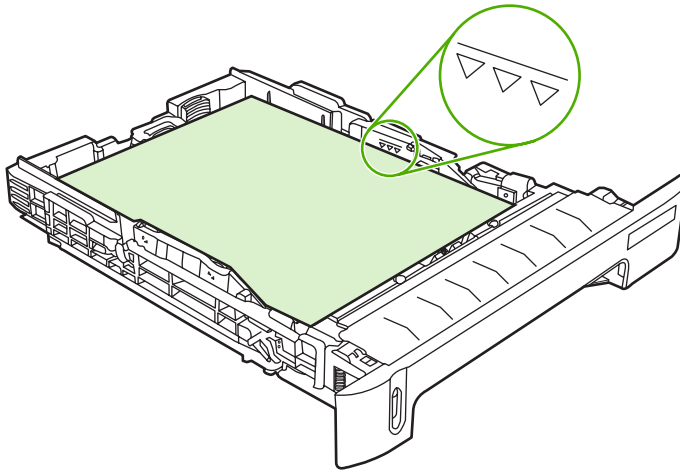

7. Slide the tray into the printer. The back of the tray will protrude from the back of the printer.

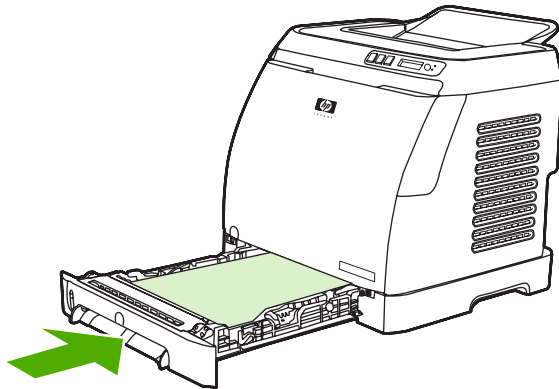

---

**NOTE** If you are printing on both sides, see [Printing on both sides](#) for loading instructions.

---

## Printing on special media

Use the guidelines in following table when printing on special media. When printing on a special type of media, printing speeds might be automatically reduced to improve the output quality for that specific media. See [Print-media specifications](#) for media that is recommended for this printer. For instruction on loading the trays, see [Loading Tray 1](#) or [Loading Tray 2](#).

**Table 5-1** Special media printing guidelines

Paper type	Maximum amount that can be loaded into Tray 2 or optional Tray 3	Driver settings, paper quality, type is	Tray 1 paper orientation	Tray 2 or optional Tray 3 paper orientation
Normal	Up to 250 sheets	Plain or unspecified	Side to be printed face down	Side to be printed face up
Envelopes	Up to 10 envelopes	Envelope	Short edge leading, flap on right side facing down	Short edge leading, flap on right side facing up
Heavy envelopes	Up to 10 envelopes	Heavy envelope	Short edge leading, flap on right side facing down	Short edge leading, flap on right side facing up
Labels	Up to 25 mm (0.99 inch) stack height	Labels	Side to be printed face down	Side to be printed face up
Transparencies	Up to 50 sheets	Transparencies	Side to be printed face down	Side to be printed face up
Glossy	Up to 25 mm (0.99 inch) stack height	Light glossy, glossy, or heavy glossy	Side to be printed face down	Side to be printed face up
Letterhead	Up to 250 sheets	Letterhead	Side to be printed face down, printed edge at front of tray	Side to be printed face up, printed edge at front of tray
Cardstock	Up to 25 mm (0.99 inch) stack height	Cardstock or heavy	Side to be printed face down	Side to be printed face up



# Controlling print jobs

This section provides basic printing instructions. When making changes to printing settings, follow the hierarchy of how changes are prioritized. (Note that the names of commands and dialog boxes might vary depending on your software program.)

- **Page Setup dialog box.** This dialog box opens when you click **Page Setup** or a similar command on the **File** menu in your software program. This dialog box is part of the program in which you are working. *Settings that are changed here override settings that are changed anywhere else.*
- **Print dialog box.** This dialog box opens when you click **Print**, **Print Setup**, or a similar command on the **File** menu in your software program. It is also part of the program, but it has a lower priority than the **Page Setup** dialog box. Settings that are changed in the **Print** dialog box *do not* override settings that are changed in the **Page Setup** dialog box. Settings that are changed here *do* override settings that are changed in the printer driver.
- **Printer driver.** The printer driver opens when you click **Properties** in the **Print** dialog box. Settings that are changed here *do not* override settings that are changed anywhere else.

## Settings for selecting print media

Three settings affect how the printer driver tries to pull media when you send a print job. These settings, **Source**, **Type**, and **Size**, appear in your program **Page Setup** dialog box, the **Print** dialog box, or the printer driver. The printer automatically selects a tray if you do not change these settings. If you do want to change these settings, you can print by **Source**, by **Type**, by **Size**, or by **Type** and **Size**.

- **Source.** Printing by **Source** means that you select a specific tray from which you want the printer to pull paper. The printer tries to print from this tray, no matter what type or size is loaded in it. However, if you select a tray that is configured from the HP ToolboxFX for a type or size and that does not match your print job, the printer does not print automatically. Instead, it waits for you to load the tray that you selected with the type or size of print media for your print job. When you load the tray, the printer begins printing. (If the printer does not begin printing, you might need to configure the tray to match the size or type of the print job.) Or, press  (**Select**) to have the printer try to print from another tray.
- **Type or Size.** Printing by **Type** or **Size** means that you want the printer to pull paper or print media from the first tray that is loaded with the type or size that you selected. *Always print by Type for special print media such as labels or transparencies.*
  - If you want to print by **Type** or **Size** and the trays have not been configured for a certain type or size from the HP ToolboxFX, load the paper or print media into a tray and then select the **Type** or **Size** from the **Page Setup** dialog box, the **Print** dialog box, or the printer driver.
  - If you often print on a certain type or size of media, the printer administrator (for a network printer) or you (for a directly connected printer) can use the HP ToolboxFX to configure a tray for that type or size. (See [HP ToolboxFX](#).) Then, when you select that Type or Size as you print a job, the printer pulls from the tray that is configured for that type or size.

## Features in the printer driver

Some printer drivers and some operating systems do not support all of these printer features.

- Setting a custom paper size
- Printing in grayscale
- Changing the color settings
- Creating and using watermarks
- Printing multiple pages on one sheet of paper (N-up printing)
- Creating and using Quick Sets
- Reducing or enlarging
- Printing on different paper for the first page
- Changing the print quality
- Restoring the default printer-driver settings

For printing using the Print on Both Sides (manually) feature, see [Printing on both sides](#).

### Setting a custom paper size

Use the Custom Paper feature to set up the printer to print to sizes other than standard ones.

Try to set this setting from *one* of these locations, in this order: the **Page Setup** dialog box in the program, the **Print** dialog box in the program, or the **Paper** tab in the printer driver.

### Printing in grayscale

If you have a document that you created in color, it will automatically print in color. Or, you can set the printer to print a color document in grayscale (black and white) only.

Select the **Print In Grayscale** option on the **Color** tab of the printer driver.

### Changing the color settings

When you are printing in color, the printer driver automatically sets the optimal color settings for you. However, you can manually make adjustments to how the printer prints in color for text, graphics, and photographs. See [Printing on special media](#) for more information.

On the **Color** tab of the printer driver, click **Settings**.

### Creating and using watermarks

Use the Watermark options to specify that text be placed "underneath" (in the background of) an existing document. For example, you might want to have large gray letters reading "draft" or "confidential" placed diagonally across the first page or all pages of a document. You can change color, position, and wording of the watermark.

Gain access to the **Watermark** options on the **Effects** tab in your printer driver.



---

**NOTE** If you are using Windows 2000 or XP, you must have Administrator privileges to create watermarks. You do not need Administrator privileges to add existing watermarks to documents.

---

### Printing multiple pages on one sheet of paper (N-up printing)

N-up printing is the ability to print multiple pages on one sheet of paper. The pages will appear decreased in size. You can specify up to nine pages per sheet, and they will be arranged on the sheet as shown in the following figures if you use the default arrangement. You can also choose whether a border appears around each page or not.

Gain access to **Pages per Sheet** on the **Finishing** tab in the printer driver.

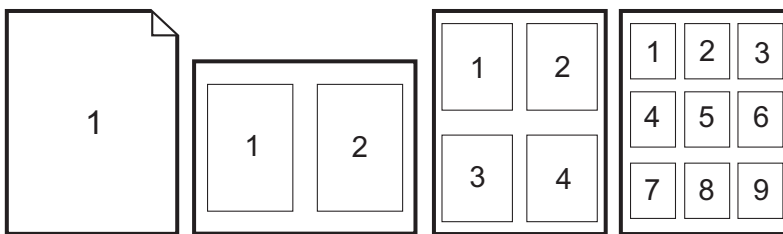

### Creating and using Quick Sets

Use Quick Sets to save the current print-driver settings such as the page orientation, N-up printing, or the paper source for later use. You can save up to a total of 30 sets of settings. For convenience, Quick Sets can be selected and saved from most printer-driver tabs.



---

**NOTE** If you are using Windows 2000, you must have Administrator privileges to save Quick Sets.

---

Create Quick Sets from most printer-driver tabs. Later, you can gain access to Quick Sets on the **Finishing** tab in the printer driver.

### Reducing or enlarging

Use the **Fit to Page** option to scale your document to a percentage of its normal size. You can also choose to scale your document to fit on any size of paper that the printer supports.

Gain access to **Fit to Page** settings on the **Effects** tab in the printer driver.

### Printing on different paper for the first page

Printing on different paper for the first page is useful if, for example, you are printing a letter that uses letterhead on the first page and plain sheets for the subsequent pages. The size for all pages of the print job must be the same in the printer driver.

Try to set this setting from *one* of these locations, in this order: the **Page Setup** dialog box in the program, the **Print** dialog box in the program, or the **Paper/Quality** tab in the printer driver.

## Restoring the default printer-driver settings

You can return all settings in the printer driver to their default values. This feature might be useful if you are experiencing quality issues, or if the print media is not being selected from the correct tray.

Select **Defaults** in the **Quick Sets** dialog box on the **Finishing** tab of the printer driver.

## To print from Windows

1. Make sure that print media is loaded in the printer.
2. On the **File** menu, click **Page Setup** or a similar command. Make sure that the settings are correct for this document.
3. From the **File** menu, click **Print**, **Print Setup**, or a similar command. The **Print** dialog box opens.
4. Select this printer and change settings as necessary. Do not change any settings, such as page size or orientation, that you set in the **Page Setup** dialog box.
5. If this print job is for a standard size and weight of paper, you probably do not need to change the **Source is** (tray), **Type is**, or **Size is** settings, and you can go to step 7. Otherwise, go to step 6.
6. If this print job is to be printed on a non-standard size or weight of paper, select how the printer pulls paper.
  - To print by Source (tray), select the tray in the **Print** dialog box, if possible.
  - To print by Source (tray) when this setting is not available in the **Print** dialog box, click **Properties**, and on the **Paper** tab, select the tray in the **Source is** field.
  - To print by Type or Size, click **Properties** and, on the **Paper** tab, select the type or size in the **Type is** or **Size is** field. (For some paper, such as letterhead, you will set both the Type and Size.) *Always print by Type for special print media such as labels or transparencies.*
7. If you have not yet done so, click **Properties**. The printer driver opens.
8. On the various tabs, set any settings that you want that did not appear in the **Page Setup** or **Print** dialog box. For more information about printer-driver settings, see [Features in the printer driver](#).
9. Select the **Print** command to print the job.

## Gaining access to printer driver settings

This section lists the common printing features that are controlled through the printer driver. (The printer driver is the software component you use to send print jobs to the printer.) You can change settings temporarily for the print jobs that you print while the program is still open. You can also make permanent changes to the default settings, and those new settings will be in effect now and in the future.

Operating System	Temporarily change settings for jobs that are printed now	Permanently change default settings <sup>1</sup>	Change configuration settings  (For example, to add an optional tray or to enable or disable a driver feature such as "Allow manual duplexing")
Windows 98 Second Edition and Me	On the <b>File</b> menu, click <b>Print</b> , select this printer, and then click <b>Properties</b> . (The actual steps can vary; this is the most common method.)	Click <b>Start</b> , point to <b>Settings</b> , and then click <b>Printers</b> . Right-click the printer icon, and then click <b>Properties</b> .	Click <b>Start</b> , point to <b>Settings</b> , and then click <b>Printers</b> . Right-click the printer icon, and then click <b>Properties</b> . Click the <b>Configure</b> tab.
Windows 2000 and XP (Classic Start Menu)	On the <b>File</b> menu, click <b>Print</b> , select this printer, and then click <b>Properties</b> or <b>Preferences</b> . (The actual steps can vary; this is the most common method.)	Click <b>Start</b> , point to <b>Settings</b> , and then click <b>Printers</b> or <b>Printers and Faxes</b> . Right-click the printer icon, and then click <b>Printing Preferences</b> .	Click <b>Start</b> , point to <b>Settings</b> , and then click <b>Printers</b> or <b>Printers and Faxes</b> . Right-click the printer icon, and then click <b>Properties</b> . Click the <b>Configure</b> tab.
Windows XP	On the <b>File</b> menu, click <b>Print</b> , select this printer, and then click <b>Properties</b> or <b>Preferences</b> . (The actual steps can vary; this is the most common method.)	Click <b>Start</b> , click <b>Printers and Faxes</b> , right-click the printer name or icon, and then click <b>Printing Preferences</b> .	Click <b>Start</b> and then click <b>Printers and Faxes</b> . Right-click the printer icon, and then click <b>Properties</b> . Click the <b>Configure</b> tab.

<sup>1</sup> Access to default printer settings might be restricted and therefore unavailable.

## Printing on both sides

To print on both sides of the paper, you have to return to the printer and reinsert the paper manually after the first side has printed.



**CAUTION** Do not print on both sides of labels or transparencies. Damage to the printer and jams might result.

### To print on both sides (manually)

1. Insert enough paper into Tray 2 or optional Tray 3 to accommodate the print job.

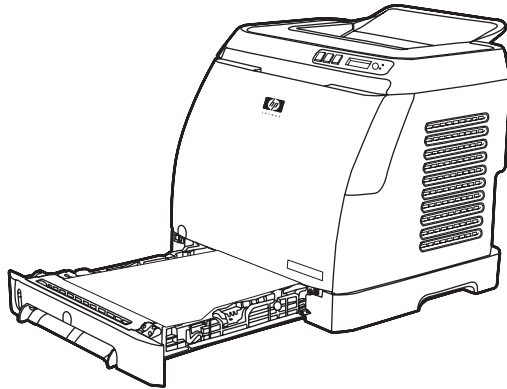

**NOTE** In Windows, **Print on both sides (manually)** must be enabled to complete these instructions. To enable duplexing, in the printer driver, select **Properties**, and then click on the **Configure** tab. Under Paper handling, select **Allow Manual Duplexing**, and then click **OK** to save.

2. Use the following procedure to configure the printer to Print on both sides (manually).

In the printer driver, select the **Finishing** tab, select the **Print on both sides (manually)** option, and then send the job to print.

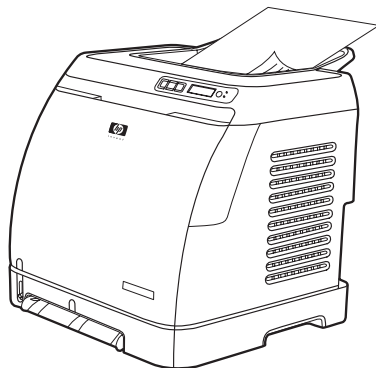

3. After the job is finished printing, remove any blank paper as prompted by the control panel. Lift the printed stack from the output bin and insert the printed stack without rotating or turning the stack over into the printer tray that was used for the first part of the job.

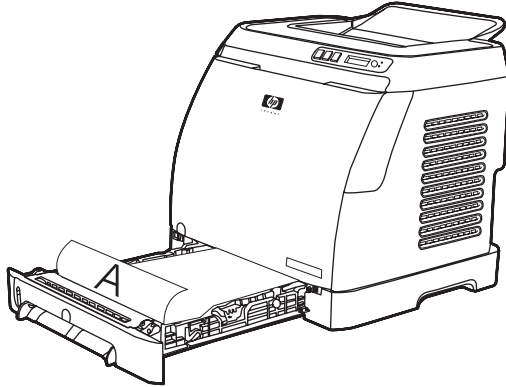

4. Press  (Select) to continue printing on the second side.

#### To print on both sides (automatically) (HP Color LaserJet 2605dn and 2605dtn)

Perform the following steps to print on both sides (automatically). To check for supported media for 2-sided printing, see [Print-media specifications](#).

1. Verify that the printer driver is configured for 2-sided printing. For instructions, see the online help for the printer driver.
2. Select the appropriate 2-sided printing options in the printer driver software, including page and binding orientation.



---



**NOTE** When using 2-sided printing, load pre-printed forms and letterhead into Tray 1 face-up with the bottom edge of the page feeding first. Load preprinted forms and letterhead into Tray 2 and Tray 3 face-down with the top edge at the back of the tray.

**NOTE** Loading pre-printed forms and letterhead is different than loading for 1-sided printing.

---

## Canceling a print job

A print job can be canceled from a program, from a print queue, or from the  (**Cancel Job**) button on the printer.

- If the printer has not started printing, first try to cancel the job within the program that sent the print job.
- If the print job is waiting in a print queue or print spooler such as the **Printers** folder (**Printers or faxes** in Windows 2000 or Windows XP), try to delete the job from there next.
- If the print job is already printing, press  (**Cancel Job**) on the printer. The printer finishes printing any pages that are already moving through the printer and deletes the remainder of the print job.
- Pressing  (**Cancel Job**) cancels only the current job in the printer. If more than one print job is in printer memory, you must press  (**Cancel Job**) once for each job after the job starts printing.

The Ready light will blink and the **Cancelling print** will display in the message area.



# 6 Color

This chapter describes how the printer provides great color printing. This chapter also describes ways to produce the best possible color prints. The following topics are covered:

- [Using color](#)
- [Managing color options](#)
- [Matching colors](#)

## Using color

This printer offers great color as soon as you set it up. It provides a combination of automatic color features to generate excellent color results for the general user, plus sophisticated tools for the experienced color user.

The printer provides carefully designed and tested color tables to provide smooth, accurate color rendition of all printable colors.

HP provides free online tools to help businesses of all sizes with their color printing. HP's Office Color Printing Center (<http://www.hp.com/go/color>) identifies solutions and information on creating finished projects.

### HP ImageREt 2400

ImageREt 2400 provides 2400 dots-per-inch (dpi) color laser-class quality through a multi-level printing process. This process precisely controls color by combining up to four colors within a single dot and by varying the amount of toner in a given area. ImageREt 2400 has been improved for this printer. The improvements offer trapping technologies, greater control over dot placement, and more precise control of toner quality in a dot. These new technologies, coupled with HP's multi-level printing process, result in a 600 x 600 dpi printer that provides 2400-dpi color laser-class quality with millions of smooth colors.

In contrast, the single-level printing process found in the default mode of other color laser printers does not allow the colors to be mixed within a single dot. This process, called dithering, significantly hinders the ability to create a wide range of colors without reduced sharpness or visible dot structure.

### Media selection

For the best color and image quality, it is important to select the appropriate media type from the software printer menu or from the printer driver. See [Print-media specifications](#) for more information.

### Color options

Color options enable optimal color output automatically for diverse types of documents.

Color options use object tagging, which allows optimal color settings to be used for different objects (text, graphics, and photos) on a page. The printer driver determines which objects are used on a page and uses color settings that provide the best print quality for each object. Object tagging, combined with optimized default settings, produces great color from the printer without having to establish any special settings.

In the Windows environment, the **Automatic** and **Manual** color options are on the **Color** tab in the printer driver.

### Standard red-green-blue (sRGB)

Standard red-green-blue (sRGB) is a worldwide color standard that was originally developed by HP and Microsoft as a common color language for monitors, input devices (scanners and digital cameras), and output devices (printers and plotters). It is the default color space that is used for HP products, Microsoft operating systems, the World Wide Web, and most office software that is sold today. The sRGB standard is representative of the typical Windows computer monitor and is the convergence standard for high-definition television.



---

**NOTE** Factors such as the type of monitor you use and the room's lighting can affect the appearance of colors on your screen. For more information, see [Matching colors](#).

---

The latest versions of Adobe® PhotoShop®, CoreIDRAW™, Microsoft Office, and many other applications use sRGB to communicate color. Most importantly, as the default color space in Microsoft operating systems, sRGB has gained broad adoption as a way to exchange color information between software programs and devices by using a common definition that assures that typical users will experience greatly improved color matching. The sRGB standard improves your ability to match colors between the printer, the computer monitor, and other input devices (scanners and digital cameras) automatically, without the need to become a color expert.

# Managing color options

Setting color options to **Automatic** typically produces the best possible print quality for color documents. However, in some situations, you might want to print a color document in grayscale (black and shades of gray) or to change one of the printer's color options.

Print in grayscale or change the color options by using the settings on the **Color** tab in the printer driver.

## Print in Grayscale

Selecting the **Print in Grayscale** option from the printer driver prints a document in black and shades of gray. This option is useful for printing color documents that will be photocopied or faxed.

When **Print in Grayscale** is selected, the printer goes into monochrome mode.

Selecting **Print in Grayscale** in the **Print Quality** options on the **Paper Quality** tab, will allow you to change the settings to accommodate the types of jobs that you are printing. The following are the settings:

- **FastRes 1200:** This setting uses FastRes 1200 to provide fine-line detail at 1200 x 1200 dpi.
- **ProRes 1200:** This setting provides ProRes 1200 output with Resolution Enhancement technology (REt) for improved text.

## Automatic versus Manual color adjustment

The **Automatic** color adjustment option optimizes the neutral gray color treatment, and the edge enhancements that are used for each element in a document. For more information, see your printer-driver online Help.



---

**NOTE** **Automatic** is the default setting and is recommended for printing all color documents.

---

Use the **Manual** color adjustment option to adjust the neutral gray color treatment, and the edge enhancements for text, graphics, and photographs. To gain access to the Manual color options, on the **Color** tab, click **Manual**, and then click **Settings**.

## Change color options

Use the Manual color adjustment to adjust the **Color** (or **Color Map**) options.



---

**NOTE** Some software programs convert text or graphics to raster images. In these cases, the **Photographs** setting also controls the text and graphics.

---

## Halftone options

Halftoning is the method by which the printer mixes the four primary colors (cyan, magenta, yellow, and black) in varying proportions to create millions of colors. Halftone options affect the resolution and clarity of your color output. The two halftone options are **Smooth** and **Detail**.

- The **Smooth** option provides better results for large, solid-filled print areas. It also enhances photos by smoothing out fine color gradations. Choose this option when uniform and smooth area fills are the most important attributes.
- The **Detail** option is useful for text and graphics that require sharp distinctions among lines or colors, or images that contain a pattern or a high level of detail. Choose this option when sharp edges and details are the most important attributes.

## Edge Control

The **Edge Control** setting determines how edges are rendered. Edge Control consists of two components: Adaptive Halftoning and Trapping. Adaptive Halftoning increases the edge sharpness. Trapping reduces the effect of color-plane misregistration by slightly overlapping the edges of adjacent objects. The following levels of edge control are available:

- **Off** sets Trapping and Adaptive Halftoning to Off.
- **Normal** provides the default trapping settings. Adaptive Halftoning is set to On.
- **Maximum** provides the most trapping. Adaptive Halftoning is set to On.

## RGB Color

The **RGB Color** option determines how colors are rendered.

- Select **Default (sRGB)** for most printing needs. This setting instructs the printer to interpret RGB color as sRGB, which is the accepted standard of Microsoft and the World Wide Web Organization.
- Select **AdobeRGB** for documents that use the AdobeRGB color space rather than sRGB. For example, some digital cameras capture images in AdobeRGB, and documents that are produced with Adobe PhotoShop use the AdobeRGB color space. When printing from a professional software program that uses AdobeRGB, it is important that you turn off the color management in the software program and allow the printer software to manage the color space.
- **Photo Image** interprets the RGB color as if it were printed as a photograph using a digital mini-lab. It is designed to render the deeper, more saturated colors differently than Default mode. Use this setting for printing photos.
- **Device** sets the printer to print RGB data in raw device mode. To render photographs properly when this option is selected, you must manage color in the program in which you are working or in the operating system.
- **Vivid** instructs the printer to increase the color saturation in the midtones. Less colorful objects are rendered more colorfully. This value is recommended for printing business graphics.

## Neutral Grays

The **Neutral Grays** setting determines the method for creating gray colors that are used in text, graphics, and photographs.

- **Black Only** generates neutral colors (grays and black) by using only black toner. This option guarantees that neutral colors do not have a color cast.
- **4-Color** generates neutral colors by combining all four colors of toner. This option produces smoother gradients and transitions to non-neutral colors. It also produces the darkest possible black.

# Matching colors

The process of matching printer output color to your computer screen is quite complex because printers and computer monitors use different methods of producing color. Monitors display colors by light pixels using an RGB (red, green, blue) color process, but printers print colors using a CMYK (black, yellow, cyan, and magenta) process.

The following factors can influence your ability to match printed colors to those on your screen:

- Print media
- Printer colorants (inks or toners, for example)
- Printing process (inkjet, press, or laser technology, for example)
- Overhead lighting
- Programs
- Printer drivers
- Computer operating system
- Monitors
- Video cards and drivers
- Operating environment (very humid or very dry)
- Personal differences in perception of color

Keep these factors in mind if colors on your screen do not perfectly match your printed colors. For most users, the best method for matching colors on your screen to your printer is to print sRGB colors. The printer uses sRGB and automatically optimizes color output.

You can use HP ToolboxFX to print a palette of the MicroSoft Office Basic Colors. The palette can be used to select the final color you want to use in your printed document.

1. In HP ToolboxFX, select the **Help** folder.
2. In the **Print Quality Troubleshooting** section, select **Print Basic Colors**.

This palette shows the actual printed color that you will get when you select the basic color in your Microsoft Office application.

For more information about solving issues that are related to color output, see [Solving issues with color documents](#).





# 7 Photo



---

**NOTE** This section applies only to the HP Color LaserJet 2605dtn printer.

---

Use the following instructions to perform photo-related tasks:

- [Inserting a memory card](#)
- [Changing memory card default settings](#)
- [Changing memory card settings for the current job](#)
- [Printing photos directly from the memory card](#)
- [Printing a memory card index](#)

## Inserting a memory card

The HP Color LaserJet 2605dtn printer can read the following memory-card types:

- CompactFlash
- Memory Stick and Memory Stick PRO
- MultiMedia
- Secure Digital (SD)
- SmartMedia
- xD



**NOTE** The HP Color LaserJet 2605dtn memory card reader recognizes only files in .JPEG file format when printing from the printer control panel. To print other file types, you must use the software, such as HP Image Zone, provided on the CD-ROMs that came with the printer. See the software online Help for information about how to print photos from your computer. Windows operating system users also can use Windows Explorer to move other file types to their computer and then print the files from the computer.

Insert the memory card into the appropriate slot on the HP Color LaserJet 2605dtn printer. To determine in which slot your memory card needs to be inserted, see the illustration below.

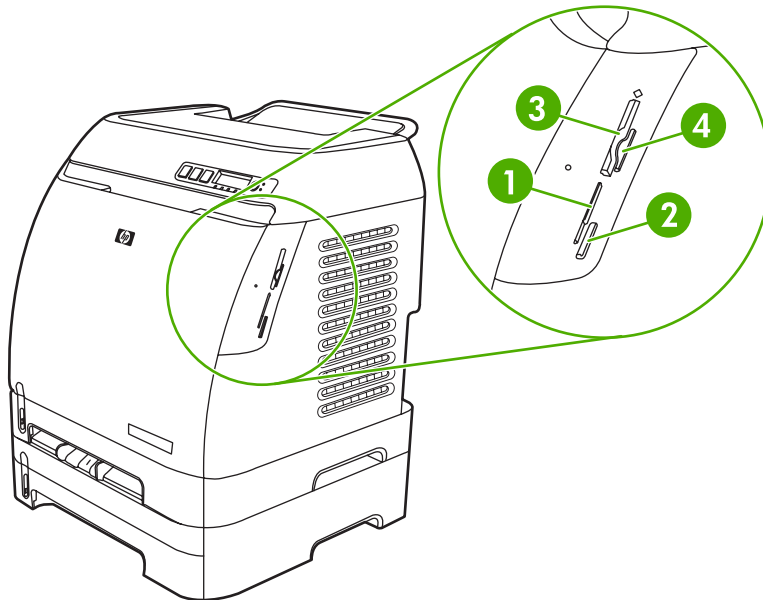

- |   |  |
|---|--|
| 1 | Accepts xD and SmartMedia memory cards.                              |
| 2 | Accepts MultiMedia, Memory Stick, and Memory Stick PRO memory cards. |
| 3 | Accepts CompactFlash memory cards.                                   |
| 4 | Accepts Secure Digital memory cards.                                 |

The printer reads the card, and then the printer control panel displays **X Photos found on card**, where *X* is the number of recognized .JPEG files found on the memory card.

Now you can use the HP Color LaserJet 2605dtn to print photos.



**NOTE** You can use only one memory card in the printer at a time. If two or more are inserted, the printer displays an error message. For more information about memory-card messages, see [Control panel messages](#).

**NOTE** The HP Color LaserJet 2605dtn recognizes memory cards up to 2 GB.











---

## Changing memory card default settings

















The HP Color LaserJet 2605dtn printer comes with default settings that were set at the factory. You can change the default settings for photo printing from the printer control panel.



**NOTE** The default settings remain as selected until you change and save them again. If you want to change the settings temporarily for a particular photo-printing job, see [Changing memory card settings for the current job](#).

1. Press  (Select).
2. Use the  (Left arrow) or  (Right arrow) button to select **Photo Setup**, and then press  (Select).
3. Use the  (Left arrow) or  (Right arrow) button to select one of the following menu items, and then press  (Select).
  - **Def. image size:** Select this item to change the size of the image that you are printing.
  - **Def. # of copies:** Select this item to change the number of copies that you want to print.
  - **Def. output color:** Select this item to set whether you are printing in color or black and white.
  - Repeat steps 1 through 3 for each menu item.
4. Use the  (Left arrow) or  (Right arrow) button to change the setting, and then press  (Select) to save the change.

# Changing memory card settings for the current job

1. Insert the memory card into the printer. The **Photo functions** menu displays.
2. Press  (**Select**) to select **Print photos** and then press  (**Select**).
3. Use the  (**Left arrow**) or  (**Right arrow**) button to select **Job settings** and then press  (**Select**).
4. Use the  (**Left arrow**) or  (**Right arrow**) button to make selections for each of the following menu items, and then press  (**Select**).
  - **Image Size:** Change the size of the image that you are printing.
  - **Paper size:** Change the media size that you are using.
  - **Paper type:** Change the media type that you are using.
  - **Def. # of copies:** Change the number of copies that you want to print.
  - **Output color:** Set whether you are printing in color or black-and-white.
5. Press  (**Select**).
  - **All (1-X):** X represents the number of JPEG files the printer detects on the card. Selecting this option prints all of the JPEG files on the memory card. Press  (**Select**) again to confirm the print job.
  - **Individual:** Selecting this option allows you to select an individual photo to print. The photos are numbered, starting with number 1. Use the  (**Left arrow**) or  (**Right arrow**) button to increase or decrease the photo number and then press the  (**Select**) button to select the photo to print.
  - **From a range:** Selecting this option allows you to select a range of photos to print. The printer prompts you for the first photo number and the last photo number. Use the  (**Left arrow**) or  (**Right arrow**) button to increase or decrease the photo numbers and then press the  (**Select**) button to select the range of photos to print.

















When you have finished changing the job settings, you can print your photos. See [Printing photos directly from the memory card](#).



**NOTE** The settings return to their default value after the memory card has been removed. If you want to change the settings permanently, see [Changing memory card default settings](#).

## Printing photos directly from the memory card

To print photos directly from the memory card, complete the following steps:

1. Insert the memory card into the printer. See [Inserting a memory card](#). The **Photo functions** menu displays.
2. Use the  (Left arrow) or  (Right arrow) button to select **Print photos** and then press  (Select).
3. Use the  (Left arrow) or  (Right arrow) button to select **Select Photos** and then press  (Select).
4. Use the  (Left arrow) or  (Right arrow) button to select one of the following menu items, and then press  (Select).
  - **All (1-X)**: X represents the number of JPEG files the printer detects on the card. Selecting this option prints all of the JPEG files on the memory card. Press  (Select) again to confirm the print job.
  - **Individual**: Selecting this option allows you to select an individual photo to print. The photos are numbered, starting with number 1. Use the  (Left arrow) or  (Right arrow) button to increase or decrease the photo number and then press the  (Select) button to select the photo to print.
  - **From a range**: Selecting this option allows you to select a range of photos to print. The printer prompts you for the first photo number and the last photo number. Use the  (Left arrow) or  (Right arrow) button to increase or decrease the photo numbers and then press the  (Select) button to select the range of photos to print.
5. Press the  (Select) button again to print the photos.









---

**NOTE** JPEG files on the memory card are numbered in alphabetical order. If you do not know the order of the photos on the memory card, you can print an index that shows the photo order. For more information about printing an index, see [Printing a memory card index](#).

---

## Printing a memory card index

1. Insert the memory card into the printer. See [Inserting a memory card](#). The **Photo functions** menu displays.
2. Use the  (Left arrow) or  (Right arrow) button to select **Index print** and then press  (Select).
3. Use the  (Left arrow) or  (Right arrow) button to select either **Best** or **Fast**, and then press  (Select).
4. Press  (Select) again to confirm the print job.

The printer prints an index that includes small preview images for each photo on the memory card. Each index page can contain as many as 30 preview images.





# 8 Networking

This section provides information about using your printer on a network.

- [Set up the printer and use it on the network](#)
- [Managing the network](#)
- [Using the printer control panel](#)
- [Supported network protocols](#)
- [TCP/IP](#)
- [Troubleshooting](#)



---

**NOTE** Configuring TCP/IP settings are complicated and should only be performed by experienced network administrators. BOOTP will require a (PC, Unix, Linux, and so on) server to configure specific TCP/IP settings for the product. DHCP will also require a server, but the TCP/IP settings will not be fixed for the printer. Finally, the manual method to configure specific TCP/IP settings can be done from the control panel or the embedded Web server. For additional help or network configuration, contact your network provider.

---

## Set up the printer and use it on the network

Hewlett-Packard recommends that you use the HP software installer on the CD-ROMs that came with the printer to set up printer drivers for the following network setups.

### To configure a network port-connected printer configuration (direct mode or peer-to-peer printing)

In this configuration, the printer is connected directly to the network, and all computers on the network print directly to the printer.



---

**NOTE** This mode is the recommended network configuration for the printer.

---

1. Connect the printer directly to the network by inserting a network cable into the printer network port.
2. At the printer, use the control panel to print a Configuration page.
3. Insert the printer CD-ROM into your computer. If you have already set up your printer, click **Install Software** to start the software installer. If the software installer does not start, navigate to the hpzsetup.exe file on the CD-ROM and double-click the file.
4. Click **Install HP Color LaserJet Software**.
5. On the **Welcome** screen, click **Next**.
6. On the **Installer updates** screen, click **Yes** to search for installer updates on the Web.
7. For Windows 2000/XP/Server 2003, on the **Installation Options** screen, choose the installation option. Hewlett-Packard recommends a typical installation, if your system supports it.
8. On the **License Agreement** screen, read the license agreement, indicate that you accept the terms, and then click **Next**.
9. For Windows 2000/XP, on the **HP Extended Capabilities** screen, choose whether you want this feature, and then click **Next**.
10. On the **Destination Folder** screen, choose the destination folder, and then click **Next**.
11. On the **Ready to Install** screen, click **Next** to begin installation.



---

**NOTE** If you want to change your settings, instead of clicking **Next**, click **Back** to return to previous screens, and then change the settings.

---

12. On the **Connection Type** screen, select **Through the network**, and then click **Next**.
13. On the **Identify Printer** screen, identify the printer either by searching or by specifying a hardware or IP address, which is listed on the Configuration page you printed earlier. Click **Next**.
14. Allow the installation process to complete.

## To configure a direct-connected shared printer (client server printing)

In this configuration, the printer is connected to a computer through a USB cable, the computer is connected to the network, and the printer is shared with other computers on the network.

1. Insert the printer CD-ROM into your computer. If you have already set up your printer, click **Install Software** to start the software installer. If the software installer does not start, navigate to the hpsetup.exe file on the CD-ROM and double-click the file.
2. Click **Install HP Color LaserJet Software**.
3. On the **Welcome** screen, click **Next**.
4. On the **Installer updates** screen, click **Yes** to search for installer updates on the Web.
5. For Windows 2000, on the **Installation Options** screen, choose the installation option. Hewlett-Packard recommends a typical installation, if your system supports it.
6. On the **License Agreement** screen, read the license agreement, indicate that you accept the terms, and then click **Next**.
7. For Windows 2000, on the **HP Extended Capabilities** screen, choose whether you want this feature, and then click **Next**.
8. On the **Destination Folder** screen, choose the destination folder, and then click **Next**.
9. On the **Ready to Install** screen, click **Next** to begin installation.



---

**NOTE** If you want to change your settings, instead of clicking **Next**, click **Back** to return to previous screens, and then change the settings.

---

10. On the **Connection Type** screen, select **Directly to this computer**, and then click **Next**.
11. Connect the USB cable.
12. Allow the installation process to complete.
13. On the Windows taskbar, click **Start**, click **Settings**, and then click **Printers**.
  - In Windows XP, click **Start**, click **Control Panel**, and then double-click **Printers and Faxes**.
14. In the dialog box, right-click the printer, and then click **Sharing**.
15. Select **Share this printer**, type the printer name if necessary, and then click **OK**.

## To change from a direct-connected shared printer to a network port-connected printer configuration

To change from a direct connection to a network configuration, complete the following steps.

1. Uninstall the printer driver for the direct connect printer.
2. Install the driver as a network configuration by using the steps in [To configure a network port-connected printer configuration \(direct mode or peer-to-peer printing\)](#).

# Managing the network

## Viewing network settings

You can use the embedded Web server or HP ToolboxFX to view your IP configuration settings. For more information, see [HP ToolboxFX](#) or [Using the embedded Web server](#).

## Changing network settings

You can use the embedded Web server or HP ToolboxFX to change your IP configuration settings. For more information, see [HP ToolboxFX](#) or [Using the embedded Web server](#).

## Set my network password

Use HP ToolboxFX to set a network password.

1. Open HP ToolboxFX and click **Device Settings**.
2. Click the **Network Settings** tab.



---

**NOTE** If a password has been set for the printer previously, you will be prompted to type the password. Type the password, and then click **Apply**.

---







3. Click **Password**.
4. In the **Password** box, type the password you want to set, and then in the **Confirm password** box, type the same password again to confirm your choice.
5. Click **Apply** to save the password.

# Using the printer control panel

The HP Color LaserJet 2605 series allows you to set up an IP address automatically using BOOTP or DHCP. For more information, see [Default IP address configuration \(AutoIP\)](#).







## Network configuration page

The Network configuration page lists the current settings and properties of the printer. To print the Network configuration page from the printer, complete the following steps.

1. On the control panel menu, press  (Select).
2. Use the  (Left arrow) or  (Right arrow) button to select **Reports**, and then press  (Select).
3. Use the  (Left arrow) or  (Right arrow) button to select **Network report**, and then press  (Select).

## Configuration page

The Configuration page lists the current settings and properties of the printer. You can print a Configuration page from the printer or HP ToolboxFX. To print the Configuration page from the printer, complete the following steps.













1. On the control panel menu, press  (Select).
2. Use the  (Left arrow) or  (Right arrow) button to select **Reports**, and then press  (Select).
3. Use the  (Left arrow) or  (Right arrow) button to select **Config report**, and then press  (Select).













## IP configuration

You can configure the IP address manually or automatically.











### Configure a static IP address for my printer

Use the following steps to manually configure a static IP address from the control panel.

1. Press  (Left arrow) or  (Right arrow) to select the **Network config** menu.
2. Press  (Select).
3. Press  (Left arrow) or  (Right arrow) to select the **TCP/IP** menu.
4. Press  (Select).
5. Press  (Left arrow) or  (Right arrow) to select **Manual**.
6. Press  (Select).
7. Press  (Left arrow) or  (Right arrow) to enter the first three digits of the IP address.
8. Press  (Select) to save those digits and move to the next three digits of the IP address.

9. Press  (Left arrow) or  (Right arrow) to enter the next three digits of the IP address.
10. Press  (Select) to save those digits and move to the next three digits of the IP address.
11. Press  (Left arrow) or  (Right arrow) to enter the next three digits of the IP address.
12. Press  (Select) to save those digits and move to the next three digits of the IP address.
13. Press  (Left arrow) or  (Right arrow) to enter the next three digits of the IP address.
14. Press  (Select).
15. The control panel will display **Yes**. Press  (Select) to save the configuration, or to delete and re-enter another IP address, press  (Left arrow) or  (Right arrow), which will change the display to **No**.
16. After selecting the IP address, you will be prompted to enter the subnet mask and default gateway using steps 7-14 above.
17. If at any time during the configuration you press  (Cancel Job), the system will exit the menu and the addresses will not be saved.

## Automatic configuration

1. On the control panel menu, press  (Select).
2. Use the  (Left arrow) or  (Right arrow) button to select **Network config.**, and then press  (Select).
3. Use the  (Left arrow) or  (Right arrow) button to select **TCPIP config**, and then press  (Select).
4. Use the  (Left arrow) or  (Right arrow) button to select **Automatic**, and then press  (Select).

It may take several minutes before the automatic IP address is ready for use.









**NOTE** If you want to disable or enable specific automatic IP modes (such as BOOTP, DHCP, or AutoIP), these settings can be changed by using the embedded Web server or HP ToolboxFX only.

## Link speed and duplex settings



**NOTE** Incorrect changes to the link speed and duplex settings might prevent the printer from communicating with other network devices. For most situations, the printer should be left in automatic mode. Also note that changes will cause the printer to power cycle. Changes should only be made while the printer is idle.

1. On the control panel menu, press  (Select).
2. Use the  (Left arrow) or  (Right arrow) button to select **Network config.**, and then press  (Select).

3. Use the  (Left arrow) or  (Right arrow) button to select **Link Speed**, and then press  (Select).

4. Use the  (Left arrow) or  (Right arrow) button to select one of the following settings.

- 10T Full
- 10T Half
- 100T Full
- 100T Half



---

**NOTE** The setting must match with the network device to which you are connecting (a network hub, switch, gateway, router, or computer).

---

5. Press  (Select). The printer will power cycle.

## Supported network protocols

The HP Color LaserJet 2605 series supports the TCP/IP network protocol. It is the most widely used and accepted networking protocol. Many networking services utilize this protocol. The following table lists the networking services/protocols that are supported on the HP Color LaserJet 2605 series.

The following operating systems support network printing:

- Windows 98 SE
- Windows Me
- Windows 2000
- Windows XP
- Macintosh OS X v10.2 and later. For more information, see [Software for Macintosh](#).

**Table 8-1** Printing

Service name	Description
port9100 (Direct Mode)	Printing service
Line printer daemon (LPD)	Printing service

**Table 8-2** Network device discovery

Service name	Description
SLP (Service Location Protocol)	Device Discovery Protocol, used to help find and configure network devices. Used primarily by Microsoft based applications.
mDNS (multicast Domain Name Service - commonly referred to as Rendezvous or Bonjour)	Device Discovery Protocol, used to help find and configure network devices. Used primarily by Apple Macintosh based Applications. For more information, see <a href="#">Software for Macintosh</a> .

**Table 8-3** Messaging and management

Service name	Description
HTTP (Hyper Text Transfer Protocol)	Allows web browsers to communicate with embedded Web server.
EWS (embedded Web server)	Allows a user to manage the device through a web browser.
SNMP (Simple Network Management Protocol)	Used by network applications for device management. SNMP v1 and standard MIB-II (Management Information Base) objects are supported.



**Table 8-4** IP addressing

Service name	Description
DHCP (Dynamic Host Configuration Protocol)	For Automatic IP address assignment. DHCP server provides device with IP address. Generally requires no user intervention for printer to obtain IP address from a DHCP server.
BOOTP (Bootstrap Protocol)	For Automatic IP address assignment. BOOTP server provides device with IP address. Requires administrator to input devices MAC hardware address on BOOTP server in order for printer to obtain an IP address from that server. For more information, see <a href="#">Software for Macintosh</a> .
Auto IP	For Automatic IP address assignment. If neither a DHCP server nor a BOOTP server is present, this service allows the printer to generate a unique IP address.

# TCP/IP

This section is intended to provide information to help you gain a basic understanding of TCP/IP.

Similar to a common language that people use to communicate with each other, TCP/IP (Transmission Control Protocol/Internet Protocol) is a suite of protocols designed to define the way computers and other devices communicate with each other over a network.

TCP/IP is rapidly becoming the most used set of protocols. The main reason this is happening is the fact that the Internet is based on TCP/IP. If you have a network that you wish to connect to the Internet, you must be using TCP/IP to communicate.

## Internet Protocol (IP)

When information is sent across the network, the data is broken down into small packets. Each packet is sent independently of one another. Each packet is encoded with IP information, such as the IP address of the sender and receiver. IP packets can be routed over routers and gateways, devices that connect a network with other networks.

IP communications is connectionless. When IP packets are sent, there is no guarantee that they arrive at their destination in the proper sequence. That task can be performed by higher level protocols and applications thereby allowing IP communications to be efficient.

Each node or device that will communicate directly onto the network requires an IP address.

## Transmission Control Protocol (TCP)

TCP handles breaking the data into packets and recombining the packets on the receiving end by providing a connection-oriented, reliable, and guaranteed delivery service to another node on the network. When data packets are received at their destination, TCP calculates a checksum for each packet to verify the data is not corrupt. If the data in the packet has been corrupted during transmission, TCP discards the packet and requests that the packet be resent.

## User Datagram Protocol (UDP)

UDP provides similar services to TCP. However, UDP does not acknowledge data receipt and supports request/reply transactions with no added reliability or guarantee of delivery. UDP is used when acknowledgment and reliability are not required, such as during a “discovery broadcast.”

## IP address

Every host (workstation or node) on an IP network requires a unique IP address for each network interface. This address is a software address that is used to identify both the network and specific hosts located on that network. Each IP address can be divided into two separate parts: the network portion and the host portion. It is possible for a host to query a server for a dynamic IP address each time the device boots up (for example, using DHCP and BOOTP).



---

**NOTE** When assigning IP addresses, always consult the IP address administrator. Setting the wrong address can disable other equipment operating on the network or interfere with communications.

---

## IP address: network portion

Network addresses are managed by an organization in Norfolk, Virginia, recognized as InterNIC. InterNIC has been contracted by the National Science Foundation to manage the Internet addresses and domains. Network addresses are distributed to organizations that are in turn responsible for making sure all attached devices or hosts on the network are properly numbered. For more information on the network portion of an IP address, see [Default IP address configuration \(AutoIP\)](#) and [Subnets](#) in this section.

## IP address: host portion

Host addresses numerically identify specific network interfaces on an IP network. Usually a host has only one network interface; thus, only one IP address. Because no two devices can share the same number at the same time, administrators typically maintain address tables to assure correct assignment of addresses in the host network.

## IP address structure and class

An IP address is comprised of 32 bits of information and divided into 4 sections containing 1 byte each section or 4 bytes total:

xxx . xxx . xxx . xxx

For efficiency in routing, networks were broken down into three classes, so routing can begin simply by identifying the leading byte of information in the IP address. The three IP addresses that InterNIC assigns are class A, B, and C. The network class determines what each of the four IP address sections identify as shown below:

**Table 8-5** IP address class format

Class	First Address Byte xxx.	Second Address Byte xxx.	Third Address Byte xxx.	Fourth Address Byte xxx
A	Network.	Host.	Host.	Host.
B	Network.	Network.	Host.	Host.
C	Network.	Network.	Network.	Host.

As illustrated in [Table 8-6 Network class characteristics](#), each network class differs by the leading bit identifier, the address range, the number of each type available, and the maximum number of hosts each class allows.

**Table 8-6** Network class characteristics

Class	Network Class Characteristics	Address Range	Maximum Number of Networks in the Class	Maximum Hosts in the Network
A	0	0.0.0.0 to 127.255.255.255.	126.	Over 16 Million.
B	10.	128.0.0.0 to 191.255.255.255.	16,382.	65,534.
C	110.	192.0.0.0 to 223.255.255.255.	Over 2 Million.	254.

## Configuring IP parameters

TCP/IP configuration parameters (such as IP address, subnet mask, default gateway) can be configured on the printer in a variety of ways. These values can be configured manually (for example, through Telnet, the embedded Web server, the arp and ping commands, and HP management software), or they can be automatically downloaded using DHCP or BOOTP each time the printer is turned on.

When powered on, a new printer that is unable to retrieve a valid IP address from the network will automatically assign itself a default IP address. The default IP address will depend on the type of network to which the printer is connected. On a small private network, a technique called link-local addressing is used to assign a unique IP address in the range of 169.254.1.0 to 169.254.254.255, which should be valid. On a large or enterprise network, a temporary address of 192.0.0.192 will be assigned until it is properly configured for your network. The IP address configured on your printer may be determined by inspecting the printer Configuration page.

### Dynamic Host Configuration Protocol (DHCP)

DHCP allows a group of devices to use a set of IP addresses that are maintained by a DHCP server. The device or host sends a request to the server, and if an IP address is available, the server assigns it to that device.

### BOOTP

BOOTP is a bootstrap protocol used to download configuration parameters and host information from a network server. BOOTP uses UDP for its transport. In order for devices to boot and load configuration information into RAM, they must communicate through the bootstrap protocol BOOTP as a client with their server.

To configure the device, the client broadcasts a boot request packet containing at least the hardware address of the device (printer hardware address). The server answers with a boot reply packet containing the information the device needs to configure.

## Subnets

When an IP network address for a particular network class is assigned to an organization, no provision is made for more than one network being present at that location. Local network administrators use subnets to partition a network into several different subnetworks. Splitting a network into subnets can result in better performance and improved use of limited network address space.

### Subnet mask

The subnet mask is a mechanism used to divide a single IP network into several different subnetworks. For a given network class, a portion of an IP address that would normally be used to identify a node is used, instead, to identify a subnetwork. A subnet mask is applied to each IP address to specify the portion used for subnetworks, and the portion used to identify the node. For example, see [Table 8-7 Example: Subnet mask 255.255.0.0 applied to class A network](#).

**Table 8-7** Example: Subnet mask 255.255.0.0 applied to class A network

Class A Network Address	Network 15	xxx	xxx	xxx
Subnet Mask	255	255	0	0

**Table 8-7** Example: Subnet mask 255.255.0.0 applied to class A network (continued)

Class A Network Address	Network 15	xxx	xxx	xxx
IP Address fields with Subnet Mask applied	Network	Subnet	Host	Host
Example of a node's IP Address on Subnet 1	15	1	25	7
Example of a node's IP Address on Subnet 254	15	254	64	2

As illustrated in [Table 8-7 Example: Subnet mask 255.255.0.0 applied to class A network](#), the Class A IP network address “15” has been assigned to company ABC. To allow additional networks at company ABC’s site, the subnet mask of 255.255.0.0 is used. This subnet mask specifies that the second byte of the IP address will be used to identify up to 254 subnets. Using this designation, each device is uniquely identified on its own subnet, but company ABC can incorporate up to 254 subnetworks without violating their assigned address space.

## Gateways

Gateways (routers) are used to connect networks together. Gateways are devices that act as translators between systems that do not use the same communication protocols, data formatting, structures, languages, or architectures. Gateways repackage the data packets and change the syntax to match that of the destination system. When networks are divided into subnets, gateways are required to connect one subnet to another.

### Default gateway

The default gateway is the gateway or router that, if not specified, will be used to move packets between networks. It is specified by an IP address.

If multiple gateways or routers exist, then the default gateway is typically the address of the first, or nearest, gateway or router. If no gateways or routers exist, then the default gateway will typically assume the IP address of the network node (such as the workstation or printer).

## TCP/IP configuration

To operate properly on a TCP/IP network, the printer must be configured with valid TCP/IP network configuration parameters, such as an IP address that is valid for your network.



**CAUTION** Changes to these settings might result in a loss of functionality with your printer. For example, HP Web JetAdmin might stop working with certain settings changes.

### Server-based, AutoIP, and manual TCP/IP configuration

When in a factory-default state and powered on, the printer will first try to obtain its TCP/IP configuration using a server-based method, such as BOOTP or DHCP. If the server-based method fails, the printer will then be configured using the AutoIP protocol. The printer may also be configured manually. Manual-based tools include a Web browser, the printer control panel, or the HP ToolboxFX utility. TCP/IP configuration values assigned manually will be retained when the printer is powered off/on. The printer can also be reconfigured to use either server-based only (BOOTP and/or DHCP), and/or AutoIP only, or manual configuration of TCP/IP settings at any time.

## Server-based TCP/IP configuration

In its factory-default state, the printer will first try BOOTP. If this fails it will then try DHCP. If this fails, it will then obtain an IP address via AutoIP. In addition, a default IP address will not be assigned if a network cable is not attached to the printer.

## Default IP address configuration (AutoIP)

A default IP address will be assigned via the AutoIP protocol if the server based methods fail. When DHCP or BOOTP fails to obtain an IP address, the printer uses a link-local addressing technique to assign a unique IP address. Link-local addressing may be referenced as AutoIP. The IP address assigned will be in the range of 169.254.1.0 to 169.254.254.255 (commonly referenced as 169.254/16), and should be valid. However, it can be further modified for your network using supported TCP/IP configuration tools if necessary. With link-local addresses, subnetting is not used. The subnet mask will be 255.255.0.0, and cannot be changed. Link-local addresses will not route off the local link, and access to or from the Internet will not be available. The default gateway address will be the same as the link-local address. If a duplicate address is sensed, the printer will automatically reassign its address, if necessary, in accordance with standard link-local addressing methods. The IP address configured on your printer may be determined by inspecting the network configuration page for the printer. Since it may take some time for the server-based protocols to time out, the AutoIP process can be sped up by disabling the BOOTP and DHCP services on the printer. This can be done via a Web browser.

## TCP/IP configuration tools

Depending on your printer and operating system, the printer can be configured with valid TCP/IP parameters for your network in the following ways:

- Using Software—You can use the HP ToolboxFX software, or you can use the printer Embedded Web server by entering the IP address in your Web browser.
- BOOTP—You can download the data from a network-based server using BOOTP (Bootstrap Protocol) each time the printer is turned on. The BOOTP daemon, `bootpd`, must be running on a BOOTP server that is accessible by the printer.
- DHCP—You can use Dynamic Host Configuration Protocol (DHCP). This protocol is supported in HP-UX, Solaris, Red Hat Linux, SuSE Linux, Windows NT/2000/XP, NetWare and Macintosh systems. (See your network operating system manuals to verify that your server operating system supports DHCP.)



---

**NOTE** Linux and UNIX systems: For more information, see the BOOTPD man page. On HP-UX systems, a sample DHCP configuration file (`dhcptab`) may be located in the `/etc` directory. Since HP-UX presently does not provide Dynamic Domain Name Services (DDNS) for its DHCP implementations, HP recommends that you set all printer lease durations to **infinite**. This ensures that printer IP addresses remain static until such time as Dynamic Domain Name Services are provided.

---

# Troubleshooting

## Verifying that the printer is on and online

Check the following items to make sure the printer is ready to print.

1. Is the printer plugged in and turned on?  
Make sure that the printer is plugged in and turned on. If the problem persists, you might have a defective power cable, power source, or printer.
2. Is the printer Ready light on?  
If the light is blinking, you might need to wait until the current job is completed.
3. Is the printer control panel display blank?
  - Make sure the printer is turned on.
  - Make sure the printer is installed correctly.
4. Does a message other than **Ready** appear on the printer control panel display?
  - See your printer documentation for a complete list of control panel messages and corrective actions.

## Resolving communication problems with the network

Check the following items to verify that the printer is communicating with the network. This information assumes you have already printed a Network configuration page (see [Networking page](#)).

1. Are there any physical connection problems between the workstation or file server and the printer?  
Verify that the network cabling, connections, and router configurations are correct. Verify that the network cable lengths meet network specifications.
2. Are your network cables connected properly?  
Make sure that the printer is attached to the network using the appropriate port and cable. Check each cable connection to make sure it is secure and in the right place. If the problem continues, try a different cable or ports on the hub or transceiver. The amber activity light and the green link status light next to the port connection on the back of the printer should be lit.
3. Are the link speed and duplex settings set correctly?  
Hewlett-Packard recommends leaving this setting in automatic mode (the default setting). See [Link speed and duplex settings](#).
4. Can you "ping" the printer?  
Use the command prompt to ping the printer from your computer. For example:  

```
ping 192.168.45.39
```

  
Ensure that the ping displays round-trip times.

If you are able to ping the printer, verify that the IP address configuration for the printer is correct on the computer. If it is correct, delete and then add the printer again.

If the ping command failed, verify that the network hubs are on, and then verify that the network settings, the printer, and the computer are all configured for the same network.

**5.** Have any software applications been added to the network?

Make sure they are compatible and that they are installed correctly with the correct printer drivers.

**6.** Are other users able to print?

The problem may be workstation-specific. Check the workstation network drivers, printer drivers, and redirection (capture in Novell NetWare).

**7.** If other users are able to print, are they using the same network operating system?

Check your system for proper network operating system setup.

**8.** Is your protocol enabled?

Check the status of your protocol on the Network configuration page. See [Networking page](#). You can also use the embedded Web server or HP ToolboxFX to check the status of other protocols. See [HP ToolboxFX](#) or [Using the embedded Web server](#).

**9.** Does the printer appear in HP Web Jetadmin or other management application?

- Verify network settings on the Network configuration page.
- Confirm the network settings for the printer using the printer control panel (for printers with control panels).



# 9 How do I?

Use this section to perform basic tasks with the HP Color LaserJet 2605 series printers.

- [Print: How do I?](#)
- [Network: How do I?](#)
- [Add memory: How do I?](#)
- [Other: How do I?](#)

# Print: How do I?

Use this section to answer printing questions.

## Set the printer for high-quality output

You can print on special media such as transparencies, labels, heavy paper, glossy paper, photo paper, and card stock, by using the optimizing feature in the printer driver.

1. Load the media input tray. Make sure that the top of the media is forward and the side to be printed on (the rough side of transparencies) is facing up.
2. Adjust the media guides to fit the width of the media.
3. Open a document in a program, such as Microsoft Word.
4. Select the print command. For most programs, click the **File** menu, and then click **Print**. The **Print** dialog box appears.
5. On the **Print** dialog box, click **Properties**.
6. On the **Paper** or **Quality** tab, select one of these media types:
  - **Plain**
  - **Preprinted**
  - **Letterhead**
  - **Transparency**
  - **Prepunched**
  - **Labels**
  - **Bond**
  - **Recycled**
  - **Color**
  - **HP Tough paper**
  - **Envelope**
  - **Light 60-74 g/m<sup>2</sup>**
  - **Heavy paper 91-105 g/m<sup>2</sup>**
  - **Cardstock 106-176 g/m<sup>2</sup>**
  - **Light Glossy 75-105 g/m<sup>2</sup>**
  - **Glossy 106-120 g/m<sup>2</sup>**
  - **Heavy Glossy 121-163 g/m<sup>2</sup>**

- **HP Premium Cover** 200 g/m<sup>2</sup>
  - **HP Premium Plus Photo** 220 g/m<sup>2</sup>
7. Print the document. Remove the media from the printer as it prints to prevent it from sticking together, and place the printed pages on a flat surface.

The media type can also be selected and configured in HP ToolboxFX. To configure these media types from HP ToolboxFX, click **Device Settings**, click the **System Settings** tab, and then open the **Print Modes** page. Make any necessary changes, and then click **Apply** to save the changes.

To print a single-page cover letter on letterhead, followed by a multiple-page document, load a single sheet of letterhead in Tray 1. After the letterhead page has printed, the printer prompts you to load paper. Load paper for the rest of the document.

## Print on both sides of the paper

To print on both sides of the paper, you have to return to the printer and reinsert the paper manually after the first side has printed.



---

**CAUTION** Do not print on both sides of labels or transparencies. Damage to the printer and jams might result.

---

### To print on both sides (manually)

1. Insert enough paper into Tray 2 or optional Tray 3 to accommodate the print job.

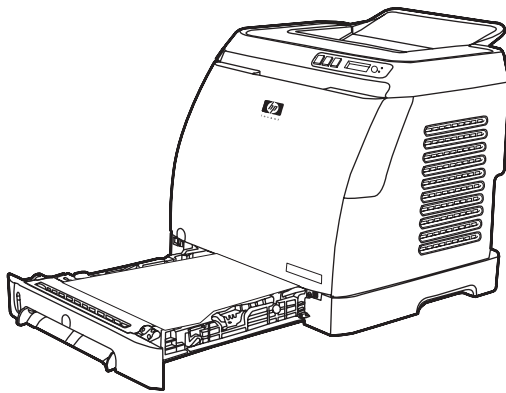

---

**NOTE** In Windows, **Print on both sides (manually)** must be enabled to complete these instructions. To enable duplexing, in the printer driver, select **Properties**, and then click on the **Configure** tab. Under Paper handling, select **Allow Manual Duplexing**, and then click **OK** to save.

---

2. Use the following procedure to configure the printer to Print on both sides (manually).

In the printer driver, select the **Finishing** tab, select the **Print on both sides (manually)** option, and then send the job to print.

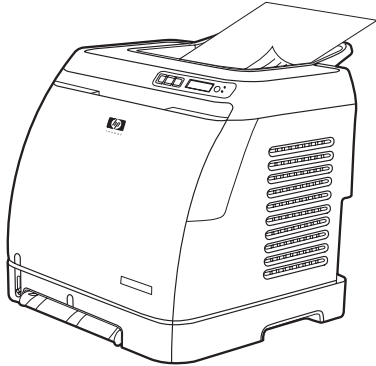

3. After the job is finished printing, remove any blank paper as prompted by the control panel. Lift the printed stack from the output bin and insert the printed stack without rotating or turning the stack over into the printer tray that was used for the first part of the job.

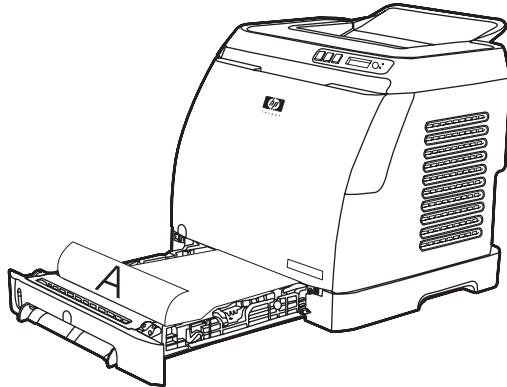

4. Press  (Select) to continue printing on the second side.

### To print on both sides (automatically)

Perform the following steps to print on both sides (automatically). To check for supported media for 2-sided printing, see [Print-media specifications](#).

1. Verify that the printer driver is configured for 2-sided printing. For instructions, see the online help for the printer driver.
2. Select the appropriate 2-sided printing options in the printer driver software, including page and binding orientation.



**NOTE** When using 2-sided printing, load pre-printed forms and letterhead into Tray 1 face-up with the bottom edge of the page feeding first. Load preprinted forms and letterhead into Tray 2 and Tray 3 face-down with the top edge at the back of the tray.

**NOTE** Loading pre-printed forms and letterhead is different than loading for 1-sided printing.

## Select paper type for special media

Use the guidelines in following table when printing on special media. If printing on a special type of media, printing speeds might be automatically reduced to improve the output quality for that specific media. See [Print-media specifications](#) for media that is recommended for this printer. For instruction on loading the trays, see [Loading Tray 1](#) or [Loading Tray 2](#).

**Table 9-1** Special media printing guidelines

Paper type	Maximum amount that can be loaded into Tray 2 or optional Tray 3	Paper quality, type	Tray 1 paper orientation	Tray 2 or optional Tray 3 paper orientation
Normal	Up to 250 sheets	Plain or unspecified	Side to be printed face down	Side to be printed face up
Envelopes	Up to 10 envelopes	Envelope	Short edge leading, flap on right side facing down	Short edge leading, flap on right side facing up
Heavy envelopes	Up to 10 envelopes	Heavy envelope	Short edge leading, flap on right side facing down	Short edge leading, flap on right side facing up
Labels	Up to 25 mm (0.99 inch) stack height	Labels	Side to be printed face down	Side to be printed face up
Transparencies	Up to 50 sheets	Transparencies	Side to be printed face down	Side to be printed face up
Glossy	Up to 25 mm (0.99 inch) stack height	Light glossy, glossy, or heavy glossy	Side to be printed face down	Side to be printed face up
Letterhead	Up to 250 sheets	Letterhead	Side to be printed face down, printed edge at front of tray	Side to be printed face up, printed edge at front of tray
Cardstock	Up to 25 mm (0.99 inch) stack height	Cardstock or heavy	Side to be printed face down	Side to be printed face up

## Change the device print settings, such as print quality, in HP ToolboxFX

To change the default print settings in HP ToolboxFX, complete the following steps.



**NOTE** The changes that you make to the print settings in HP ToolboxFX apply to all future print jobs.

1. Open HP ToolboxFX and click **Device Settings**.
2. Click the **Settings** tab.
3. On the **Settings** tab, you can modify settings that appear on the following pages.
  - **Paper Handling**
  - **Printing**
  - **Print Quality**

- **Print Density**
- **Paper type settings**
- **Print Modes**
- **System Setup**
- **Service**

4. Click **Apply** to save the changes that you make on these pages.



**NOTE** If you have similar settings in the printer driver, those settings take priority over the settings that are established in HP ToolboxFX.

## Print color documents from my computer in black and white only

In the software program, select **File, Print**, the **HP Color LaserJet 2605** or **HP Color LaserJet 2605\_dtn PCL6** print driver, click **Properties**, click the **Color** tab, and then select the **Print in Grayscale** check box. Click **OK** to save the print properties, and then click **OK** again to print the document.

## Change color options

Use the Manual color adjustment to adjust the **Color** (or **Color Map**) options.



**NOTE** Some software programs convert text or graphics to raster images. In these cases, the **Photographs** setting also controls the text and graphics.

## Halftone options

Halftoning is the method by which the printer mixes the four primary colors (cyan, magenta, yellow, and black) in varying proportions to create millions of colors. Halftone options affect the resolution and clarity of your color output. The two halftone options are **Smooth** and **Detail**.

- The **Smooth** option provides better results for large, solid-filled print areas. It also enhances photos by smoothing out fine color gradations. Choose this option when uniform and smooth area fills are the most important attributes.
- The **Detail** option is useful for text and graphics that require sharp distinctions among lines or colors, or images that contain a pattern or a high level of detail. Choose this option when sharp edges and details are the most important attributes.

## Edge Control

The **Edge Control** setting determines how edges are rendered. Edge Control consists of two components: Adaptive Halftoning and Trapping. Adaptive Halftoning increases the edge sharpness. Trapping reduces the effect of color-plane misregistration by slightly overlapping the edges of adjacent objects. The following levels of edge control are available:

- **Off** sets Trapping and Adaptive Halftoning to Off.
- **Normal** provides the default trapping settings. Adaptive Halftoning is set to On.
- **Maximum** provides the most trapping. Adaptive Halftoning is set to On.

## RGB Color

The **RGB Color** option determines how colors are rendered.

- Select **Default (sRGB)** for most printing needs. This setting instructs the printer to interpret RGB color as sRGB, which is the accepted standard of Microsoft and the World Wide Web Organization.
- Select **AdobeRGB** for documents that use the AdobeRGB color space rather than sRGB. For example, some digital cameras capture images in AdobeRGB, and documents that are produced with Adobe PhotoShop use the AdobeRGB color space. When printing from a professional software program that uses AdobeRGB, it is important that you turn off the color management in the software program and allow the printer software to manage the color space.
- **Photo Image** interprets the RGB color as if it were printed as a photograph using a digital mini-lab. It is designed to render the deeper, more saturated colors differently than Default mode. Use this setting for printing photos.
- **Device** sets the printer to print RGB data in raw device mode. To render photographs properly when this option is selected, you must manage color in the program in which you are working or in the operating system.
- **Vivid** instructs the printer to increase the color saturation in the midtones. Less colorful objects are rendered more colorfully. This value is recommended for printing business graphics.

## Neutral Grays

The **Neutral Grays** setting determines the method for creating gray colors that are used in text, graphics, and photographs.

- **Black Only** generates neutral colors (grays and black) by using only black toner. This option guarantees that neutral colors do not have a color cast.
- **4-Color** generates neutral colors by combining all four colors of toner. This option produces smoother gradients and transitions to non-neutral colors. It also produces the darkest possible black.

## Network: How do I?

Use this section to answer network questions.

### Set up the printer and use it on the network

Hewlett-Packard recommends that you use the HP software installer on the CD-ROMs that came with the printer to set up printer drivers for the following network setups.

#### Set my network password

Use HP ToolboxFX to set a network password.

1. Open HP ToolboxFX and click **Device Settings**.
2. Click the **Network Settings** tab.



---

**NOTE** If a password has been set for the printer previously, you will be prompted to type the password. Type the password, and then click **Apply**.

---

3. Click **Password**.
4. In the **Password** box, type the password you want to set, and then in the **Confirm password** box, type the same password again to confirm your choice.
5. Click **Apply** to save the password.

#### Find my network IP address

The network IP address is located on the Configuration page. Use the following steps to print a Configuration page from the control panel.

















1. Press  (Left arrow) or  (Right arrow) to select the **Reports** menu.
2. Press  (Select).
3. Press  (Left arrow) or  (Right arrow) to select **Config Report**.
4. Press  (Select) to print the Configuration Report page.

#### Configure a static IP address for my printer

Use the following steps to manually configure a static IP address from the control panel.

1. Press  (Left arrow) or  (Right arrow) to select the **Network config** menu.
2. Press  (Select).
3. Press  (Left arrow) or  (Right arrow) to select the **TCP/IP** menu.
4. Press  (Select).
5. Press  (Left arrow) or  (Right arrow) to select **Manual**.
6. Press  (Select).



7. Press  (Left arrow) or  (Right arrow) to enter the first three digits of the IP address.
8. Press  (Select) to save those digits and move to the next three digits of the IP address.
9. Press  (Left arrow) or  (Right arrow) to enter the next three digits of the IP address.
10. Press  (Select) to save those digits and move to the next three digits of the IP address.
11. Press  (Left arrow) or  (Right arrow) to enter the next three digits of the IP address.
12. Press  (Select) to save those digits and move to the next three digits of the IP address.
13. Press  (Left arrow) or  (Right arrow) to enter the next three digits of the IP address.
14. Press  (Select).
15. The control panel will display **Yes**. Press  (Select) to save the configuration, or to delete and re-enter another IP address, press  (Left arrow) or  (Right arrow), which will change the display to **No**.
16. After selecting the IP address, you will be prompted to enter the subnet mask and default gateway using steps 7-14 above.
17. If at any time during the configuration you press  (Cancel Job), the system will exit the menu and the addresses will not be saved.



## Add memory: How do I?

Use this section to answer questions about adding memory.

### Installing memory and font DIMMs

You can install more memory for the printer, and you can also install a font DIMM to print characters for languages such as Chinese, or for the Cyrillic alphabet.

**CAUTION** Static electricity can damage DIMMs. When handling DIMMs, wear an antistatic wrist strap, or frequently touch the surface of the DIMM antistatic package and then touch bare metal on the printer.

1. Print a Configuration page by pressing  (Select) and  (Cancel Job) simultaneously. (A Supplies Status page and possibly an HP Jetdirect Configuration page also print.) If the Configuration page does not print in your language, see [Device pages and reports](#).
2. After the Configuration page prints, turn the printer off and disconnect the power cable.

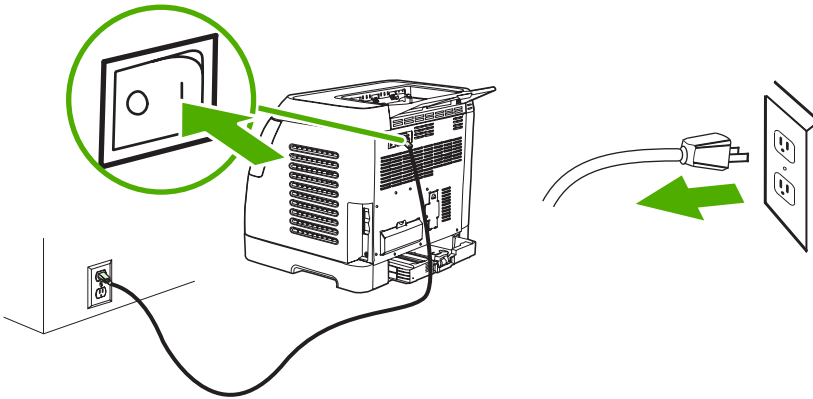

3. On the left rear side of the printer, open the DIMM door.

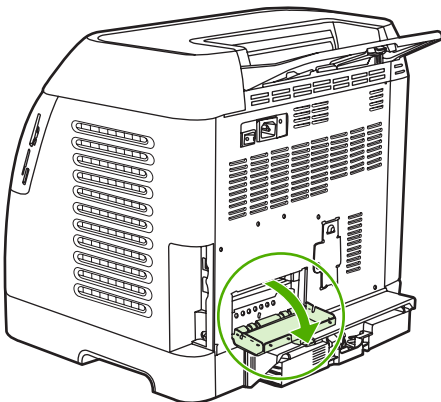

4. Release the locks on each side of the DIMM slot.

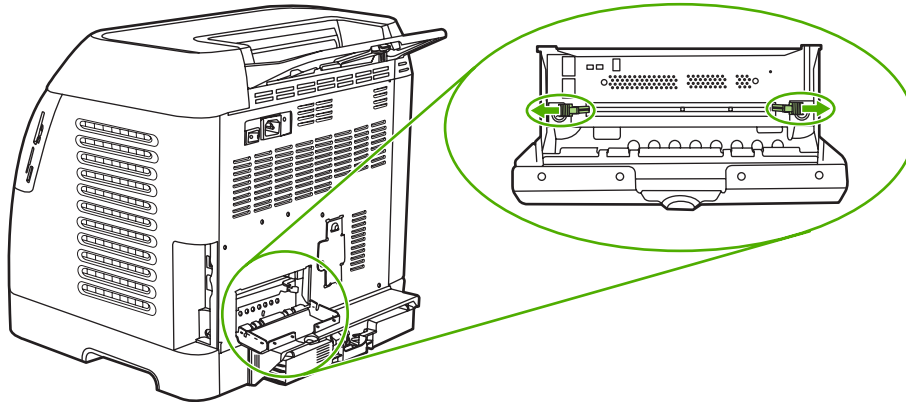

5. Remove the DIMM from the antistatic package.

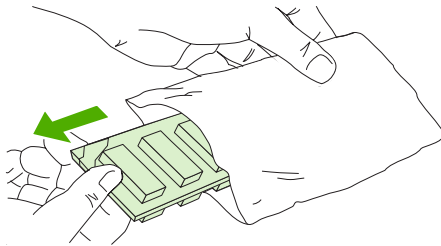

6. Holding the DIMM by the edges as shown in the illustration, align the notches on the DIMM with the DIMM slot.

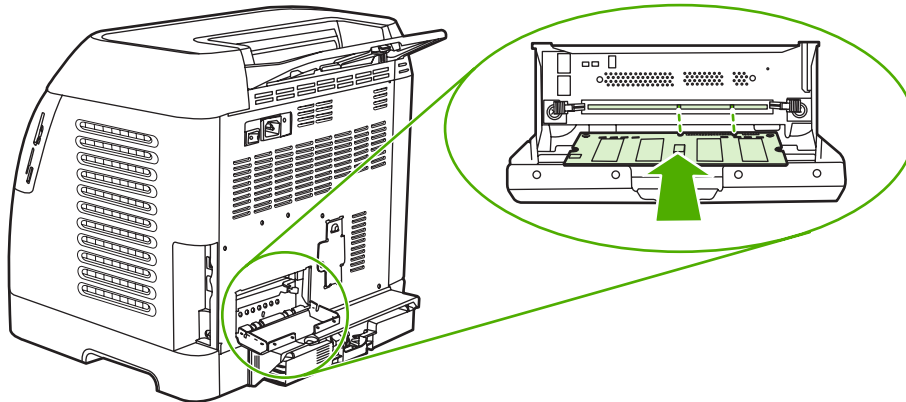

7. Firmly press the DIMM straight into the slot. Firmly close the locks on each side of the DIMM until they snap into place.

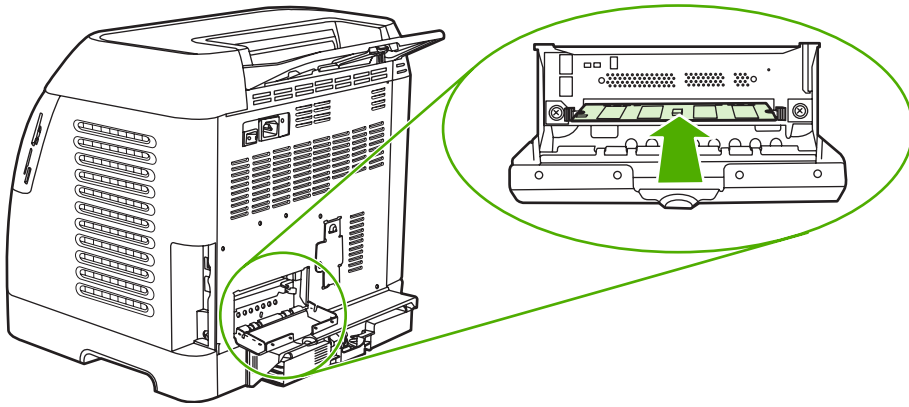

8. Close the DIMM door.

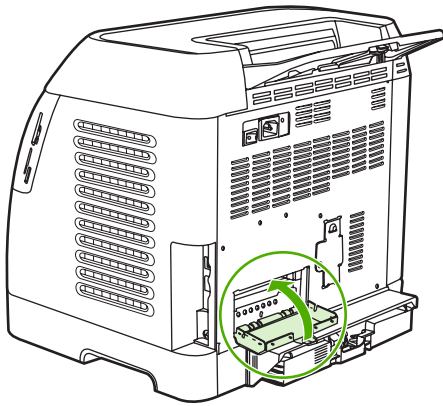

9. Reconnect the power cable and turn the printer on.

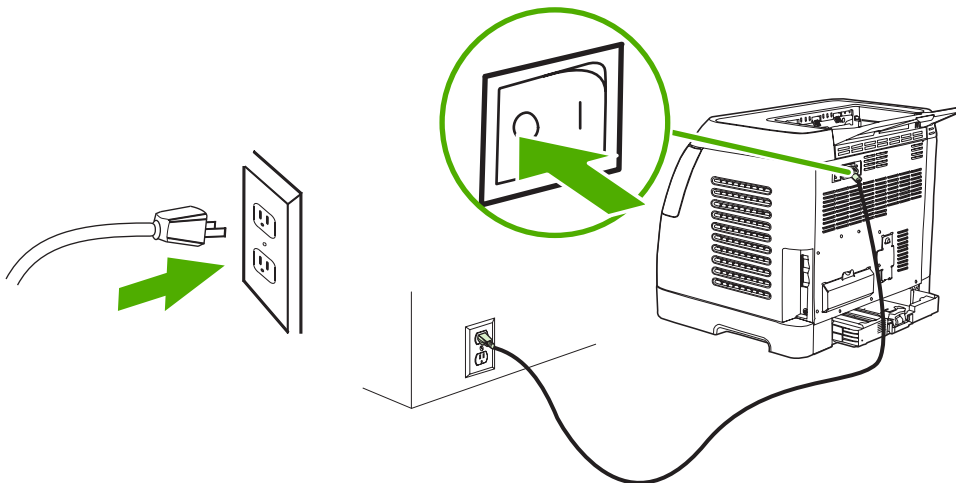

10. Go to [Checking DIMM installation](#).

## Other: How do I?

Use this section to answer other questions about the printer.

### Changing print cartridges

When a print cartridge approaches the end of useful life, the control panel displays a message recommending that you order a replacement. The printer can continue to print using the current print cartridge until the control panel displays a message instructing you to replace the cartridge.

The printer uses four colors and has a different print cartridge for each color: black (K), cyan (C), magenta (M), and yellow (Y).

Replace a print cartridge when the printer control panel displays one of the following messages: **Replace yellow cartridge**, **Replace magenta cartridge**, **Replace cyan cartridge**, **Replace black cartridge**. The control panel display also indicates the color that should be replaced (unless a genuine HP cartridge is not currently installed).

### To change the print cartridge

1. Open the front door.

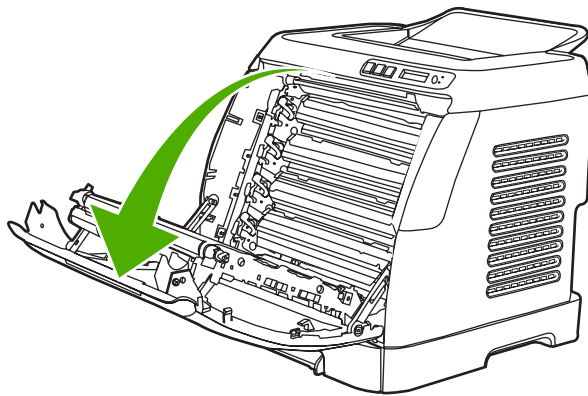

**CAUTION** Do not place anything on the transfer belt (ETB), which is located on the inside of the front door.

2. Remove the used print cartridge from the printer.

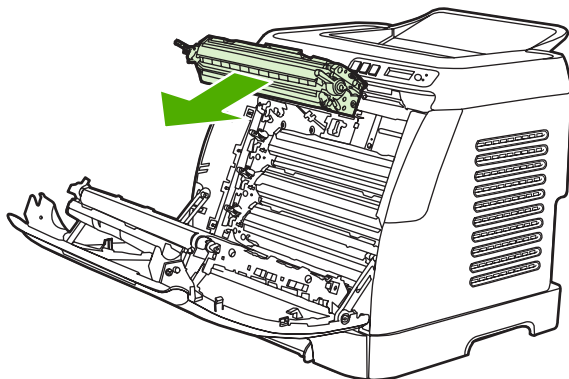

3. Remove the new print cartridge from the bag. Place the used print cartridge in the bag for recycling.

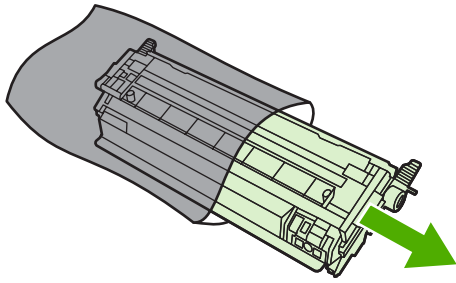

4. Grasp both sides of the print cartridge by the blue handles and distribute the toner by gently rocking the print cartridge from side to side.



**CAUTION** Do not touch the shutter or the surface of the roller.

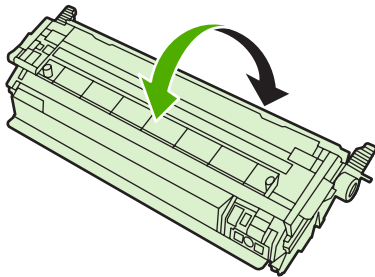

5. Remove the shipping locks and the shipping tape from the new print cartridge. Discard the shipping tape and shipping locks according to local regulations.

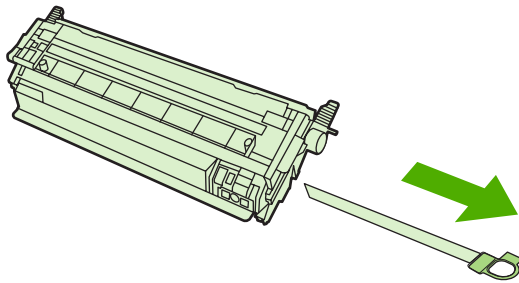

6. Align the print cartridge with the tracks inside the printer, and using the handles, insert the print cartridge until it is firmly seated.

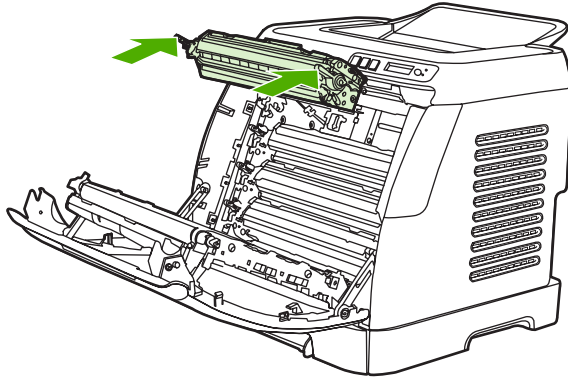

7. Firmly close the front door.

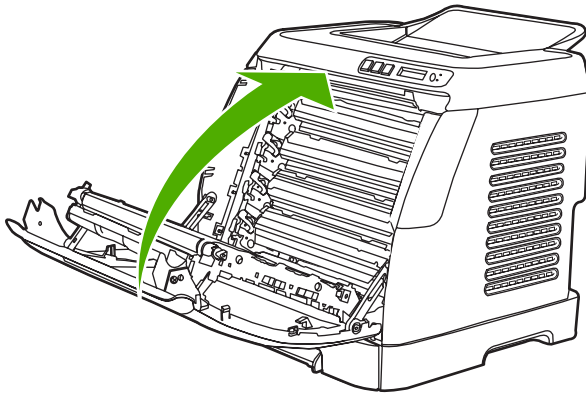

After a short time, the control panel should display **Ready**.



---

**NOTE** If a cartridge is in the wrong slot or is the wrong type for the printer, the control panel will display one of the following messages: **Incorrect yellow**, **Incorrect magenta**, **Incorrect cyan**, **Incorrect black**, or **Incorrect supplies**.

---

8. Installation is complete. Place the used print cartridge in the box in which the new cartridge arrived. See the enclosed recycling guide for recycling instructions.
9. If you are using a non-HP print cartridge, check the printer control panel for further instructions.

For additional help, go to <http://www.hp.com/support/clj2605>.



---

**NOTE** When replacing or changing a black print cartridge, a cleaning page will automatically be printed. This helps prevent speckles on the front or back of printed documents. For a more thorough cleaning, see [To clean the paper path using HP ToolboxFX](#).

---





# 10 Managing the printer

This printer comes with several software tools that help you monitor, troubleshoot problems with, and maintain the printer. Information about using these tools is in the following sections:



- [Device pages and reports](#)
- [Menu map](#)
- [HP ToolboxFX](#)
- [Using the embedded Web server](#)

## Device pages and reports

Special pages reside within the memory of the printer. These pages help you to diagnose and solve problems with the printer.

If the printer language was not correctly set during installation, you can set the language manually so that the pages print in one of the supported languages. Change the language by using the HP ToolboxFX.







### Demo page

To print the Demo page, press the  (Left arrow) or  (Right arrow) buttons on the printer control panel simultaneously. You can also print this page from the HP ToolboxFX.

### Configuration page

The Configuration page lists current settings and properties of the printer. You can print a Configuration page from the printer or the HP ToolboxFX.

#### To print the Configuration page from the control panel

1. Press  (Left arrow) or  (Right arrow) to select the **Reports** menu.
2. Press  (Select).
3. Press  (Left arrow) or  (Right arrow) to select **Config report**.
4. Press  (Select) to print the Configuration Report page.

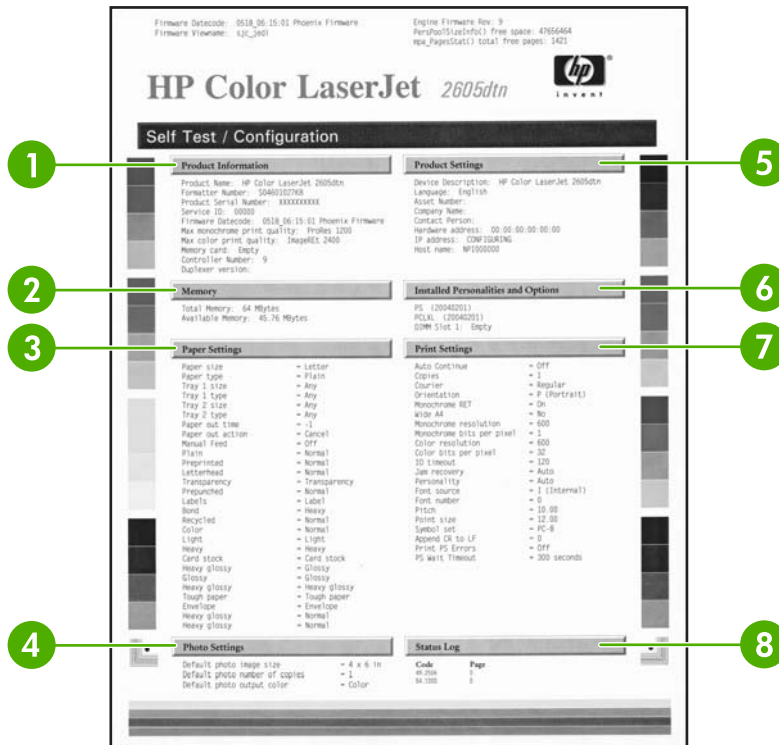







- 1. Product Information.** This section contains basic information about the printer, such as the product name and the serial number.
- 2. Memory.** This section lists memory-related information, such as the total memory that is installed.
- 3. Paper Settings.** This section lists information about the media type for each tray and about the type settings for all the media that the printer supports.
- 4. Page Counts.** This section lists the total number of pages printed, the number of color pages printed, and information about paper jams.
- 5. Product Settings.** This section lists information that is gathered during software installation, including the language and the company name.
- 6. Network Settings.** This section contains network information about the printer such as the Host Name, Hardware Address, and IP Address.
- 7. Paper Types.** This section contains information about paper types that can be configured by the user.
- 8. Status Log.** This section contains information about printer errors.

## Supplies Status page

The Supplies Status page lists the remaining life of HP print cartridges. It also lists the estimated pages remaining, number of pages printed, and other supplies information. You can print a Supplies Status page from the printer or the HP ToolboxFX.

## To print the Supplies Status page from the control panel

1. Press  (Left arrow) or  (Right arrow) to select the **Reports** menu.
2. Press  (Select).
3. Press  (Left arrow) or  (Right arrow) to select **Supplies Status**.
4. Press  (Select) to print the Supplies Status page.



**NOTE** Supplies information is also available through the HP ToolboxFX.

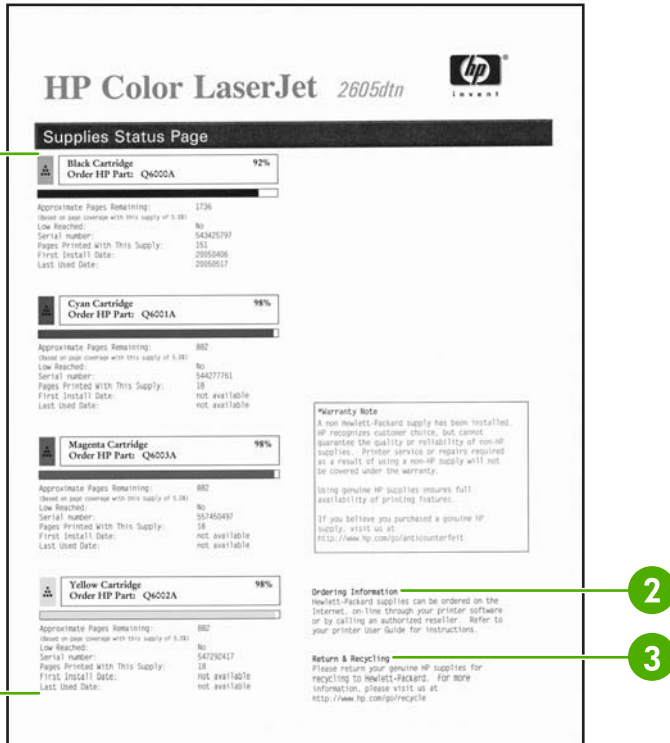

**HP Color LaserJet 2605dtn**

### Supplies Status Page

**Black Cartridge**  
Order HP Part: Q6000A 92%

Approximate Pages Remaining: 1706  
(based on page coverage with this supply of 5.00)  
Low Reached: No  
Serial number: 544262793  
Pages Printed with This Supply: 151  
First Install Date: 20050605  
Last Used Date: 20050917

**Cyan Cartridge**  
Order HP Part: Q6001A 98%

Approximate Pages Remaining: 882  
(based on page coverage with this supply of 5.00)  
Low Reached: No  
Serial number: 544277761  
Pages Printed with This Supply: 18  
First Install Date: not available  
Last Used Date: not available

**Magenta Cartridge**  
Order HP Part: Q6003A 98%

Approximate Pages Remaining: 882  
(based on page coverage with this supply of 5.00)  
Low Reached: No  
Serial number: 537450497  
Pages Printed with This Supply: 18  
First Install Date: not available  
Last Used Date: not available

**Yellow Cartridge**  
Order HP Part: Q6002A 98%

Approximate Pages Remaining: 882  
(based on page coverage with this supply of 5.00)  
Low Reached: No  
Serial number: 547292417  
Pages Printed with This Supply: 18  
First Install Date: not available  
Last Used Date: not available

**Warranty Note**  
A non Hewlett-Packard supply has been installed. HP recognizes customer choice, but cannot guarantee the quality or reliability of non-HP supplies. Printer service or repairs required as a result of using a non-HP supply will not be covered under the warranty.  
Using genuine HP supplies ensures full availability of printing features.  
If you believe you purchased a genuine HP supply, visit us at: <http://www.hp.com/go/counterfeit>







**Ordering Information**  
Hewlett-Packard supplies can be ordered on the Internet, on-line through your printer software or by calling an authorized reseller. Refer to your printer user guide for instructions.

**Return & Recycling**  
Please return your genuine HP supplies for recycling to Hewlett-Packard. For more information, please visit us at: <http://www.hp.com/go/recycle>

1. **Print cartridge area.** This area contains a section for each of the print cartridges and provides information about HP print cartridges. This information includes the part number for each print cartridge, whether each print cartridge is low, and the life remaining for each print cartridge, which is expressed as a percentage, as a graphic, and as the estimated number of pages remaining. This information might not be provided for non-HP supplies. In some cases, if a non-HP supply is installed, an alert message displays instead.
2. **Ordering Information.** This section contains basic information about how to order new HP supplies.
3. **Return & Recycling.** This section contains a link to the website that you can visit for information about recycling.







## Networking page

The Networking report option prints a Network configuration report. You can print this page using the printer control panel. Use the following steps to print the Network configuration report.

1. Press  (Left arrow) or  (Right arrow) to select the **Reports** menu.
2. Press  (Select).
3. Press  (Left arrow) or  (Right arrow) to select **Network report**.
4. Press  (Select) to print the Network configuration page.







## Fonts pages

The fonts pages provide lists of the available fonts on the printer, including PostScript (PS) fonts, PCL fonts, and PCL6 fonts (PCLXL). You can print these font pages using the printer control panel. Use the following steps to print a fonts page.

1. Press  (Left arrow) or  (Right arrow) to select the **Reports** menu.
2. Press  (Select).
3. Press  (Left arrow) or  (Right arrow) to select **PS font list**, **PCLXL font list**, or **PCL font list**.
4. Press  (Select) to print the selected fonts page.

## Usage page







The Usage Page provides information on the number and types of pages printed by the printer. You can print the usage page using the printer control panel. Use the following steps to print a usage page.

1. Press  (Left arrow) or  (Right arrow) to select the **Reports** menu.
2. Press  (Select).
3. Press  (Left arrow) or  (Right arrow) to select **Usage page**.
4. Press  (Select) to print the Usage Page.

# Menu map

The menu map lists the menu structure for each option available on the printer control panel. Use the following steps to print a menu map.

## To print a menu map

1. Press  (Left arrow) or  (Right arrow) to select the **Reports** menu.
2. Press  (Select).
3. Press  (Left arrow) or  (Right arrow) to select **Menu structure**.
4. Press  (Select) to print the Menu map.

# HP ToolboxFX

HP ToolboxFX is a Web-based program that you can use to complete the following tasks:

- Check the printer status.
- Configure the printer settings.
- View troubleshooting information.
- View online documentation.

You can view HP ToolboxFX when the printer is directly connected to your computer or when it is connected to the network. You must perform a typical software installation to use HP ToolboxFX.



---

**NOTE** HP ToolboxFX is not supported for Windows 98 SE, Windows Me, Windows Server 2003, or Macintosh operating systems.

**NOTE** You do not have to have Internet access to open and use HP ToolboxFX.

---

## To view HP ToolboxFX

Open HP ToolboxFX in one of these ways:

- In the Windows system tray or on your desktop, double-click the HP ToolboxFX icon.
- On the Windows **Start** menu, click **Programs** (or **All Programs** in Windows XP), click **HP**, click **HP Color LaserJet 2605 series** , and then click **HP ToolboxFX**.

The HP ToolboxFX software contains the following sections:

- [Status](#)
- [Alerts](#)
- [Help](#)
- [Device settings](#)
- [Network settings](#)

## Status

The HP ToolboxFX **Status** folder contains links to the following main pages:

- **Device Status.** View printer status information. This page indicates printer conditions such as a jam or an empty tray. After you correct a problem with the printer, click **Refresh** button to update the printer status.
- **Supplies Status.** View detailed supplies status such as the estimated percent of toner remaining in the print cartridge and the number of pages that have been printed with the current print cartridge. This page also has links to order supplies and to find recycling information.
- **Device Configuration.** View a detailed description of the current printer configuration, including the amount of memory installed and whether optional trays are installed.
- **Network Configuration.** View a detailed description of the current network configuration, including the IP address and network status.
- **Print Info Pages.** Print the Configuration page and various other information pages that are available for the printer, such as the Supplies Status page and the Demo page.
- **Event Log.** View a history of printer errors. The most recent error is at the top of the list.

## Event log

The Event log is a four-column table where the printer events are logged for your reference. The log contains codes that correspond to the error messages that appears on the printer control-panel display. The number in the Page Count column specifies the total number of pages that the printer had printed when the error occurred. The Event log also contains a brief description of the error. For more information about error messages, see [Control panel messages](#).



## Alerts

The HP ToolboxFX **Alerts** folder contains links to the following main pages:

- **Set up Status Alerts.** Set up the printer to send you pop-up alerts for certain events, such as low toner levels.
- **Set up E-mail Alerts.** Set up the printer to send you e-mail alert messages for certain events, such as low toner levels.

### Set up status alerts

Use HP ToolboxFX to set up the printer so that it issues pop-up alerts to your computer when certain events occur. Events that trigger alerts include jams, low levels of toner in HP print cartridges, non-HP print cartridge in use, empty input trays, and specific error messages.

Select the pop-up format, the system tray icon format, the desktop format, or all three for the alerts. The pop-up alerts only appear when the printer is printing from the computer on which you set up the alerts.



---

**NOTE** You must click **Apply** before your changes take effect.

---

### Set up e-mail alerts

Use HP ToolboxFX to configure up to two e-mail addresses to receive alerts when certain events occur. You can specify different events for each e-mail address. Enter the information for the e-mail server that will send out the e-mail alert messages for the printer.



---

**NOTE** You must click **Apply** before your changes take effect.

---

## Help

The HP ToolboxFX **Help** folder contains links to the following main pages:

- **Troubleshooting.** Print troubleshooting pages, clean the printer, and display Microsoft Office Basic Colors. For more information on Microsoft Office Basic colors, see [Matching colors](#).
- **How Do I?** View the How Do I? Help for help with specific tasks.
- **Animated demonstrations**
- **User Guide.** View information about the printer usage, warranty, specifications, and support. The user guide is available in both HTML and PDF format.
- **Readme.** View important information about the printer that is not available in the user guide. The late-breaking Readme contain last-minute information about the printer (in English only).

## Device settings

The HP ToolboxFX **Device Settings** folder contains links to the following main pages:

- **Device Information.** View information about the printer, such as the printer description and a contact person.
- **Paper handling.** Change the printer paper-handling settings, such as default paper size and default paper type.
- **Printing.** Change the default printer print settings, such as number of copies and paper orientation.
- **PCL5e.** View and change the PCL5e settings.
- **PostScript.** View and change the PS settings.
- **Print quality.** Change the printer print-quality settings.
- **Print density.** Change the print density settings, such as contrast, highlights, midtones, and shadows.
- **Paper types.** Change the printer mode settings for a each media type, such as letterhead, prepunched, or glossy paper.
- **Memory Card.** Change the printer settings, such as image size, number of copies, and output color when printing photos using memory cards.
- **System Setup.** Change the printer system settings, such as printer language and jam recovery.
- **Service.** Gain access to various procedures required to maintain the printer.
- **Save/restore settings.** Save the current settings for the printer to a file on your computer. Use this file to load the same settings onto another printer or to restore these settings to this printer at a later time.

## Device information

The HP ToolboxFX Device information + about your printer for future reference. The information that you type in these fields appears on the Configuration page. You can type any character in each of these fields.



---

**NOTE** You must click **Apply** before your changes take effect.

---

## Paper handling

Use the HP ToolboxFX paper-handling options to configure your default settings. These are the same options that are available on the **System setup** and **Paper setup** menus on the control-panel. For more information, see [Control panel menus](#).

Three options are available for handling print jobs when the product is out of media:

- Select **Wait For Paper To Be Loaded**.
- Select **Cancel** from the **Paper out action** drop-down list to cancel the print job.
- Select **Override** from the **Paper out time** drop-down list to send the print job to another paper tray.

The **Paper out time** field specifies how long the printer waits before acting on your selections. You can specify from 0 to 3600 seconds.



---

**NOTE** You must click **Apply** before your changes take effect.

---

## Printing

Use the HP ToolboxFX printing settings options to configure the settings for all print functions. These are the same options that are available on the **Print Settings** menu on the control panel. For more information, see [Control panel menus](#).



---

**NOTE** You must click **Apply** before your changes take effect.

---

## PCL5e

Use the PCL5e options to configure the settings when you are using the PCL5e print personality. These are the same options that are available on the **PCL5e** menu on the control panel.



---

**NOTE** You must click **Apply** before your changes take effect.

---

## PostScript

Use the PostScript option when you are using the PostScript print personality. When the **Print PostScript error** option is turned on, the PostScript error page automatically prints when PostScript errors occur.



---

**NOTE** You must click **Apply** before your changes take effect.

---

## Print quality

Use the HP ToolboxFX print-quality options to improve the appearance of your print jobs. These are the same options that are available on the **System setup** and **Print quality** menu on the control panel. For more information, see [Control panel menus](#).

The following options provided for controlling print quality are Color Calibration and Grayscale Printing.

- Color Calibration. The following options are available.
  - Power On Calibration
  - Calibration Timing
  - Calibrate Now
- Grayscale Printing. The following options are available.
  - **Resolution.** Select 600 resolution for average print jobs and Fast Res 1200 for higher-quality print jobs. Select ProRes 1200 for the highest-quality print job, but a longer printing time.
  - **REt.** You can turn on REt, which HP provides for improved print quality.
  - **Economode.** Turn Economode on when you are printing average print jobs. Economode reduces print quality, but increases the life of your print cartridge. To increase print quality, turn Economode off. HP does not recommend full-time use of Economode.



---

**NOTE** You must click **Apply** before your changes take effect.

---

## Print density

The print density settings allow you to make fine adjustments of the density (amount) of Cyan, Magenta, Yellow, and Black toner in your images, pages, and documents.

- **Contrasts.** Contrast is the density difference between light (highlight) and dark (shadow) colors. To increase the difference between light and dark colors (equivalent to a negative highlight adjustment and a positive shadow adjustment), use a positive contrast setting. To decrease the difference between light and dark colors (equivalent to a positive highlight adjustment and a negative shadow adjustment), use a negative contrast setting.
- **Highlights.** Highlight colors are colors near white. To make highlight colors darker, use a positive highlight setting, and to make highlight colors lighter use a negative highlight setting. This adjustment does not affect midtone or shadow colors.

- **Midtones.** Midtone colors are about halfway between white and solid density. To make midtone colors darker, use a positive midtone setting, and to make midtone colors lighter use a negative highlight setting. This adjustment does not affect highlight or shadow colors.
- **Shadows** Shadow colors are colors near solid density. To make shadow colors darker, use a positive shadow setting, and to make shadow colors lighter use a negative shadow setting. This adjustment does not affect highlight or midtone colors.

## Paper types

Use these HP ToolboxFX **Paper types** options to configure print modes that correspond to the various media types. When you select **Restore Modes**, all of the modes are reset to the factory settings.



---

**NOTE** You must click **Apply** before your changes take effect.

---

## Memory card (HP Color LaserJet 2605dtn)

Use the HP ToolboxFX memory card options to configure print settings when using memory cards.

Three options are available for configuring the printer when using memory cards.

- **Photo image size.** Select the size photos to print from the drop-down list.
- **Photo number of copies.** Type the number of copies from 0 to 99 to print for each image.
- **Photo output color.** Select either **Color** or **Monochrome** from the drop-down list.

Click the **Enable memory cards** checkbox to save the settings.

## System setup

Use the HP ToolboxFX system settings options to configure miscellaneous print settings. These settings are not available from the printer control panel.



---

**NOTE** You must click **Apply** before your changes take effect.

---

## Service

During the printing process, paper, toner, and dust particles can accumulate inside the printer. Over time, this buildup can cause print-quality problems such as toner specks or smearing. HP ToolboxFX provides an easy method for cleaning the paper path. For more information, see [To clean the paper path using HP ToolboxFX](#).

## Network settings

The network administrator can use the HP ToolboxFX **Network Settings** folder to control the network-related settings for the printer when it is connected to an IP-based network.

The following options are available:

- IP Configuration
- Advanced
- SNMP
- Network Configuration
- Password

## Using the embedded Web server

When the printer is directly connected to a computer, use the HP ToolboxFX to view Web pages for the printer status.

When the printer is connected to the network, the embedded Web server is automatically available. You may access the embedded Web server from any supported browser.

The embedded Web server allows you to view printer and network status and to manage printing functions from your computer instead of using the printer control panel. Below are examples of what you can do using the embedded Web server:

- View printer status information.
- Set the type of paper loaded in each tray.
- Determine the remaining life on all supplies and order new ones.
- View and change tray configurations.
- View and change the printer.
- View and print internal information pages.
- View and change network configuration.

The embedded Web server supports the following browsers:

- Microsoft Internet Explorer 6.0 and later
- Netscape 7.0 or later
- Opera 7.0 or later
- Firefox 1.0 or later
- Mozilla 1.6 or later
- Safari 1.2 or later

The embedded Web server works when the printer is connected to an IP-based network. The embedded Web server does not support IPX-based or AppleTalk printer connections. You do not need Internet access to open and use the embedded Web server.

### To access the embedded Web server using a network connection

In a supported Web browser on your computer, type the IP address for the printer in the address/URL field. (To find the IP address, print a configuration page. For more information about printing a configuration page, see [Configuration page](#).)



**NOTE** If you are unable to access the embedded Web server using the IP address, you can use the host name.

**NOTE** Once you open the URL, you can bookmark it so that you can return to it quickly in the future.

---

1. The embedded Web server has three tabs that contain settings and information about the printer: the **Information** tab, the **Settings** tab, and the **Networking** tab. Click the tab that you want to view.
2. See the following sections for more information about each tab.

## Information tab

The **Information** pages group consists of the following pages.

- **Device Status.** This page displays the printer status and shows the life remaining of HP supplies, with 0% indicating that a supply is empty. The page also shows the type and size of print media set for each tray.
- **Configuration.** This page displays the network and product information found on the printer Configuration page, such as page counts, print settings, and paper options.
- **Supplies Status.** This page displays the life remaining of HP supplies, with 0% indicating that a supply is empty. This page also provides supplies part numbers. To order new supplies, click **Order Supplies** in the **Other Links** area on the left side of the window. To visit any website, you must have Internet access.
- **Print Info Pages.** This page provides a remote way to print an internal page for a printer.

## Settings tab

This tab allows you to configure the printer from your computer. The **Settings** tab can be password protected. If this printer is networked, always consult with the printer administrator before changing settings on this tab.

The **Settings** tab contains the following pages.

- **Paper Handling.** Configure paper handling settings from this page.
- **Printing.** Configure the IO Timeout from this page.
- **Print Quality.** Use this page to configure color calibration and optimize settings.
- **Print Density.** Use this page to configure print density settings including contrast, highlights, midtones, and shadows.
- **Paper Type Settings.** Use this page to configure paper types
- **Print Modes.** Use this page to configure print mode settings.
- **System Setup.** Use this page to set up system settings, including jam recovery, auto continue, display contrast, and printer language.
- **Service.** Use this page to start the cleaning mode and restore factory settings.



## Networking tab

This tab allows the network administrator to control network-related settings for the printer when it is connected to an IP-based network.

- **IP Configuration.** Use this page to set the IP configuration.
- **Advanced.** Use this page to enable network features such as SLP Config, DHCP, BootP, and AutoIP.
- **mDNS.** Use this page to set the mDNS. Use these settings to turn on or off Rendezvous or Bonjour discovery.
- **SNMP.** Use this page to set SNMP protocols.
- **Password.** Use this page to set or change the Administrator Password.

## Other links found in HP ToolboxFX

This section contains links that connect you to the Internet. You must have Internet access in order to use any of these links. If you use a dial-up connection and did not connect when you first opened the embedded Web server, you must connect before you can visit these websites. Connecting might require that you close the embedded Web server and reopen it.

- **HP Instant Support™.** Connects you to the HP website to help you find solutions. This service analyzes your printer error log and configuration information to provide diagnostic and support information specific to your printer.
- **Product Registration.** Click this link to connect to the HP website to register the product.
- **Order Supplies.** Click this link to connect to the HP website and order genuine HP supplies, such as print cartridges and paper.
- **Product Support.** Connects to the support site for the HP Color LaserJet 2605 series printers where you can search for help regarding general topics.



# 11 Maintenance

This chapter contains information about these maintenance topics:

- [Managing supplies](#)
- [Cleaning the printer](#)
- [Cartridge out override](#)
- [Changing print cartridges](#)
- [Calibrating the printer](#)

# Managing supplies

For warranty information about these supplies, see [Print Cartridge Limited Warranty Statement](#).

## Supplies life

The life of a print cartridge depends on the amount of toner that print jobs require. When printing text at approximately 5% coverage, a cyan, magenta, or yellow print cartridge for the HP Color LaserJet 2605 series printers lasts an average of 2,000 pages, and a black print cartridge lasts an average of 2,500 pages. A typical business letter has 5% coverage.

## Checking and ordering supplies

You can check the supplies status by using the printer control panel, printing a Supplies Status page, or viewing the HP ToolboxFX. Hewlett-Packard recommends that you place an order for a replacement print cartridge when you first receive the Low message for a print cartridge. For typical use, the Order message indicates that approximately two weeks of life remains. When you use a new, authentic HP print cartridge, you can obtain the following types of supplies information:

- Amount of cartridge remaining
- Estimated number of pages remaining
- Number of pages printed
- Other supplies information



---

**NOTE** If the printer is connected to the network, you can set the HP ToolboxFX to notify you by e-mail when a print cartridge is low or is near the end of its useful life. If the printer is directly connected to a computer, you can set HP ToolboxFX to notify you when supplies are low.

---

## To check status and order using the control panel

Do one of the following:

- Check the supplies status gauges on the printer control panel. These gauges indicate when a print cartridge is low or empty. The lights also indicate when a non-HP print cartridge is first installed.
- To print the Supplies Status page from the printer, on the printer control panel, select **Reports Menu**, and then **Supplies Status**. See [Supplies Status page](#) for more information.

If the supplies levels are low, you can order supplies through your local HP dealer, by telephone, or online. See [Accessories and ordering information](#) for part numbers. See <http://www.hp.com/go/ljsupplies> to order online.

## To check and order supplies using HP ToolboxFX

You can configure HP ToolboxFX to notify you when the supplies are low. You can choose to receive alerts by e-mail or as a pop-up message or taskbar icon. To order supplies by using the HP ToolboxFX, in the **Other Links** area, click **Order supplies**. You must have Internet access to connect to the website.

For more information, see [HP ToolboxFX](#).

## To check and order using HP Web Jetadmin

In HP Web Jetadmin, select the printer. The device status page shows supplies information. To order, use the HP ToolboxFX. Or, see [Accessories and ordering information](#).

## Storing supplies

Follow these guidelines for storing print cartridges:

- Do not remove the print cartridge from its package until you are ready to use it.



---

**CAUTION** To prevent damage, do not expose the print cartridge to light for more than a few minutes.

---

- See [Table C-4 Environmental specifications](#) for operating and storage temperature ranges.
- Store the supply in a horizontal position.
- Store the supply in a dark, dry location away from heat and magnetic sources.

## Replacing and recycling supplies

To install a new HP print cartridge, follow the instructions that are included on the box that contains the new supply, or see the *Getting Started Guide*.

To recycle supplies, place the used supply in the box in which the new supply arrived. Use the enclosed return label to send the used supply to HP for recycling. For complete information, see the recycling guide that is included with each new HP supply item. See [HP LaserJet printing supplies](#) for more information about HP's recycling program.

## HP policy on non-HP supplies

Hewlett-Packard Company cannot recommend the use of non-HP supplies, either new or remanufactured. Because they are not HP products, HP cannot influence their design or control their quality. Service or repairs required as a result of using a non-HP supply will *not* be covered under the printer warranty.

When you insert a supply into the printer, the printer will inform you if the supply is not a genuine HP supply. If you insert a genuine HP supply that has reached the low state from another HP printer, the printer identifies the supply as non-HP. Simply return the supply to the original printer to reactivate HP features and functionality.

## Resetting the printer for non-HP supplies

When you install a non-HP print cartridge, the light next to the print cartridge you replaced blinks and the Attention light is on. In order to print with this supply, you must press  (Select) the first time you install this non-HP supply. The status gauges will not indicate when this type of supply is low or empty.



---

**CAUTION** The printer will not stop printing when this type of supply is empty. Printer damage could occur if the printer prints with an empty print cartridge. See [Hewlett-Packard limited warranty statement](#) and [Print Cartridge Limited Warranty Statement](#).

---

## HP anti-counterfeit website

Visit the HP anti-counterfeit website at <http://www.hp.com/go/anticounterfeit> if the supplies status gauges or HP ToolboxFX indicates that the print cartridge is not an HP print cartridge and you think that it is genuine.

## Cleaning the printer

During the printing process, paper, toner and dust particles can accumulate inside the printer. Over time, this buildup can cause print-quality problems such as toner specks or smearing. This printer has a cleaning mode that can correct and prevent these types of problems.

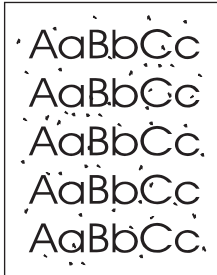

### To remove toner build-up

During the printing process, toner can accumulate inside the printer. Over time, this buildup can cause print-quality problems. Each time you replace the black print cartridge, remove toner build-up.

1. Open the front door.

2. Locate the blue cleaning tool that is situated to the left above the black print cartridge.

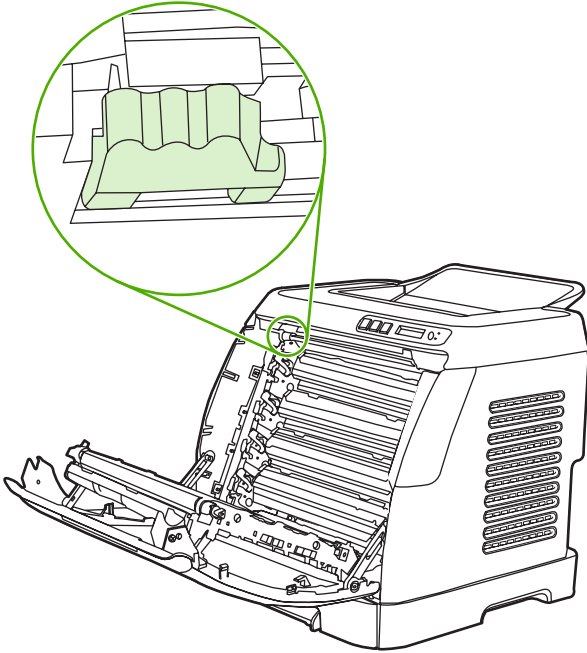

3. Move the cleaning tool back and forth across the cartridge five times.

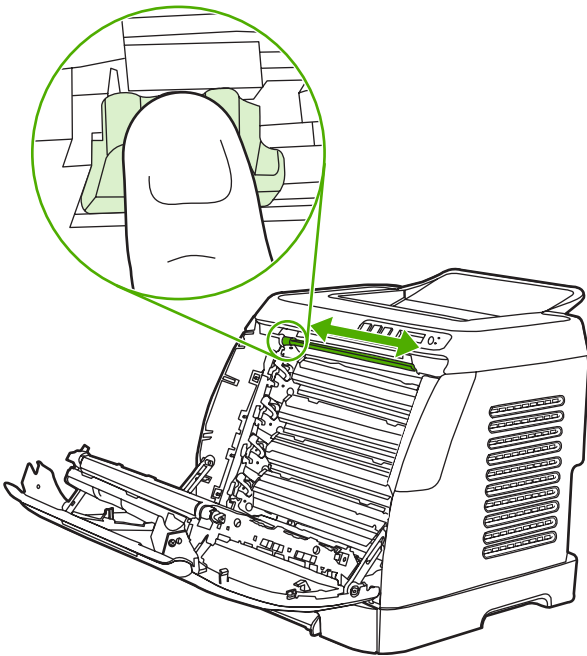

4. Ensure that the cleaning tool is returned to the left when the cleaning is finished.
5. Close the front door.
6. Run a cleaning page.



**NOTE** You will get toner on your hands when you perform this cleaning. To remove toner, wash your hands with cool water.



## To clean the paper path using HP ToolboxFX



**NOTE** Use the following procedure to clean the paper path using the HP ToolboxFX. To clean the engine when the computer is running an operating system that does not support HP ToolboxFX, see the late-breaking Readme on the root of the CD-ROM, or visit <http://www.hp.com/support/clj2605>.

1. Make sure that the printer is turned on and in the Ready state.
2. Open the HP ToolboxFX.
3. On the **Troubleshooting** tab, click **Maintenance**, click **Cleaning Page** and then click **Print**. A page with a pattern prints from the printer.
4. At the printer, remove any print media in Tray 2 or optional Tray 3.
5. Remove the page that printed and load it face-down into Tray 2 or optional Tray 3.

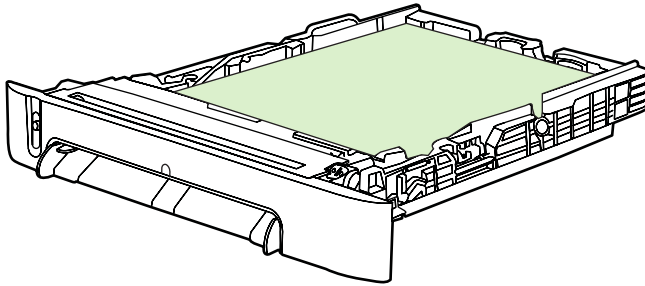

6. At the computer, press **Clean**.

# Cartridge out override

## What is it?

The HP Color LaserJet 2605 series printers display an **Order supplies** message when a cartridge is running low and a **Replace Supplies** message when a cartridge has been depleted. **To ensure optimal print quality, HP recommends replacing a cartridge when the Replace Supplies message is displayed.** Replacing the cartridge at this point can help prevent waste of media or other cartridges when one cartridge produces poor print quality.

The Cartridge Out Override feature allows the printer to continue using a cartridge that has reached the recommended replacement point.



---









**WARNING!** Using Override may result in unsatisfactory print quality and unavailability of certain features (such as toner remaining information).

**WARNING!** All print defects or supply failures incurred when an HP supply is used in Override will not be considered defects in materials or workmanship in the supply under HP's Print Cartridge Limited Warranty Statement. For Warranty information, see [Print Cartridge Limited Warranty Statement](#).

---

## Configuration

Cartridge Out Override can only be enabled from the printer's control panel menu.

1. From the main menu, press  (Right arrow) to **System setup** and press  (Select).
2. Press  (Right arrow) to **Print quality** and press  (Select).
3. Press  (Right arrow) to **Replace Supplies** and press  (Select).
4. Press  (Right arrow) to **Override out** and press  (Select).
5. Press  (Select).

If **Stop at out** is selected, the printer will stop printing when a cartridge reaches the recommended replacement point. If **Override out** is selected, the printer will continue printing when a cartridge reaches the recommended replacement point. The factory default setting is **Stop at out**.

## On-going operation

Override can be enabled or disabled at any time, and does not have to be re-enabled for each cartridge. The printer will automatically continue printing when a cartridge reaches recommended replacement. The printer will display a message **Replace supply Override in use** while a cartridge is used in Override mode. When the cartridge is replaced with a new supply, Override will de-activate until another cartridge reaches recommended replacement.

# Changing print cartridges

When a print cartridge approaches the end of useful life, the control panel displays a message recommending that you order a replacement. The printer can continue to print using the current print cartridge until the control panel displays a message instructing you to replace the cartridge.

The printer uses four colors and has a different print cartridge for each color: black (K), cyan (C), magenta (M), and yellow (Y).

Replace a print cartridge when the printer control panel displays one of the following messages: **Replace yellow cartridge**, **Replace magenta cartridge**, **Replace cyan cartridge**, **Replace black cartridge**. The control panel display also indicates the color that should be replaced (unless a genuine HP cartridge is not currently installed).

## To change the print cartridge

1. Open the front door.

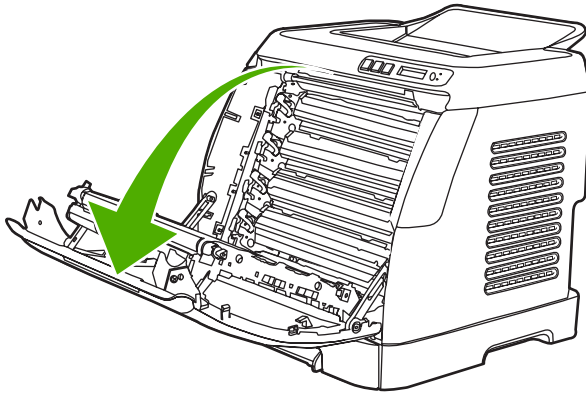

**CAUTION** Do not place anything on the transfer belt (ETB), which is located on the inside of the front door.

2. Remove the used print cartridge from the printer.

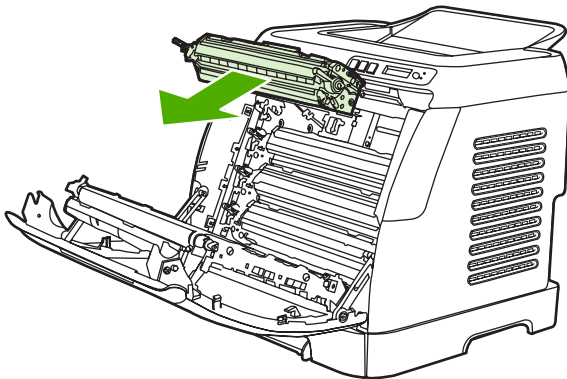

3. Remove the new print cartridge from the bag. Place the used print cartridge in the bag for recycling.

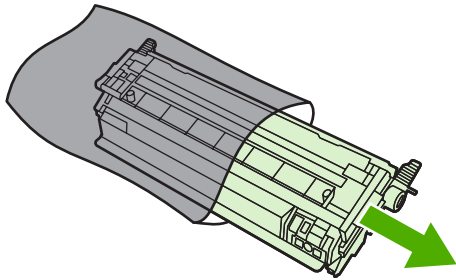

4. Grasp both sides of the print cartridge by the blue handles and distribute the toner by gently rocking the print cartridge from side to side.



**CAUTION** Do not touch the shutter or the surface of the roller.

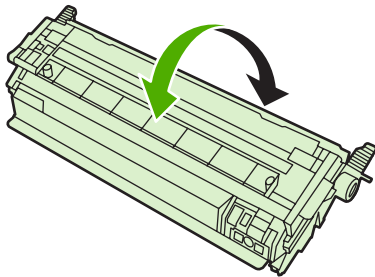

5. Remove the shipping locks and the shipping tape from the new print cartridge. Discard the shipping tape and shipping locks according to local regulations.

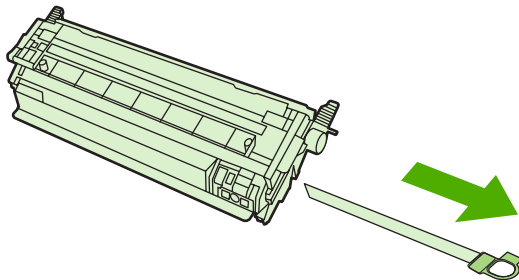

6. Align the print cartridge with the tracks inside the printer, and using the handles, insert the print cartridge until it is firmly seated.

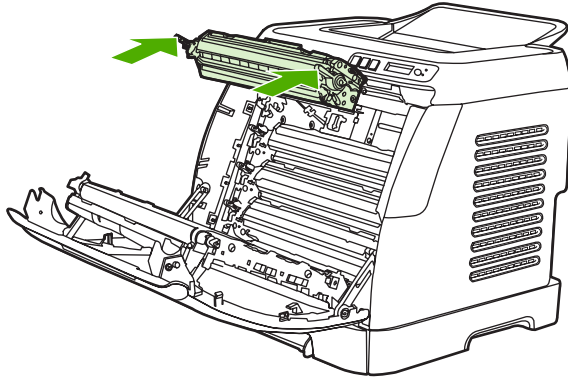

7. Firmly close the front door.

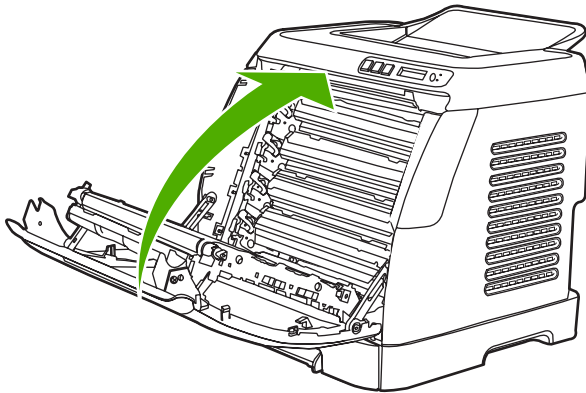

After a short time, the control panel should display **Ready**.



---

**NOTE** If a cartridge is in the wrong slot or is the wrong type for the printer, the control panel will display one of the following messages: **Incorrect yellow**, **Incorrect magenta**, **Incorrect cyan**, **Incorrect black**, or **Incorrect supplies**.

---

8. Installation is complete. Place the used print cartridge in the box in which the new cartridge arrived. See the enclosed recycling guide for recycling instructions.
9. If you are using a non-HP print cartridge, check the printer control panel for further instructions.

For additional help, go to <http://www.hp.com/support/clj2605>.



---

**NOTE** When replacing or changing a black print cartridge, a cleaning page will automatically be printed. This helps prevent speckles on the front or back of printed documents. For a more thorough cleaning, see [To clean the paper path using HP ToolboxFX](#).

---













# Calibrating the printer

The printer automatically calibrates at various times. You can adjust the calibration settings by using the HP ToolboxFX.

Environmental differences or aging print cartridges might cause fluctuations in image density. The printer accounts for this with image stabilization control. The printer automatically calibrates at various times to maintain the highest level of print quality. You can also request a calibration by using the HP ToolboxFX.

The printer does not interrupt a print job to calibrate. It waits until the job is complete before calibrating or cleaning. While the printer is calibrating, it pauses printing for the time that is required to complete the calibration.

## To calibrate the printer at the printer

1. To calibrate from the printer, press  (Left arrow) or  (Right arrow) until the display reads **System setup**.
2. Press  (Select).
3. Press  (Left arrow) or  (Right arrow) until the display reads **Print quality**.
4. Press  (Select).
5. Press  (Left arrow) or  (Right arrow) until the display reads **Calibrate color**.
6. Press  (Select).
7. Press  (Left arrow) or  (Right arrow) until the display reads **Calibrate now**.
8. Press  (Select).
9. Press  (Select) to confirm **Calibrate now**.

## To calibrate the printer from the HP ToolboxFX

1. Open the HP ToolboxFX in one of these ways:
  - On the desktop, double-click the **HP ToolboxFX** icon.
  - On the **Start** menu, point to **Programs**, point to **HP**, point to **HP Color LaserJet 2605 series**, and click **HP ToolboxFX**.
2. Click the **Troubleshooting** tab and then click **Troubleshooting Tools** (on the left side of the screen).
3. In the Calibration section, click **Calibrate now**.

# 12 Problem solving

This troubleshooting information is organized to help you resolve printing problems. Choose the general topic or type of problem from the following list.

- [Troubleshooting process](#)
- [Control panel messages](#)
- [Clearing jams](#)
- [Print problems](#)
- [Troubleshooting tools](#)

# Troubleshooting process

Use the troubleshooting checklist to solve issues with the printer.

## Troubleshooting checklist

Follow the steps below when trying to solve a problem with the printer.

Step number	Verification step	Possible problems	Solutions
1	<p><b>Is the power on?</b></p> <p>When the printer is connected to a grounded power source, the control panel shows <b>Hewlett-Packard</b> with both the Ready and Attention lights blinking. The control panel will then display <b>Initializing</b> and then <b>Ready</b>, at which time only the green light will be on.</p>	No power due to failed power source, cable, switch, or fuse.	<ol style="list-style-type: none"> <li>1. Verify that the printer is plugged in.</li> <li>2. Verify that the power cable is functional and that the power switch is on.</li> <li>3. Check the power source by plugging the printer directly into the wall or into a different outlet.</li> <li>4. Test the outlet or connect another device to the outlet to verify that the outlet is functioning.</li> </ol>
2	<p><b>Does Ready appear in the printer control panel?</b></p> <p>The control panel should function without error messages.</p>	Control panel shows an error.	<p>See <a href="#">Control panel messages</a> for a list of common messages that will help you correct the error.</p> <p>If the error persists, contact HP Customer Care. See <a href="#">HP Customer Care</a> or the support flyer that came in the printer box.</p>
3	<p><b>Do information pages print?</b></p> <p>Print a Configuration page.</p>	<p>Control panel displays an error message.</p> <hr/> <p>Media does not move smoothly through the printer paper path.</p> <hr/> <p>Poor print quality.</p>	<p>See <a href="#">Control panel messages</a> for a list of common messages that will help you correct the error.</p> <hr/> <p>Clean the paper path.</p> <hr/> <p>See <a href="#">Print quality problems</a>.</p> <p>If the error persists, contact HP Customer Care. See <a href="#">HP Customer Care</a> or the support flyer that came in the printer box.</p>
4	<p><b>Does the printer print from the computer?</b></p> <p>Connect the network cable or USB cable to the printer and the computer. Use a word-processing application to send a print job to the printer.</p>	<p>Software is not installed correctly or an error occurred during software installation.</p> <hr/> <p>The cable is not connected correctly.</p> <hr/> <p>An incorrect driver is selected.</p> <hr/> <p>Other devices are connected to the USB port.</p> <hr/> <p>There is a port driver problem in Microsoft Windows.</p>	<p>Uninstall and then reinstall the printer software. Verify that you are using the correct installation procedure and the correct port setting.</p> <hr/> <p>Reconnect the cable.</p> <hr/> <p>Select the proper driver.</p> <hr/> <p>Disconnect the other devices and try again to print.</p> <hr/> <p>Uninstall and then reinstall the printer software. Verify that you are using the</p>





Step number	Verification step	Possible problems	Solutions
			correct installation procedure and the correct port setting.
		If the error persists, contact HP Customer Care. See <a href="#">HP Customer Care</a> or the support flyer that came in the printer box.	
5	Does the printer recognize and print from a memory card?  Insert a memory card and print an index page.	The printer does not recognize the card.	Remove the card and reinsert it into the memory card slot. Verify that the card is fully inserted into the slot.  Verify that the memory card type is a supported type.  Verify that only one card is inserted in the memory-card slots.
		The printer does not print certain images.	Verify that the files on the memory card are in the correct format. The printer recognizes only SRGB format .JPEG files.









# Control panel messages

The majority of the control-panel messages are intended to guide the user through typical operation. The control-panel messages indicate the status of the current operation, and include a page count on the second line of the display, if appropriate. When the device is print data, control-panel messages indicate this status. In addition, alert messages, warning messages, and critical error messages indicate situations that might require some action.





## Alert and warning messages

Alert and warning messages appear temporarily and might require the user to acknowledge the message by pressing  (**Select**) to resume or by pressing  (**Cancel Job**) to cancel the job. With certain warnings, the job might not complete or the print quality might be affected. If the alert or warning message is related to printing and the auto-continue feature is on, the printer will attempt to resume the printing job after the warning has appeared for 10 seconds without acknowledgement.





**Table 12-1** Alert and warning messages

Control panel message	Description	Recommended action
<b>10.000x Supply error</b>	E-label cannot be read or print cartridge is not properly installed.	<ol style="list-style-type: none"> <li>1. Reinstall print cartridge.</li> <li>2. Power cycle printer.</li> <li>3. If the problem is not solved, replace the cartridge.</li> </ol>
<b>Device error</b> <b>Press </b>	An internal error occurred in the printer.	Press  ( <b>Select</b> ) to resume the job.
<b>Door open</b>	The printer door is open.	The door must be closed before printing can continue.
<b>Engine comm. error</b>	The printer experienced an internal communication error.	This is a warning message only. Job output might be affected.
<b>Engine error</b> <b>Press </b>	An internal error occurred in the printer.	<b>Press </b> to resume the job.
<b>Insert memory card</b>	Card is not in memory slot or is not inserted completely.	Insert card or verify that card is inserted completely.
<b>Invalid driver</b> <b>Press </b>	You are using the incorrect printer driver.	Reselect the printer driver appropriate for your printer.
<b>Jam in cartridge area</b> alternates with <b>Clear jam and then press </b>	A paper jam has occurred in the cartridge area.	Open the door and clear the jam Then press the  ( <b>Select</b> ) button on the control panel.
<b>Jam in</b>	A paper jam has occurred in the output bin.	Open the door and clear the jam Then press the  ( <b>Select</b> ) button on the control panel.

**Table 12-1** Alert and warning messages (continued)

Control panel message	Description	Recommended action
<p>ouput bin</p> <p>alternates with</p> <p><b>Clear jam and then press ✓</b></p>		
<p><b>Jam in print paper path</b></p> <p>alternates with</p> <p><b>Clear jam and then press ✓</b></p>	<p>A paper jam has occurred in the print paper path.</p>	<p>Open the door and clear the jam Then press the  (<b>Select</b>) button on the control panel.</p>
<p><b>Jam in tray 1</b></p> <p>alternates with</p> <p><b>Clear jam and then press ✓</b></p>	<p>A paper jam has occurred in Tray 1.</p>	<p>Clear the jam, and then press the  (<b>Select</b>) button on the control panel.</p>
<p><b>Jam in tray 2</b></p> <p>alternates with</p> <p><b>Clear jam and then press ✓</b></p>	<p>A paper jam has occurred in Tray 2.</p>	<p>Clear the jam, and then press the  (<b>Select</b>) button on the control panel.</p>
<p><b>Jam in tray 3</b></p> <p>alternates with</p> <p><b>Clear jam and then press ✓</b></p>	<p>A paper jam has occurred in Tray 3.</p>	<p>Clear the jam, and then press the  (<b>Select</b>) button on the control panel.</p>
<p><b>Load paper</b></p>	<p>The printer is out of paper.</p>	<p>Load paper.</p>
<p><b>Load Tray X [TYPE] [SIZE]</b></p>	<p>The printer is processing job, but the tray indicated is empty or does not contain the media needed.</p>	<p>Load specified paper type and size into the tray as indicated on the control panel.</p>
<p><b>Load Tray X Press ✓</b></p>	<p>The printer has processed the first page of a 2-sided print job and is prompting the user to load paper for the second page.</p>	<p>Load the printed page from the output bin into the tray prompted on the control panel.</p>
<p><b>Manual feed Press ✓</b></p> <p>alternates with</p>	<p>The printer is waiting for paper in the tray indicated.</p>	<p>Load the paper as indicated.</p>

**Table 12-1** Alert and warning messages (continued)

Control panel message	Description	Recommended action
<b>Load tray 1</b> [TYPE] [SIZE]		
<b>Memory card is in backwards</b>	The memory card was inserted backwards into the card slot.	Remove, turn, and reinsert the card.
<b>Memory is low</b> Press ✓	The printer memory has been almost completely filled.	Allow the printer to finish the job, or press the  (Select) button to cancel the job.  Break the job into smaller jobs that contain fewer pages.
<b>Misprint</b> Press ✓	The printed pages have been incorrectly placed on the paper.	To continue, press the  (Select) button on the control panel.
<b>No paper pickup</b> Press ✓	The print engine has failed to pick up a piece of media.	In Tray 1, verify that the media was inserted far enough into the tray. In Tray 2 or optional Tray 3, verify that the paper-length guide is in the correct position for the media size that you are using.  Reload the media in the input tray and press  (Select) to continue the job.  If the error persists, contact HP Customer Care. See <a href="#">HP Customer Care</a> or the support flyer that came in the printer box.
<b>Only 1 memory card at a time</b>	More than one memory card has been inserted.	Remove all but one memory card.
<b>Page too complex</b> Press ✓	The page is too complex for the printer to process.	Press the  (Select) button and try to reprint the page.  For multiple page jobs, print pages separately.
<b>Photo job pending</b>	Second photo job was started prior to completion of the first job.	No action required. Message will cease when first job completes.
<b>Photos not found</b>	An image has been selected that has been deleted.  The image checked on the bubble sheet has been deleted.  Memory card has been removed from the memory slot.	Reinsert the card and reselect the image.
<b>Replace supplies</b> Override in use	A supply is low and using Override may result in unsatisfactory print quality.	Replace the supply that is low.
<b>Unauthorized yellow</b> <b>Unauthorized magenta</b>	A new supply has been installed that is not made by HP. One of these four messages is displayed until an HP supply is installed or  (Select) is pressed.	If you believe you purchased an HP supply, please call the HP fraud hotline at 1-877-219-3183. Service or repairs

**Table 12-1** Alert and warning messages (continued)

Control panel message	Description	Recommended action
<b>Unauthorized cyan</b> <b>Unauthorized black</b>		required as a result of using non-HP supplies is not covered under HP warranty.  To continue printing, press  (Select).
<b>Unexpected size in tray 1</b>  alternates with <b>Load [SIZE]</b> <b>Press ✓</b>	The paper that the job printed on does not match the size expected.	Load specified paper type and size into the tray indicated.
<b>Unexpected size in tray 2</b>  alternates with <b>Load [SIZE]</b> <b>Press ✓</b>	The paper that the job printed on does not match the size expected.	Load specified paper type and size into the tray indicated.
<b>Unexpected size in tray 3</b>  alternates with <b>Load [SIZE]</b> <b>Press ✓</b>	The paper that the job printed on does not match the size expected.	Load specified paper type and size into the tray indicated.
<b>Unknown Memory Card Error</b>	There is an issue with either the memory card or the printer memory-card reader.	Reinsert the card. If the error persists, insert a different card.  If the error persists, contact HP Customer Care. See <a href="#">HP Customer Care</a> or the support flyer that came in the printer box.
<b>Unsupported memory card</b>	The memory card that you have inserted is not a type that is supported.	Insert a card that is supported.

## Critical error messages

Critical error messages can indicate some kind of failure. Cycling the power might fix the problem. If a critical error persists, the printer might require service.

**Table 12-2** Critical error messages

Control panel message	Description	Recommended action
<b>49 Error</b> <b>Turn off then on</b>	The printer has experienced an internal firmware error.	Turn off the power by using the power switch, wait at least 30 seconds, and then turn on the power and wait for the printer to initialize.

**Table 12-2** Critical error messages (continued)

Control panel message	Description	Recommended action
		<p>If you have recently installed a memory DIMM in the printer, turn off the printer, remove the memory DIMM, reinstall the DIMM to verify that it is seated properly, and then turn on the printer.</p> <p>If a surge protector is being used, remove it. Plug the printer directly into the wall socket. Use the power switch to turn the printer on.</p> <p>If the error persists, contact HP Customer Care. See <a href="#">HP Customer Care</a> or the support flyer that came in the printer box.</p>
<p><b>50 Fuser Error</b></p> <p>Turn off then on</p>	<p>The printer has experienced an internal hardware error.</p> <p><b>50.1 Fuser Error</b> - Low fuser error</p> <p><b>50.2 Fuser Error</b> - Slow fuser error</p> <p><b>50.3 Fuser Error</b> - High fuser error</p> <p><b>50.7 Fuser Error</b> - Fuser open error</p> <p><b>50.8 Fuser Error</b> - Low subthermistor fuser error</p> <p><b>50.9 Fuser Error</b> - High subthermistor fuser error</p>	<p>Turn off the printer, wait at least 25 minutes, and then turn on the printer.</p> <p>If a surge protector is being used, remove it. Plug the printer directly into the wall socket. Use the power switch to turn on the printer.</p> <p>If the error persists, contact HP Customer Care. See <a href="#">HP Customer Care</a> or the support flyer that came in the printer box.</p>
<p><b>51 Laser Error</b></p> <p>Turn off then on</p>	<p>The printer has experienced an internal hardware error.</p> <p><b>51.20 Error</b> - Black laser scanner error</p> <p><b>51.21 Error</b> - Cyan laser scanner error</p> <p><b>51.22 Error</b> - Magenta laser scanner error</p> <p><b>51.23 Error</b> - Yellow laser scanner error</p>	<p>Turn off the power by using the power switch, wait at least 30 seconds, and then turn on the power and wait for the printer to initialize.</p> <p>If a surge protector is being used, remove it. Plug the printer directly into the wall socket. Use the power switch to turn the printer on.</p> <p>If the error persists, contact HP Customer Care. See <a href="#">HP Customer Care</a> or the support flyer that came in the printer box.</p>
<p><b>54 Error</b></p> <p>Turn off then on</p>	<p>The printer has experienced a toner level sensor error.</p> <p><b>54.15 Error</b> - Yellow</p> <p><b>54.16 Error</b> - Magenta</p> <p><b>54.17 Error</b> - Cyan</p> <p><b>54.18 Error</b> - Black</p> <p><b>54.1C Error</b> - Density sensory contamination warning</p>	<p>Turn off the power by using the power switch, wait at least 30 seconds, and then turn on the power and wait for the printer to initialize.</p> <p>If a surge protector is being used, remove it. Plug the printer directly into the wall socket. Use the power switch to turn the printer on.</p> <p>If the error persists, contact HP Customer Care. See <a href="#">HP Customer Care</a> or the support flyer that came in the printer box.</p>
<p><b>55.0601 Error</b></p> <p><b>55.0602 Error</b></p>	<p>The printer has experienced an internal hardware error.</p>	<p>Turn off the power by using the power switch, wait at least 30 seconds, and then</p>

**Table 12-2** Critical error messages (continued)

Control panel message	Description	Recommended action
<b>55.1 Error</b> <b>59.A0 Error</b> <b>59.9 Error</b> <b>54.1C Error</b>		turn on the power and wait for the printer to initialize.  If a surge protector is being used, remove it. Plug the printer directly into the wall socket. Use the power switch to turn the printer on.  If the error persists, contact HP Customer Care. See <a href="#">HP Customer Care</a> or the support flyer that came in the printer box.
<b>57 Fan Error</b> <b>Turn off then on</b>	The printer has experienced a problem with its internal fan.	Turn off the power by using the power switch, wait at least 30 seconds, and then turn on the power and wait for the printer to initialize.  If the error persists, contact HP Customer Care. See <a href="#">HP Customer Care</a> or the support flyer that came in the printer box.
<b>79 Error</b> <b>Turn off then on</b>	The printer has experienced an internal firmware error.	Turn off the power by using the power switch, wait at least 30 seconds, and then turn on the power and wait for the printer to initialize.  If you have recently installed a memory DIMM in the printer, turn off the printer, remove the memory DIMM, reinstall the DIMM to verify that it is seated properly, and then turn on the printer.  If a surge protector is being used, remove it. Plug the printer directly into the wall socket. Use the power switch to turn the printer on.  If the error persists, contact HP Customer Care. See <a href="#">HP Customer Care</a> or the support flyer that came in the printer box.
<b>Duplexer Error</b> <b>Turn off then on</b>	The duplexer is not connected or installed correctly.	Turn off the power by using the power switch, wait at least 30 seconds, and then turn on the power and wait for the printer to initialize.  If a surge protector is being used, remove it. Plug the printer directly into the wall socket. Use the power switch to turn the printer on.  If the error persists, contact HP Customer Care. See <a href="#">HP Customer Care</a> or the support flyer that came in the printer box.
<b>Sensor error</b> <b>Turn off then on</b>	A sensor error has occurred.	Turn off the power by using the power switch, wait at least 30 seconds, and then turn on the power and wait for the printer to initialize.  If the error persists, contact HP Customer Care. See <a href="#">HP Customer Care</a> or the support flyer that came in the printer box.

## Clearing jams

Occasionally, paper or other print media can become jammed during a print job. Some causes include the following events:

- The input trays are loaded improperly or overfilled.
- Tray 2 or optional Tray 3 is opened during a print job.
- Too many sheets accumulated in the output area or sheets blocked the output area.
- The print media that is being used does not meet HP specifications. See [Print-media specifications](#).
- The environment in which the print media was stored is too humid or too dry. See [Print-media specifications](#).

### Where to look for jams

Jams can occur in these locations:

- Inside the printer. See [To clear jams from inside the printer](#).
- In input areas. See [To clear jams from Tray 2 or optional Tray 3](#).
- In the output area. See [To clear jams from the top bin \(HP Color LaserJet 2605\)](#).

Find and remove the jam by using the instructions on the following pages. If the location of the jam is not obvious, first look inside the printer.

Loose toner might remain in the printer after a jam. This problem should resolve itself after a few sheets have been printed.

Each section below corresponds to an area where a paper jam could occur. Use the following procedures to clear the jam. In all cases, grasp the jammed paper by both corners and pull slowly to remove the paper.



## To clear jams from inside the printer

**CAUTION** Jams in this area might result in loose toner on the page. If you get toner on your clothes or hands, wash them in cold water. (Hot water will set the toner into the fabric.)

1. Open the front door.

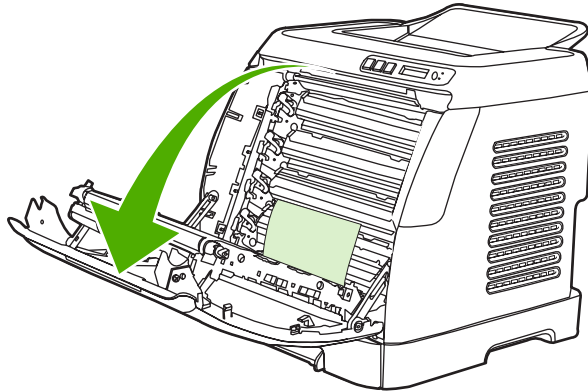

**CAUTION** Do not place anything on the transfer belt, which is located on the inside of the front door. Otherwise, the printer may be damaged, adversely affecting print quality.

2. Carefully grasp the jammed paper by both corners and pull slowly to remove the paper.

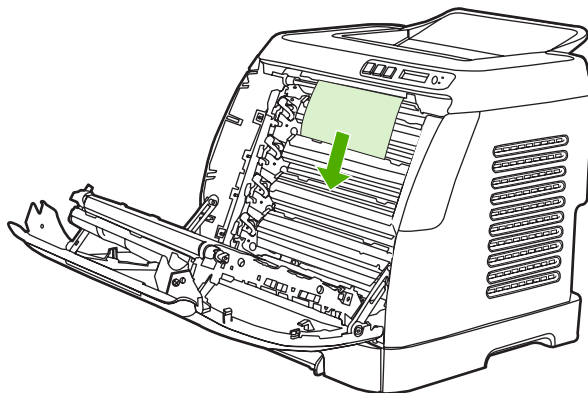
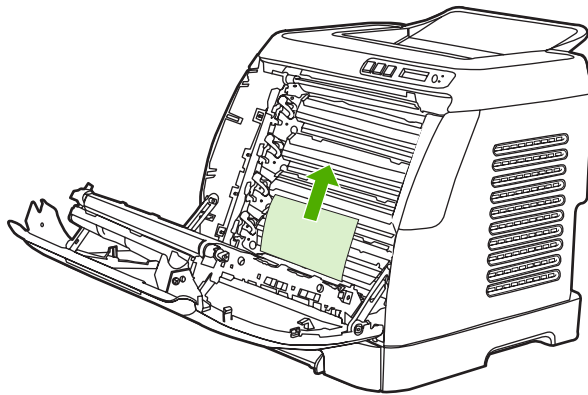

3. Close the front door.

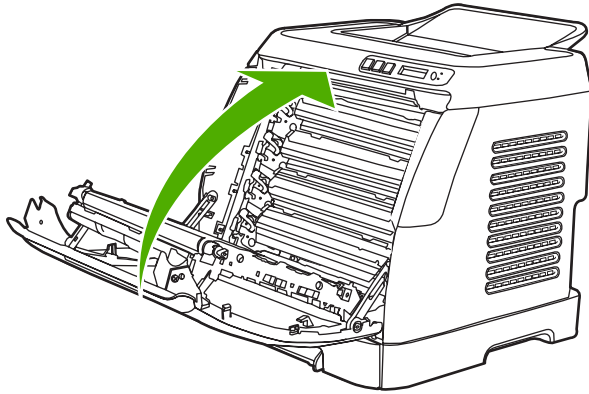

### To clear jams from the duplex area (HP Color LaserJet 2605dn and 2605dtn models only)

1. Open the front door completely.

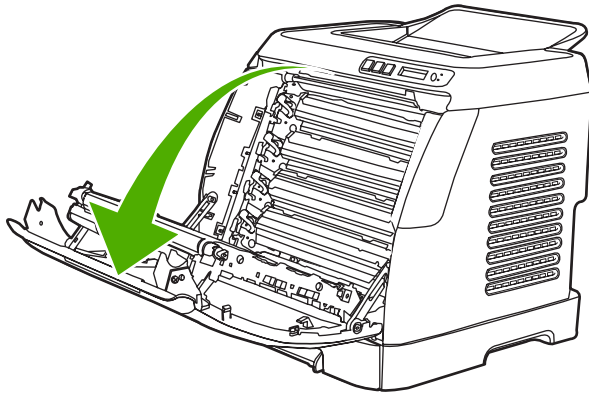

**CAUTION** Do not place anything on the transfer belt, which is located on the inside of the front door. Otherwise, the printer may be damaged, adversely affecting print quality.

2. Lift the ETB

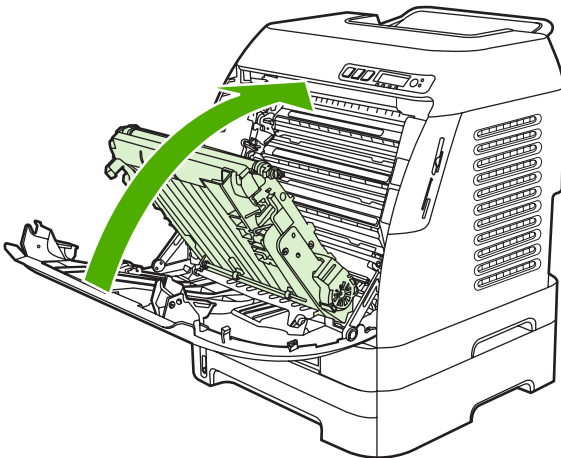

3. Remove any jammed paper.

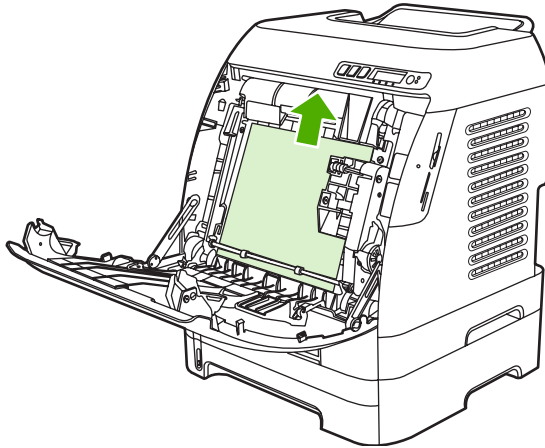

4. Close the ETB.

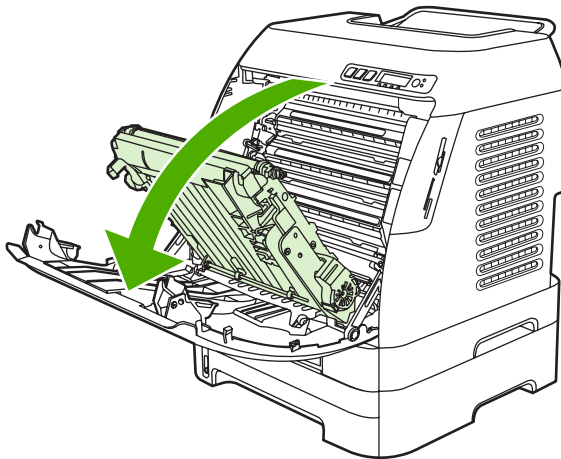

5. Close the front door.

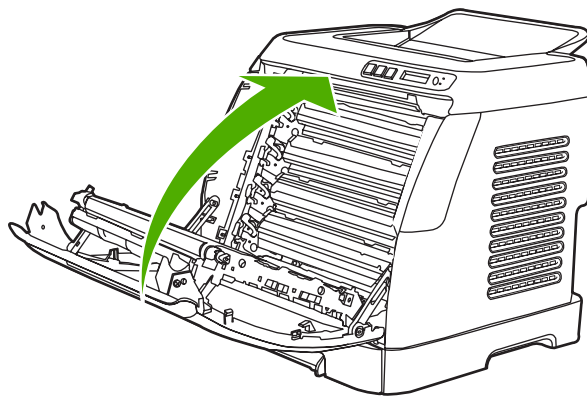

## To clear jams from the top bin (HP Color LaserJet 2605)

 **CAUTION** Jams in these areas might result in loose toner on the page. If you get toner on your clothes or hands, wash them in cold water. (Hot water will set the toner into the fabric.)

1. Carefully grasp the jammed paper by both corners and pull slowly to remove the paper from the top bin.



2. Open and close the front door.

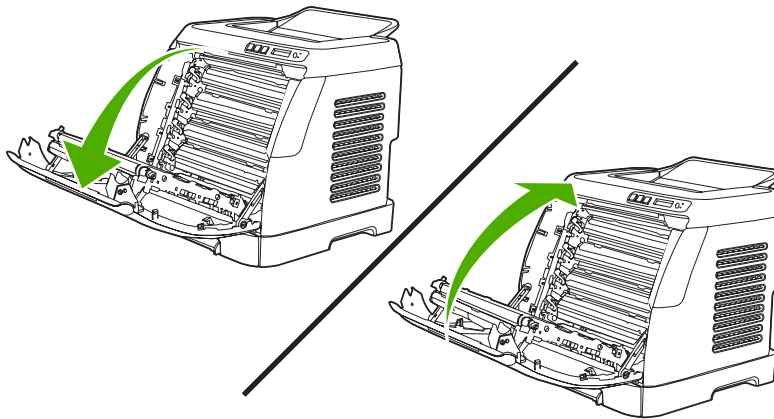

## To clear jams from the top output area (HP Color LaserJet 2605dn and 2605dtn models only)

1. Grip the top cover.

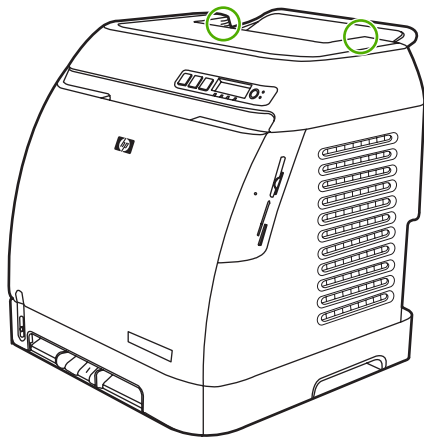

2. Open the top cover.

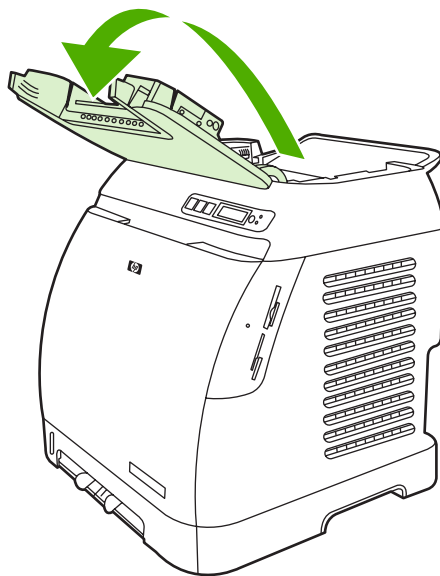

3. Remove any jammed paper.

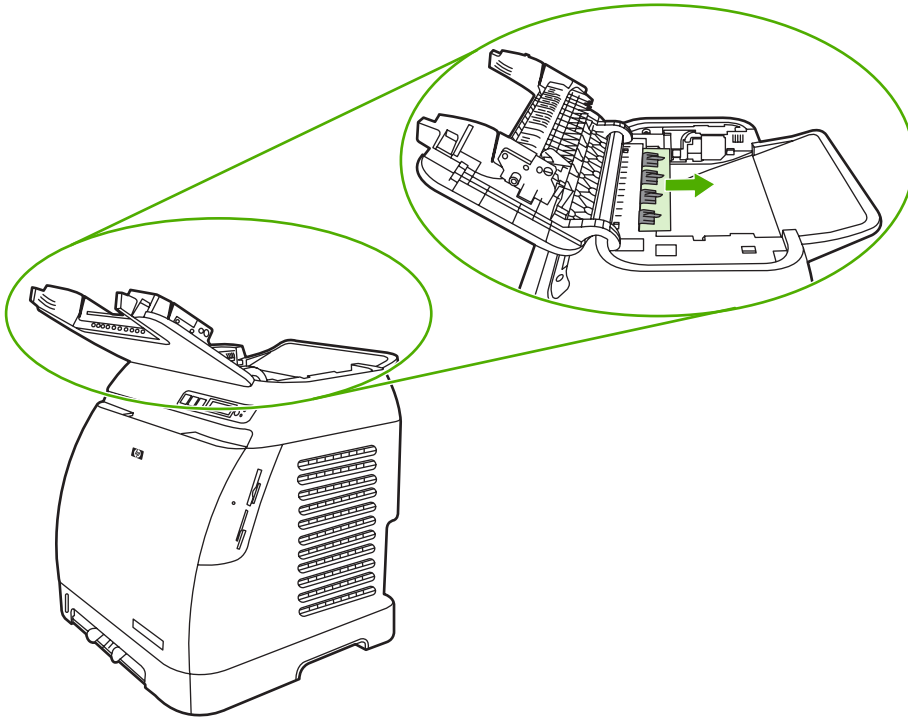

4. Close the top cover.

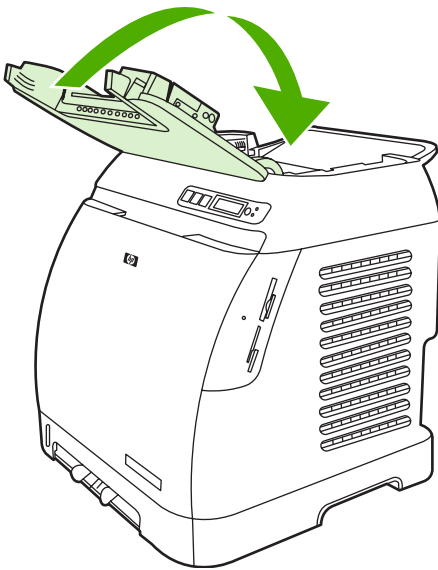

## To clear jams from Tray 2 or optional Tray 3



**NOTE** Before attempting to clear jams from Tray 2 or optional Tray 3, remove any jams inside the printer.

1. Pull Tray 2 or optional Tray 3 out of the printer.

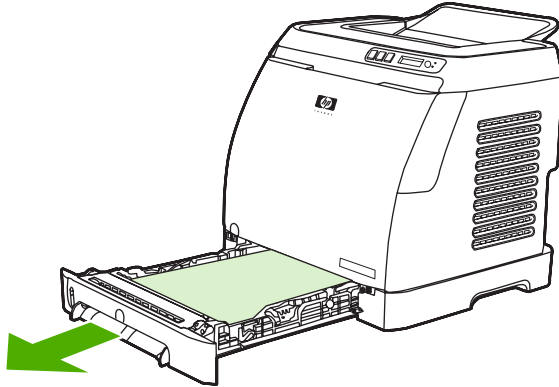

2. Carefully grasp the jammed paper by both corners and pull slowly to remove the paper.
3. Slide the tray into the printer.

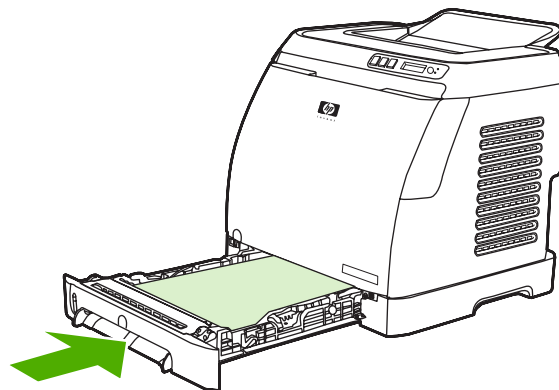

4. Open and close the front door.

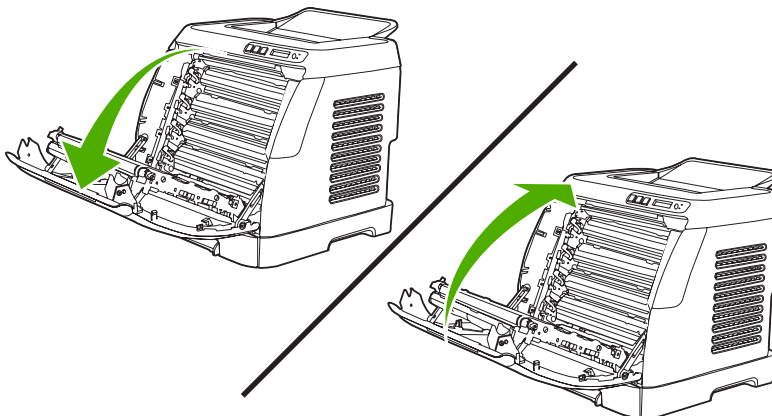

# Print problems

## Print quality problems

Occasionally, you might encounter problems with print quality. The information in the following sections helps you identify and resolve these issues.

### Identifying and correcting print defects

Use the checklist and print-quality issues charts in this section to solve print-quality problems.

#### Print-quality checklist

General print-quality problems can be solved by using the following checklist:

1. Make sure that the paper or print media that you are using meets specifications. Generally, smoother paper provides better results.
2. If you are using a special print media such as labels, transparencies, glossy, or letterhead, ensure that you have printed by type.
3. Remove any toner build-up and run a cleaning page. See [To remove toner build-up](#).
4. Print a Configuration page and Supplies Status page at the printer. See [Device pages and reports](#).
  - Check the Supplies Status page to see if any supplies are low or empty. No information is provided for non-HP print cartridges.
  - If the pages do not print correctly, the problem is with the hardware. Contact HP Customer Care. See [HP Customer Care](#) or the flyer that came in the printer box.
5. Print a Demo page from the HP ToolboxFX. If the page prints, the problem is with the printer driver. Try printing from the other printer driver. For example, if you are using the PCL 6 printer driver, print from the PS printer driver.



Use the Add Printer Wizard in the **Printers** (or **Printers and Faxes** in Windows XP) dialog box to install the PS driver.



6. Try printing from a different program. If the page prints correctly, the problem is with the program from which you were printing.
7. Restart the computer and the printer and try printing again. If the problem is not resolved, choose one of these options:
  - If the problem is affecting all printed pages, see [General print quality issues](#).
  - If the problem is affecting only pages printed in color, see [Solving issues with color documents](#).

#### General print quality issues

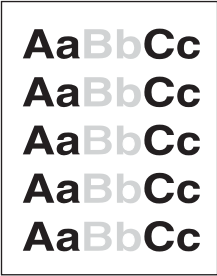
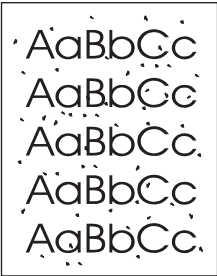

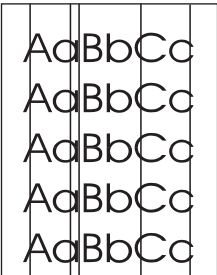
The following examples depict letter-size paper that has passed through the printer short edge first. These examples illustrate problems that would affect all of the pages that you print, whether you print in color or in black only. The topics that follow list the typical cause and solution for each of these examples.

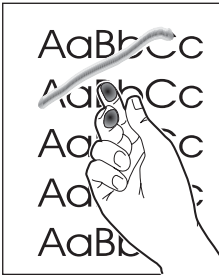
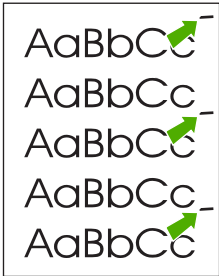

Problem	Cause	Solution
<p>Print is light or faded.</p> 	<p>The media might not meet HP specifications.</p> <hr/> <p>One or more print cartridges might be low. If you are using non-HP print cartridges, no messages appear on the printer control panel or in the HP ToolboxFX.</p>	<p>Use media that meets HP specifications.</p> <hr/> <p>Replace any low print cartridges. See <a href="#">Changing print cartridges</a>.</p> <p>If none of the print cartridges is low or empty, remove the print cartridges one at a time and inspect the toner roller in each to see if the roller is damaged. If so, replace the print cartridge.</p> <hr/> <p>Print the Supplies Status page to check the remaining life. See <a href="#">Supplies Status page</a>.</p>
<p>Toner specks appear.</p> 	<p>The media might not meet HP specifications.</p> <hr/> <p>The paper path might need cleaning.</p>	<p>Use media that meets HP specifications.</p> <hr/> <p>Clean the paper path. See the HP ToolboxFX online Help.</p>
<p>Dropouts appear.</p> 	<p>A single sheet of print media might be defective.</p> <hr/> <p>The moisture content of the paper is uneven or the paper has moist spots on its surface.</p> <hr/> <p>The paper lot is flawed. The manufacturing processes can cause some areas to reject toner.</p>	<p>Try reprinting the job.</p> <hr/> <p>Try different paper, such as high-quality paper that is intended for color laser printers.</p> <hr/> <p>Try different paper, such as high-quality paper that is intended for color laser printers.</p>
<p>Vertical streaks or bands appear on the page.</p> 	<p>One or more print cartridges might be low or defective. If you are using non-HP print cartridges, no messages appear on the printer control panel or in the HP ToolboxFX.</p>	<p>Replace any low print cartridges.</p>

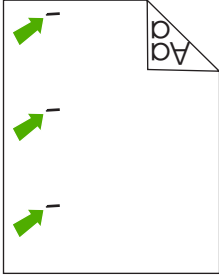
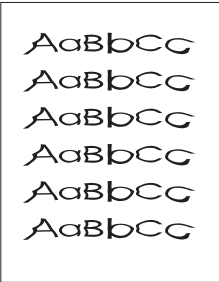
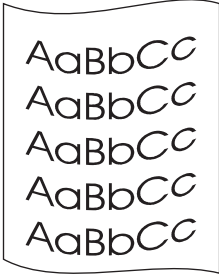

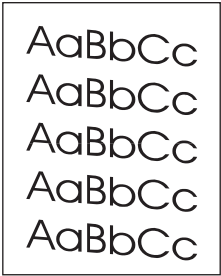
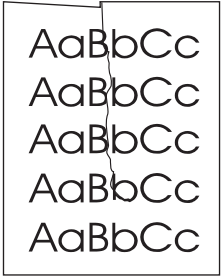
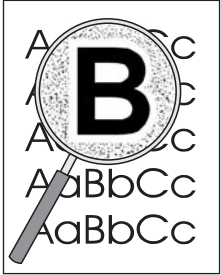
Problem	Cause	Solution
<p>The amount of background toner shading becomes unacceptable.</p> 	<p>The media might not meet HP specifications.</p>	<p>Use a different paper with a lighter basis weight.</p>
	<p>Very dry (low humidity) conditions can increase the amount of background shading.</p>	<p>Check the printer environment.</p>
	<p>One or more print cartridges might be low. If you are using non-HP print cartridges, no messages appear on the printer control panel or in the HP ToolboxFX.</p>	<p>Replace any low print cartridges.</p>
<p>Toner smears appear on the media.</p> 	<p>The media might not meet HP specifications.</p>	<p>Use media that meets HP specifications.</p>
	<p>If toner smears appear on the leading edge of the paper, the media guides are dirty, or debris has accumulated in the print path.</p>	<p>Clean the media guides and the paper path.</p>
<p>The toner smears easily when touched.</p> 	<p>The printer is not set to print on the type of media on which you want to print.</p>	<p>In the printer driver, select the <b>Paper</b> tab and set <b>Type is</b> to match the type of media on which you are printing. Print speed might be slower if you are using heavy paper.</p>
	<p>The media might not meet HP specifications.</p>	<p>Use media that meets HP specifications.</p>
	<p>The paper path might need cleaning.</p>	<p>Clean the printer.</p>
<p>Marks repeatedly appear at even intervals on the printed side of the page.</p> 	<p>The printer is not set to print on the type of media on which you want to print.</p>	<p>In the printer driver, select the <b>Paper</b> tab and set <b>Type is</b> to match the type of paper on which you are printing. Print speed might be slower if you are using heavy paper.</p>
	<p>Internal parts might have toner on them.</p>	<p>The problem typically corrects itself after a few more pages.</p>
	<p>The paper path might need cleaning.</p>	<p>Clean the printer.</p>
	<p>The fuser might be damaged or dirty.</p>	<p>Clean using instructions in HP ToolboxFX.</p>
		<p>Contact HP Customer Care. See <a href="#">HP Customer Care</a> or the support flyer that came in the printer box.</p>



Problem	Cause	Solution
	A print cartridge may have a problem.	To determine which cartridge has a problem, print the PQ diagnostics page from HP ToolboxFX.
<p>Marks repeatedly appear at even intervals on the unprinted side of the page.</p> 	Internal parts might have toner on them.	The problem typically corrects itself after a few more pages.
	The paper path might need cleaning.	Clean the printer.
	The fuser might be damaged or dirty.	Clean using instructions in HP ToolboxFX.  Contact HP Customer Care. See <a href="#">HP Customer Care</a> or the support flyer that came in the printer box.
<p>The printed page contains misformed characters.</p> 	The media might not meet HP specifications.	Use a different paper, such as high-quality paper that is intended for color laser printers.
	If characters are incorrectly formed so that they produce a wavy effect, the laser scanner might need service.	Verify that the problem also occurs on the Configuration page. If so, contact HP Customer Care. See <a href="#">HP Customer Care</a> or the support flyer that came in the printer box.
<p>The printed page is curled or wavy.</p> 	The printer is not set to print on the type of media on which you want to print.	In the printer driver, select the <b>Paper</b> tab and set <b>Type is</b> to match the type of paper on which you are printing. Print speed might be slower if you are using heavy paper.
	The media might not meet HP specifications.	Use a different paper, such as high-quality paper that is intended for color laser printers.
	Both high temperature and humidity can cause paper curl.	Check the printer environment.
<p>Text or graphics are skewed on the printed page.</p>	The media might be loaded incorrectly.	Make sure that the paper or other print media is loaded correctly and that the media guides are not too tight or too loose against the stack. See <a href="#">Loading trays</a> .
	The media might not meet HP specifications.	Use a different paper, such as high-quality paper that is intended for color laser printers.

Problem	Cause	Solution
		
<p>The printed page contains wrinkles or creases.</p> 	<p>The media might be loaded incorrectly.</p>	<p>Verify that the media is loaded correctly and that the media guides are not too tight or too loose against the stack. See <a href="#">Loading trays</a>.</p> <p>Turn over the stack of paper in the input tray, or try rotating the paper 180° in the input tray.</p>
<p>Toner appears around the printed characters.</p> 	<p>The media might not meet HP specifications.</p>	<p>Use a different paper, such as high-quality paper that is intended for color laser printers.</p>
<p>An image that appears at the top of the page (in solid black) repeats farther down the page (in a gray field).</p> 	<p>The media might be loaded incorrectly.</p> <p>If large amounts of toner have scattered around the characters, the paper might have high resistivity.</p>	<p>Turn over the stack of paper in the tray.</p> <p>Use a different paper, such as high-quality paper that is intended for color laser printers.</p>

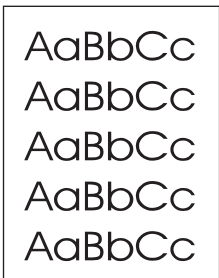
## Solving issues with color documents

This section describes issues that can occur when you print in color.

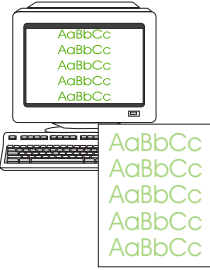
Problem	Cause	Solution
Only black is printing when the document should be printing in color.	Color mode is not selected in your program or printer driver.	Select color mode instead of grayscale mode.
	The correct printer driver might not be selected in the program.	Select the correct printer driver.
	The printer might not be correctly configured.	Print a Configuration page. If no color appears on the Configuration page, contact HP Customer Care. See <a href="#">HP Customer Care</a> or the support flyer that came in the printer box.
	Sealing tape might be on the print cartridges.	Verify that the sealing tape has been completely removed from the print cartridges.
	The media might not meet HP specifications.	Use a different paper, such as high-quality paper that is intended for color laser printers.
	The printer might be operating in excessively humid conditions.	Verify that the printer environment is within humidity specifications.
	One or more print cartridges might be low. If you are using non-HP print cartridges, no messages appear on the printer control panel or in the HP ToolboxFX.	Replace any low print cartridges.
	The control panel is set for override.	Replace low or empty print cartridges.
	A color is printing inconsistently after you load a new print cartridge.	Another print cartridge might be low. If you are using a non-HP print cartridge, it might be low or empty but you will receive no indication.
	The control panel is set for override.	Replace low or empty print cartridges.
	The colors on the printed page do not match the colors as they appear on the screen.	The colors on your computer monitor might differ from the printer output.
	If extremely light colors or extremely dark colors on screen are not printing, your software program might interpret extremely light colors as white or extremely dark colors as black.	If possible, avoid using extremely light or extremely dark colors.

Problem	Cause	Solution
	The media might not meet HP specifications.	Use a different paper, such as high-quality paper that is intended for color laser printers.
<p>The finish on the printed color page is inconsistent.</p> 	The media might be too rough.	Use a smooth paper or print media, such as a high-quality paper that is made for color laser printers. Generally, smoother media produces better the results.

## Media-handling problems

Use the information in this section when the printer experiences media-handling problems.

### Print-media guidelines

- For best results, make sure that the paper is of good quality, and free of cuts, nicks, tears, spots, loose particles, dust, wrinkles, voids, staples, and curled or bent edges.
- For best-quality color printing, use a smooth type of paper. Generally, smoother media produces better results.
- If you are unsure what type of paper you are loading (such as bond or recycled), check the label on the package of paper.
- Do not use media that is designed for Inkjet printers only. Use media that is designed for color LaserJet printers.
- Do not use letterhead paper that is printed with low-temperature inks, such as those used in some types of thermography.
- Do not use raised or embossed letterhead.
- The printer uses heat and pressure to fuse toner to the paper. Make sure that any colored paper or preprinted forms use inks that are compatible with this fusing temperature 210°C (410°F) for 0.2 second).



**CAUTION** Failure to follow these guidelines could cause jams or damage to the printer.

## Solving print-media problems

The following problems with paper cause print quality deviations, jamming, or even damage to the printer.

Problem	Cause	Solution
Poor print quality or toner adhesion	The paper is too moist, too rough, too heavy or too smooth, or it is embossed or from a faulty paper lot.	Verify that the appropriate media type was selected in the printer driver.  Try another kind of paper, between 100 and 250 Sheffield, 4% to 6% moisture content.
	Dropouts, jamming, or curl	The paper has been stored incorrectly.  The paper has variability from one side to the other.
Excessive curl	The paper is too moist, has the wrong grain direction, or is of short-grain construction.	Verify that the appropriate media type was selected in the printer driver.  Try printing on media from a new or different package.  Use long-grain paper.
	The paper varies from side-to-side.	Turn the paper over.
Jamming, damage to printer	The paper has cutouts or perforations.	Use paper that is free of cutouts or perforations.
Problems with feeding	The paper has ragged edges.	Use high-quality paper that is made for color laser printers.
	The paper varies from side-to-side.	Turn the paper over.
	The paper is too moist, too rough, too heavy or too smooth, has the wrong grain direction, or is of short-grain construction or it is embossed or from a faulty paper lot.	Try another kind of paper, between 100 and 250 Sheffield, 4 to 6% moisture content.  Use long-grain paper.
Print is skewed (crooked)	The media guides might be incorrectly adjusted.	Remove all media from the input tray, straighten the stack, and then load the media in the input tray again. Adjust the media guides to the width and length of the media that you are using and try printing again.
More than one sheet feeds at one time.	The media tray might be overloaded.	Remove some of the media from the tray. See <a href="#">Loading trays</a> .
	The media might be wrinkled, folded, or damaged.	Verify that the media is not wrinkled, folded, or damaged. Try printing on media from a new or different package.
Printer does not pull media from the media input tray.	The printer might be in manual feed mode.	<ul style="list-style-type: none"> <li>• If <b>Manual feed</b> appears on the printer control-panel display, press the  (<b>Select</b>) button to print the job.</li> <li>• Verify that the printer is not in manual feed mode and print your job again.</li> </ul>

Problem	Cause	Solution
	The media tray might be overloaded.	Remove some of the media from the tray. See <a href="#">Loading trays</a> .
	The paper-length adjustment control in Tray 2 or optional Tray 3 is set at a length that is greater than the media size.	Adjust the paper-length adjustment control to the correct length.
	The pickup roller might be dirty or damaged.	Contact HP Customer Care. See <a href="#">HP Customer Care</a> or the support flyer that came in the printer box.

## Performance problems

Try the tips in this section if pages exit the printer, but have nothing printed on them, or when the printer does not print any pages.

Problem	Cause	Solution
Pages print but are totally blank.	The sealing tape might still be in the print cartridges.	Verify that the sealing tape has been completely removed from the print cartridges.
	The document might contain blank pages.	Check the document that you are printing to see if content appears on all of the pages.
	The printer might be malfunctioning.	To check the printer, print a Configuration page.
Pages print very slowly.	Heavier media types can slow the print job.	Print on a different type of media.
	Complex pages will print slower	Proper fusing may require a slower print speed to ensure the best print quality.
Pages did not print.	The printer might not be pulling media correctly.	See <a href="#">Media-handling problems</a> .
	The media is jamming in the printer.	Clear the jam.
	The USB cable might be defective or incorrectly connected.	<ul style="list-style-type: none"> <li>● Disconnect the USB cable at both ends and reconnect it.</li> <li>● Try printing a job that has printed in the past.</li> <li>● Try using a different USB cable.</li> </ul>
	Other devices are running on your computer.	The device might not share a USB port. If you have an external hard drive or network switchbox that is connected to the same port as the printer, the other device might be interfering. To connect and use the printer, you must disconnect the other device or you must use two USB ports on the computer.



# Troubleshooting tools

The section describes the tools that can help you solve problems with your printer.

## Device pages and reports

This section describes the pages and reports that help you diagnose and solve problems with the printer.

### Demo page

To verify that your printer is functioning properly, print a Demo page. For more information about the Demo page, see [Demo page](#).

### Configuration page

The Configuration page lists the current settings and properties of the printer. You can use this page to check for color plane registration and cartridge half tones. You can print a Configuration page from the printer or HP ToolboxFX.

For more information about the Configuration page, see [Configuration page](#).

### Supplies Status page

The Supplies Status page lists the remaining life of the HP print cartridges. It also lists the estimated pages remaining, number of pages printed, and other supplies information. You can print a Supplies Status page from the printer or HP ToolboxFX.

For more information about the Supplies Status page, see [Supplies Status page](#).

## HP ToolboxFX

HP ToolboxFX is a software application that you can use for troubleshooting tasks.

### To view HP ToolboxFX

Open HP ToolboxFX in one of these ways:

- On the Windows desktop, double-click the HP ToolboxFX icon.
- On the Windows **Start** menu, click **Programs (All Programs** in Windows XP), click **HP**, click **HP Color LaserJet 2605 series**, and then click **HP ToolboxFX**.

### Troubleshooting tab

HP ToolboxFX includes a **Troubleshooting** tab that contains links to the following main pages:

- **Control Panel Messages**. View descriptions of printer control-panel messages.
- **Clearing Jams**. View information about locating and clearing jams.
- **Print Problems**. View Help topics that can help you solve print problems.
- **Memory Card Problems**. View Help topics that can help you solve memory-card problems.

- **Connectivity Problems.** View Help topics that can help you solve networking problems.
- **Troubleshooting Tools.** Employ such troubleshooting tools as a cleaning page or a color troubleshooting page to maintain the printer.



**NOTE** Other tabs on HP ToolboxFX might be helpful in troubleshooting printer problems. For information about the other tabs on HP ToolboxFX, see [HP ToolboxFX](#).

## Service menu

Use the control-panel **Service** menu to troubleshoot printer problems.

### Restoring the factory-set defaults

Restoring the factory-set defaults returns all of the settings to the factory defaults.

#### To restore the factory-set defaults

1. Use the (Left arrow) or the (Right arrow) button to select **Service**, and then press (Select).
2. Use the (Left arrow) or the (Right arrow) button to select **Restore defaults**, and then press (Select).

The printer automatically restarts.

### Cleaning the paper path

The printer features a special cleaning mode to clean the paper path.



**NOTE** If you have access to HP ToolboxFX, HP recommends cleaning the paper path by using HP ToolboxFX.

#### To clean the paper path

1. Use the (Left arrow) or the (Right arrow) button to select **Service**, and then press (Select).
2. Use the (Left arrow) or the (Right arrow) button to select **Cleaning Mode**, and then press (Select).

A page feeds through the printer slowly. Discard the page when the process is completed.

3. Load plain letter or A4 paper when you are prompted.
4. Press (Select) again to confirm and begin the cleaning process.

A page feeds through the printer slowly. Discard the page when the process is completed.

### Calibrating the printer

Calibrations are performed at regular intervals. For best print quality, a calibration can be performed from the control panel. For more information about calibrating the printer, see [Calibrating the printer](#).

# 13 Working with memory

This section provides information about the following topics:



- [Printer memory](#)
- [Installing memory and font DIMMs](#)
- [Checking DIMM installation](#)
- [Enabling memory](#)
- [Enabling the language-font DIMM for Windows](#)

## Printer memory

The HP Color LaserJet 2605dn and 2605dtn printer has one dual inline memory module (DIMM) slot for upgrading the printer capabilities with the following options:

- More printer memory. DIMMs are available in 32, 64, and 128 MB for a maximum of 192 MB.
- DIMM-based accessory fonts, macros, and patterns



You might want to add more memory to the printer if you often print complex graphics or PS documents, or use many downloaded fonts. Additional memory also allows the printer to print multiple, collated copies at the maximum speed.

Before ordering additional memory, see how much is currently installed by printing a Configuration page. Press  (Select) and  (Cancel Job) simultaneously, or use the HP ToolboxFX. To order DIMMs, see [Accessories and ordering information](#). Single inline memory modules (SIMMs) used on previous HP LaserJet printers are not compatible with the printer.

## Installing memory and font DIMMs

You can install more memory for the printer, and you can also install a font DIMM to print characters for languages such as Chinese, or for the Cyrillic alphabet.

**CAUTION** Static electricity can damage DIMMs. When handling DIMMs, wear an antistatic wrist strap, or frequently touch the surface of the DIMM antistatic package and then touch bare metal on the printer.

1. Print a Configuration page by pressing  (Select) and  (Cancel Job) simultaneously. (A Supplies Status page and possibly an HP Jetdirect Configuration page also print.) If the Configuration page does not print in your language, see [Device pages and reports](#).
2. After the Configuration page prints, turn the printer off and disconnect the power cable.

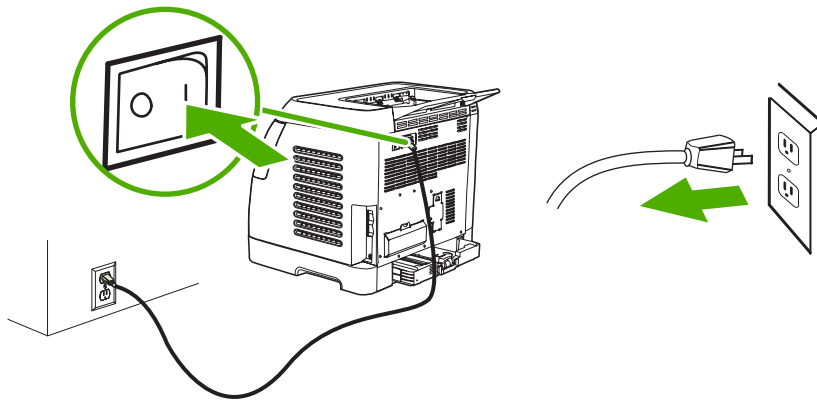

3. On the left rear side of the printer, open the DIMM door.

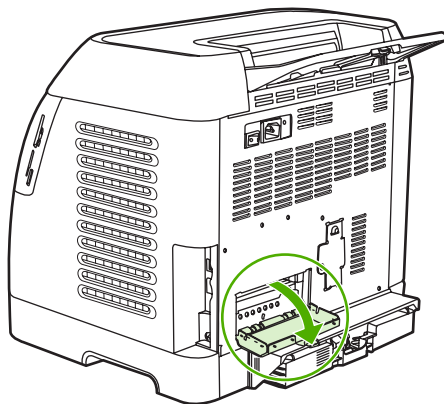

4. Release the locks on each side of the DIMM slot.

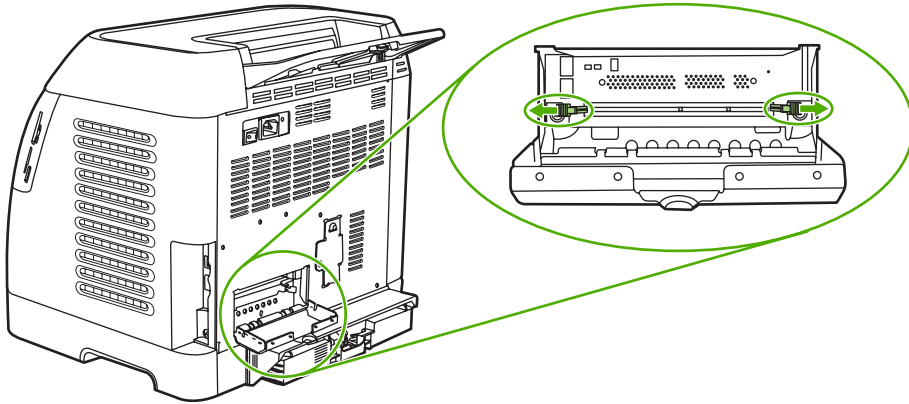

5. Remove the DIMM from the antistatic package.

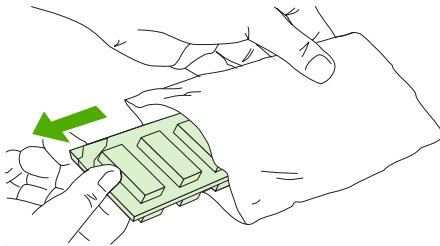

6. Holding the DIMM by the edges as shown in the illustration, align the notches on the DIMM with the DIMM slot.

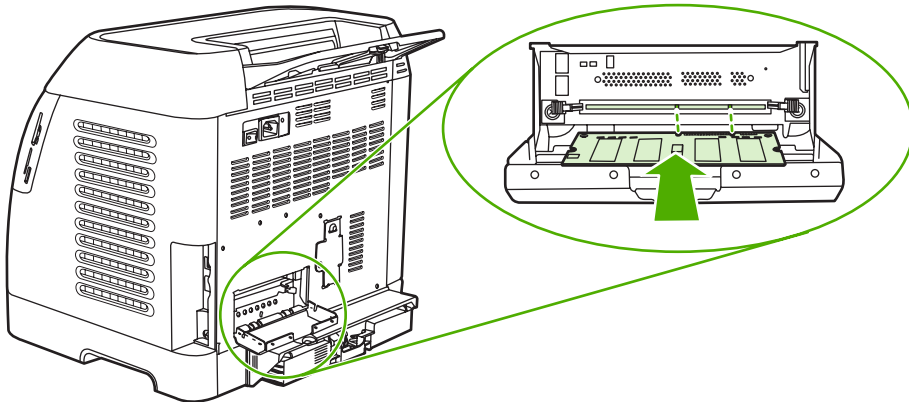

7. Firmly press the DIMM straight into the slot. Firmly close the locks on each side of the DIMM until they snap into place.

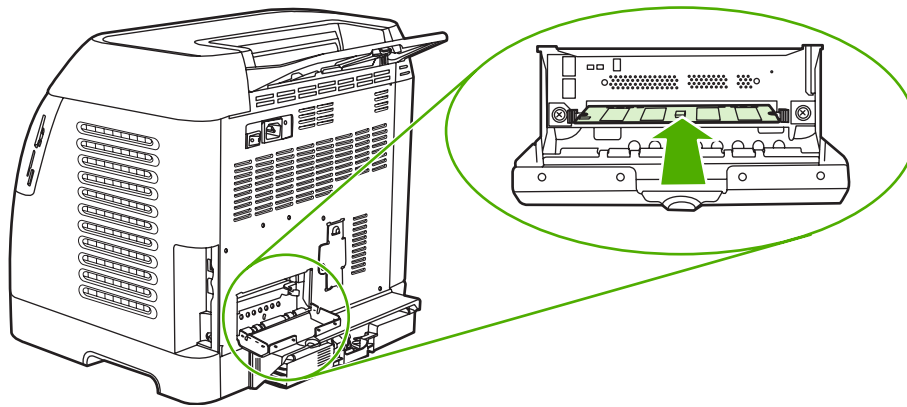

8. Close the DIMM door.

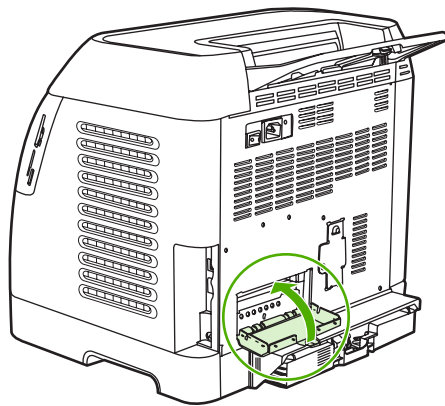

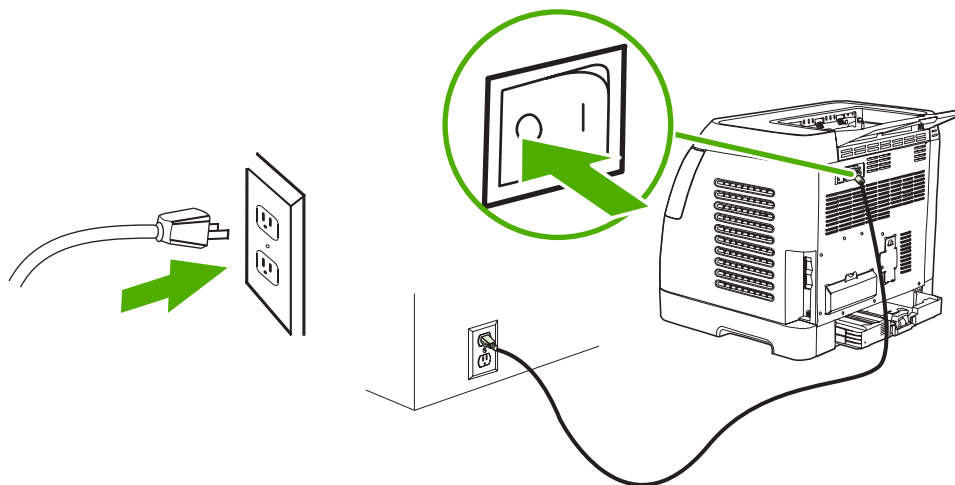

9. Reconnect the power cable and turn the printer on.



10. Go to [Checking DIMM installation](#).

## Checking DIMM installation

Check that the DIMMs are installed correctly and working.

1. Turn the printer on. Check that the Ready light is on after the printer has completed the startup sequence. If an error message appears, a DIMM might have been incorrectly installed.
2. Print a Configuration page by pressing  (Select) and  (Cancel Job) simultaneously. (A Supplies Status page and possibly an HP Jetdirect Configuration page also print.)
3. Check the Installed Personalities and Options section on the Configuration page and compare it with the Configuration page printed before the DIMM installation.
4. If the amount of recognized memory has not increased or the font DIMM is not recognized, the following conditions might exist:
  - The DIMM might not be installed correctly. Repeat the installation procedure.
  - The DIMM might be defective. Try installing a different DIMM.
5. After you have installed the DIMM correctly, go to [Enabling memory](#) if you installed a memory DIMM or [Enabling the language-font DIMM for Windows](#) if you installed a language-font DIMM.



## Enabling memory

If the printer has a new memory DIMM installed, all Windows users of the printer must set the printer driver to recognize the newly added memory. Macintosh computers automatically recognize new memory.

### To enable memory for Windows

1. On the **Start** menu, point to **Settings**, and click **Printers** or **Printers and Faxes**.
2. Select this printer and select **Properties**.
3. On the **Configure** tab, click **More**.
4. In the **Total Memory** field, type the total amount of memory that is now installed.
5. Click **OK**.

## Enabling the language-font DIMM for Windows

If the printer has a new language-font DIMM installed, all Windows users of the printer must set the printer driver to recognize the newly installed font DIMM. Macintosh computers automatically recognize new language font DIMMs.

1. On the **Start** menu, point to **Settings**, and click **Printers**.
2. Select this printer and select **Properties**.
3. On the **Configure** tab, click **More**.
4. Select the **Font DIMM** check box.
5. Click **OK**.

# A Accessories and ordering information

The lists of accessories in this section was current at the time of printing. Ordering information and availability of the accessories might change during the life of the printer. For the most current ordering information, visit <http://www.hp.com>.

- [Supplies](#)
- [Memory](#)
- [Cable and interface accessories](#)
- [Paper handling accessories](#)
- [Paper and other print media](#)
- [User-replaceable parts](#)
- [Supplementary Documentation](#)

# Supplies

Product name	Description	Part number
Black print cartridge	Life of 2,500 pages at approximately 5% coverage.	Q6000A
Cyan print cartridge	Life of 2,000 pages at approximately 5% coverage.	Q6001A
Yellow print cartridge	Life of 2,000 pages at approximately 5% coverage.	Q6002A
Magenta print cartridge	Life of 2,000 pages at approximately 5% coverage.	Q6003A



**NOTE** Actual yields may vary according to usage.

# Memory

Product name	Description	Part number
Memory upgrades (DIMMs)	The standard 64 MB of memory in the printer can be expanded to up to 192 MB using the additional DIMM slot.  32 MB	C7845A
Memory upgrades (DIMMs)	64 MB	Q1887A
Memory upgrades (DIMMs)	128 MB	C9121A
Font DIMM (100-pin)	You can install an 8 MB language font ROM in the DIMM slot.	Visit <a href="http://www.hp.com">http://www.hp.com</a> for DIMM availability and ordering.

## Cable and interface accessories

Product name	Description	Part number
USB cable	2-meter standard USB-compatible device connector	C6518A

## Paper handling accessories

Product name	Description	Part number
Optional Tray 3	Optional 250-sheet universal input tray (included with the HP Color LaserJet 2605dtn). Only one optional 250-sheet tray can be installed.	Q6459A

## Paper and other print media

Product name	Description	Part number
HP LaserJet paper	Premium HP-brand paper for use with HP LaserJet printers.	HPJ1124 (letter)
HP LaserJet paper	Premium HP-brand paper for use with HP LaserJet printers.	CHP310 (A4)
HP LaserJet paper	Premium HP-brand paper for use with HP LaserJet printers.	HPJ1424 (legal)
HP Premium Choice paper	HP bond paper with a weight of 120.32 g/m <sup>2</sup> (32 lb).	HPU1132 (letter)
HP Premium Choice paper	HP bond paper with a weight of 120.32 g/m <sup>2</sup> (32 lb).	CHP410 (A4)
HP Cover paper	HP-brand paper with a weight of 200 g/m <sup>2</sup> (75 lb) cover. Use for printing postcards and document covers.	Q2413A (letter) 100 sheets
HP Cover paper	HP-brand paper with a weight of 200 g/m <sup>2</sup> (75 lb) cover. Use for printing postcards and document covers.	Q2414A (A4) 100 sheets
HP Printing paper	HP-brand paper for use with HP LaserJet printers.	HPP1122 (letter)
HP Printing paper	HP-brand paper for use with HP LaserJet printers.	CHP210 (A4)
HP Multipurpose paper	HP-brand paper for a variety of uses.	HPM1120 (letter)
HP Multipurpose paper	HP-brand paper for a variety of uses.	HPM1420 (legal)
HP LaserJet Tough paper	Robust paper with a satin finish. Paper will not tear and will withstand the weather. For documents requiring durability and longevity.	Q1298A (letter)
HP LaserJet Tough paper	Robust paper with a satin finish. Paper will not tear and will withstand the weather. For documents requiring durability and longevity.	Q1298B (A4)
HP Glossy Photo & Imaging laser paper	High-gloss finish coating on both sides. Use for brochures, catalogs, photographs, and whenever a high-gloss finish is desired.	Q6545A (letter) 200 sheets
HP Laser Photo Paper, Glossy	High-gloss finish coating on both sides. Use for brochures, catalogs, photographs, and whenever a high-gloss finish is desired.	Q6547A (A4) 200 sheets
HP Soft Gloss Presentation laser paper	Satin finish coating on both sides. 120 g/m <sup>2</sup> (32 lb)	Q6541A (letter) 200 sheets
HP Laser Paper, Soft Gloss	Satin finish coating on both sides. 120 g/m <sup>2</sup> (32 lb)	C6542A (A4) 200 sheets
HP Soft Gloss laser paper	Satin finish coating on both sides. 105 g/m <sup>2</sup> (28 lb)	Q2415A (letter) 500 sheets



Product name	Description	Part number
HP Soft Gloss laser paper	Satin finish coating on both sides. 105 g/m <sup>2</sup> (28 lb)	Q2417A (A4) 500 sheets
HP Color LaserJet transparencies	Use color transparencies for full-color printing.	C2934A (letter) 50 sheets
HP Color LaserJet transparencies	Use color transparencies for full-color printing.	C2936A (A4) 50 sheets
HP Matte Photo & Imaging laser paper	Matte finish paper for photos and imaging. 120 g/m <sup>2</sup> (32 lb)	Q6549A (letter) 100 sheets
HP Laser Photo paper, Matte	Matte finish paper for photos and imaging. 120 g/m <sup>2</sup> (32 lb)	Q6550A (A4) 100 sheets
HP Matte Brochure laser paper	Matte finish paper. Use for brochures, catalogs, and so on 160 g/m <sup>2</sup> (52 lb)	Q6543A (letter) 150 sheets
HP Laser Paper, Matte	Matte finish paper. Use for brochures, catalogs, and so on. 160 g/m <sup>2</sup> (52 lb)	Q6544A (A4) 150 sheets

## User-replaceable parts

Product name	Description	Part number
Separation pad and pick-up rollers	Replace when the printer is picking up multiple sheets or no sheets. Trying different paper did not resolve the problem.	Q5956-67902
Paper tray	A 250-sheet paper tray cassette.	Q5956-67901
Dust cover	Protects the output of paper cassette from dust.	Q5956-67903
Output tray extender	An extension for supporting paper in the output bin.	Q5956-67904

## Supplementary Documentation

A printed copy of this user guide is available in the following languages.

**Table A-1** User guides

Language	Part number
English	Q7821-90906
Arabic	Q7821-90907
Catalan	Q7821-90908
Chinese (Simplified)	Q7821-90923
Chinese (Traditional)	Q7821-90926
Czech	Q7821-90909
Danish	Q7821-90910
Dutch	Q7821-90911
Finnish	Q7821-90912
French	Q7821-90913
German	Q7821-90914
Hebrew	Q7821-90915
Hungarian	Q7821-90916
Indonesian (Bahasa)	Q7821-90929
Italian	Q7821-90917
Korean	Q7821-90918
Norwegian	Q7821-90919
Portuguese (Brazilian)	Q7821-90921
Polish	Q7821-90920
Russian	Q7821-90922
Spanish	Q7821-90924
Swedish	Q7821-90925
Thai	Q7821-90927
Turkish	Q7821-90928



## **B Service and support**

# Hewlett-Packard limited warranty statement

## HP PRODUCT

HP Color LaserJet 2605 series

## DURATION OF LIMITED WARRANTY

1 year, Limited Warranty

HP warrants to you, the end-user customer, that HP hardware and accessories will be free from defects in materials and workmanship after the date of purchase, for the period specified above. If HP receives notice of such defects during the warranty period, HP will, at its option, either repair or replace products which prove to be defective. Replacement products may be either new or equivalent in performance to new.

HP warrants to you that HP software will not fail to execute its programming instructions after the date of purchase, for the period specified above, due to defects in material and workmanship when properly installed and used. If HP receives notice of such defects during the warranty period, HP will replace software which does not execute its programming instructions due to such defects.

HP does not warrant that the operation of HP products will be uninterrupted or error free. If HP is unable, within a reasonable time, to repair or replace any product to a condition as warranted, you will be entitled to a refund of the purchase price upon prompt return of the product.

HP products may contain remanufactured parts equivalent to new in performance or may have been subject to incidental use.

Warranty does not apply to defects resulting from (a) improper or inadequate maintenance or calibration, (b) software, interfacing, parts or supplies not supplied by HP, (c) unauthorized modification or misuse, (d) operation outside of the published environmental specifications for the product, or (e) improper site preparation or maintenance.

TO THE EXTENT ALLOWED BY LOCAL LAW, THE ABOVE WARRANTIES ARE EXCLUSIVE AND NO OTHER WARRANTY OR CONDITION, WHETHER WRITTEN OR ORAL, IS EXPRESSED OR IMPLIED AND HP SPECIFICALLY DISCLAIMS ANY IMPLIED WARRANTIES OR CONDITIONS OF MERCHANTABILITY, SATISFACTORY QUALITY, AND FITNESS FOR A PARTICULAR PURPOSE. Some countries/regions, states or provinces do not allow limitations on the duration of an implied warranty, so the above limitation or exclusion might not apply to you. This warranty gives you specific legal rights and you might also have other rights that vary from country/region to country/region, state to state, or province to province. HP's limited warranty is valid in any country/region or locality where HP has a support presence for this product and where HP has marketed this product. The level of warranty service you receive may vary according to local standards. HP will not alter form, fit or function of the product to make it operate in a country/region for which it was never intended to function for legal or regulatory reasons.

TO THE EXTENT ALLOWED BY LOCAL LAW, THE REMEDIES IN THIS WARRANTY STATEMENT ARE YOUR SOLE AND EXCLUSIVE REMEDIES. EXCEPT AS INDICATED ABOVE, IN NO EVENT WILL HP OR ITS SUPPLIERS BE LIABLE FOR LOSS OF DATA OR FOR DIRECT, SPECIAL, INCIDENTAL, CONSEQUENTIAL (INCLUDING LOST PROFIT OR DATA), OR OTHER DAMAGE, WHETHER BASED IN CONTRACT, TORT, OR OTHERWISE. Some countries/regions, states or provinces do not allow the exclusion or limitation of incidental or consequential damages, so the above limitation or exclusion may not apply to you.

THE WARRANTY TERMS CONTAINED IN THIS STATEMENT, EXCEPT TO THE EXTENT LAWFULLY PERMITTED, DO NOT EXCLUDE, RESTRICT OR MODIFY AND ARE IN ADDITION TO THE MANDATORY STATUTORY RIGHTS APPLICABLE TO THE SALE OF THIS PRODUCT TO YOU.

# Print Cartridge Limited Warranty Statement

This HP product is warranted to be free from defects in materials and workmanship.

This warranty does not apply to products that (a) have been refilled, refurbished, remanufactured or tampered with in any way, (b) experience problems resulting from misuse, improper storage, or operation outside of the published environmental specifications for the printer product or (c) exhibit wear from ordinary use.

To obtain warranty service, please return the product to place of purchase (with a written description of the problem and print samples) or contact HP Customer Support. At HP's option, HP will either replace products that prove to be defective or refund your purchase price.

TO THE EXTENT ALLOWED BY LOCAL LAW, THE ABOVE WARRANTY IS EXCLUSIVE AND NO OTHER WARRANTY OR CONDITION, WHETHER WRITTEN OR ORAL, IS EXPRESSED OR IMPLIED AND HP SPECIFICALLY DISCLAIMS ANY IMPLIED WARRANTIES OR CONDITIONS OF MERCHANTABILITY, SATISFACTORY QUALITY, AND FITNESS FOR A PARTICULAR PURPOSE.

TO THE EXTENT ALLOWED BY LOCAL LAW, IN NO EVENT WILL HP OR ITS SUPPLIERS BE LIABLE FOR DIRECT, SPECIAL, INCIDENTAL, CONSEQUENTIAL (INCLUDING LOST PROFIT OR DATA), OR OTHER DAMAGE, WHETHER BASED IN CONTRACT, TORT, OR OTHERWISE.

THE WARRANTY TERMS CONTAINED IN THIS STATEMENT, EXCEPT TO THE EXTENT LAWFULLY PERMITTED, DO NOT EXCLUDE, RESTRICT OR MODIFY AND ARE IN ADDITION TO THE MANDATORY STATUTORY RIGHTS APPLICABLE TO THE SALE OF THIS PRODUCT TO YOU.

# HP Customer Care

## Online services

*for 24-hour access to information by using a modem or Internet connection*

World Wide Web: Updated HP printer software, product and support information, and printer drivers in several languages can be obtained from <http://www.hp.com/support/clj2605>. (The site is in English.)

## Online troubleshooting tools

HP Instant Support Professional Edition (ISPE) is a suite of Web-based troubleshooting tools for desktop computing and printing products. ISPE helps you quickly identify, diagnose, and resolve computing and printing problems. The ISPE tools can be accessed from <http://instantsupport.hp.com>.

## Telephone support

Hewlett-Packard provides free telephone support during the warranty period. When you call, you will be connected to a responsive team that is waiting to help you. For the telephone number for your country/region, see the flyer that came in the box with the product, or visit <http://www.hp.com> and then click **Contact HP**. Before calling HP, have the following information ready: product name and serial number, date of purchase, and description of the problem.

You can also find support on the Internet at <http://www.hp.com>. Click the **support & drivers** block.

## Software utilities, drivers, and electronic information

Go to [http://www.hp.com/go/clj2605\\_software](http://www.hp.com/go/clj2605_software). (The site is in English, but printer drivers can be downloaded in several languages.)

For information over the telephone, see the flyer that came in the box with the printer.

## HP direct ordering for accessories or supplies

Order supplies from the following websites:

North America: <https://www.hp.com/post-embed/ordersupplies-na>

Latin America: <https://www.hp.com/post-embed/ordersupplies-la>

Europe and Middle East: <https://www.hp.com/post-embed/ordersupplies-emea>

Asia Pacific countries/regions: <https://www.hp.com/post-embed/ordersupplies-ap>

Order accessories from <http://www.hp.com> and click **Supplies & Accessories**. For more information, see [Accessories and ordering information](#).

To order supplies or accessories over the telephone, call the following numbers:

United States: 1-800-538-8787

Canada: 1-800-387-3154

To find the telephone numbers for other countries/regions, see the flyer that came in the box with the printer.

## HP service information



To locate HP-Authorized Dealers in the United States or Canada, call 1-800-243-9816 (United States) or 1-800-387-3867 (Canada). Or, go to <http://www.hp.com/go/cposupportguide>.

For service for your HP product in other countries/regions, call the HP Customer Support telephone number for your country/region. See the flyer that came in the box with the printer.

### **HP service agreements**

Call: 1-800-HPINVENT [1-800-474-6836 (U.S.)] or 1-800-268-1221 (Canada).

Out-of-Warranty Service: 1-800-633-3600.

Extended Service: Call 1-800-HPINVENT 1-800-474-6836 (U.S.) or 1-800-268-1221 (Canada). Or, go to the HP Supportpack and Carepaq™ Services website at <http://www.hpexpress-services.com/10467a>.

### **HP ToolboxFX**

To check the printer status and settings and to view troubleshooting information and online documentation, use the HP ToolboxFX software. You can view the HP ToolboxFX when the printer is directly connected to your computer or when it is connected to a network. You must have performed a complete software installation to use the HP ToolboxFX. See [Managing the printer](#).

## Availability of support and service

Around the world, HP provides a variety of service and support options for purchase. Availability of these programs will vary depending upon your location.

### **HP Care Pack™ Services and Service Agreements**

HP has various service and support options that meet a wide range of needs. These options are not part of the standard warranty. Support services may vary by location. For most printers HP offers both in-warranty and post-warranty HP Care Pack Services and Service Agreements.

To identify service and support options for this printer go to <http://www.hpexpress-services.com/10467a> and type the printer model number. In North America, Service Agreement information can be obtained through HP Customer Care. Call 1-800-HPINVENT 1-800-474-6836 (U.S.) or 1-800-268-1221 (Canada). In other countries/regions please contact your country/region specific HP Customer Care Center. See the inbox flyer or go to <http://www.hp.com> for the HP Customer Care telephone number in your country/region.

# Repacking the printer

If your printer needs to be moved or shipped to another location, perform the following procedure to repack the printer.



---

**CAUTION** Shipping damage as a result of inadequate packing is the customer's responsibility. To ensure proper protection during shipment, the printer must be repackaged properly using the original cushions.

---

## To repack the printer



---

**CAUTION** It is *extremely important* to remove the print cartridges before shipping the printer. Print cartridges left in the printer during shipping will leak and entirely cover the printer engine and other parts with toner.

To prevent damage to the print cartridge, avoid touching the roller, and store the print cartridge in its original packing material or so that it is not exposed to light.

---

1. Remove all four print cartridges.
2. If you have added optional Tray 3, remove and retain.
3. Remove and retain the power cable and interface cable.
4. Remove and retain the optional HP Jetdirect external print server, if you have one.
5. If possible, include print samples and 50 to 100 sheets of paper or other print media that did not print correctly.
6. Use the original shipping container and packing material, if possible. If you have already disposed of the printer packing material, contact a local mailing service for information about repacking the printer. HP recommends insuring the equipment for shipment.
7. Include a completed copy of the [Service information form](#).
8. In the U.S., call HP Customer Care to request new packing material. In other areas, use the original packing material, if possible. Hewlett-Packard recommends insuring the equipment for shipment.

# Service information form

---

<b>WHO IS RETURNING THE EQUIPMENT?</b>		Date:
Person to contact:		Phone:
Alternate contact:		Phone:
Return shipping address:	Special shipping instructions:	

---

**WHAT ARE YOU SENDING?**

Model name:	Model number:	Serial number:
-------------	---------------	----------------

Please attach any relevant printouts. Do NOT ship accessories (manuals, cleaning supplies, and so on) that are not required to complete the repair.

---

**HAVE YOU REMOVED THE PRINT CARTRIDGES?**

You must remove them before shipping the printer, unless a mechanical problem prevents you from doing so.

Yes.  No, I cannot remove them.

---

**WHAT NEEDS TO BE DONE?** (Attach a separate sheet if necessary.)

1. Describe the conditions of the failure. (What was the failure? What were you doing when the failure occurred? What software were you running? Is the failure repeatable?)

---

2. If the failure is intermittent, how much time elapses between failures?

---

3. If the unit connected to any of the following, give the manufacturer and model number.

Personal computer:	Modem:	Network:
--------------------	--------	----------

4. Additional comments:

---

**HOW WILL YOU PAY FOR THE REPAIR?**

Under warranty  Purchase/received date:

(Attach proof of purchase or receiving document with original received date.)

Maintenance contract number:

Purchase order number:

---

**Except for contract and warranty service, a purchase order number and/or authorized signature must accompany any request for service.** If standard repair prices do not apply, a minimum purchase order is required. Standard repair prices can be obtained by contacting an HP-authorized repair center.

Authorized signature:	Phone:
Billing address:	Special billing instructions:

# C Specifications

This section contains information about printer specifications.

- [Printer specifications](#)

# Printer specifications

**Table C-1** Physical specifications

Product	Height	Depth	Width	Weight
HP Color LaserJet 2605 printer with consumables	370 mm (14.69 inches)	412 mm (16.24 inches)	407 mm (16.02 inches)	18.55 kg (40.91 lbs)
HP Color LaserJet 2605dn printer with consumables	395 mm (15.54 inches)	412 mm (16.24 inches)	407 mm (16.02 inches)	19.87 kg (43.82 lbs)
HP Color LaserJet 2605dtn printer with consumables and Tray 3	492 mm (19.36 inches)	412 mm (16.24 inches)	407 mm (16.02 inches)	23.63 kg (52.10 lbs)

**Table C-2** Supplies specifications

Print-cartridge life (based on approximately 5% coverage)	Black: 2,500 pages Yellow, cyan, and magenta: 2,000 pages each
---	---

**Table C-3** Electrical specifications

Item	110-Volt models	220-Volt models
<b>Power requirements<sup>1</sup></b>	115-127V (+/-10%) 50/60 Hz (+/- 2 Hz)	220-240V (+/-10%) 50/60 Hz (+/- 2 Hz)
<b>Rated current</b>	3.6 Amps	2.5 Amps
<b>Power consumption (average, in watts)</b>		
During printing (color) <sup>2</sup>	234 W (average)	234 W (average)
During printing (black and white) <sup>2</sup>	251 W (average)	251 W (average)
During standby	15 W (average)	15 W (average)
Off mode	0 W (average)	0 W (average)
<b>Heat output<sup>3</sup></b>	55 BTU/hour	55 BTU/hour
Ready Mode		

<sup>1</sup> Values subject to change, see <http://www.hp.com/support/clj2605> for current information.

<sup>2</sup> Power reported is highest values measured for color and monochrome printing using all standard voltages.

<sup>3</sup> Maximum heat dissipation for all models in Ready Mode = 55 BTU/Hour



**WARNING!** Power requirements are based on the country/region where the printer is sold. Do not convert operating voltages. This may damage the printer and void the product warranty.

**Table C-4** Environmental specifications

	Recommended <sup>1</sup>	Operating <sup>1</sup>	Storage <sup>1</sup>
(printer and print cartridge) Temperature	20° to 27°C (68° to 81°F)	15° to 32.5°C (59° to 90.5°F)	-20° to 40°C (-4° to 104°F)
Relative humidity	20% to 70%	10% to 80%	95% or less

<sup>1</sup> Values are subject to change. See <http://www.hp.com/support/clj2605> for current information.

**Table C-5** Acoustic emissions<sup>1</sup>

Sound Power Level	Declared per ISO 9296 <sup>1</sup>
Printing (12 ppm) <sup>2</sup>	$L_{WA} = 6.0$ Bels (A) [60 dB (A)]
Ready	Inaudible
Sound Pressure Level (SPL)-Bystander Position	Declared per ISO 9296 <sup>1</sup>
Printing (12 ppm) <sup>2</sup>	$L_{pAm} = 47$ dB(A)
Ready	Inaudible

<sup>1</sup> Values are subject to change. See <http://www.hp.com/support/clj2605> for current information.

<sup>2</sup> HP Color LaserJet 2605 series speed is 10 ppm for color and 12 ppm for monochrome.





# D Regulatory information

This section contains the following information:

- [Introduction](#)
- [FCC regulations](#)
- [Environmental Product Stewardship program](#)
- [Declaration of conformity](#)
- [Country/region-specific safety statements](#)

# Introduction

This section contains the following regulatory information:

- [FCC regulations](#)
- [Environmental Product Stewardship program](#)
- [Service and support](#)
- [Declaration of conformity](#)
- [Laser safety statement](#)
- [Canadian DOC statement](#)
- [Korean EMI statement](#)
- [VCCI statement \(Japan\)](#)
- [Finnish laser statement](#)

# FCC regulations

This equipment has been tested and found to comply with the limits for a Class B digital device, pursuant to Part 15 of the FCC rules. These limits are designed to provide reasonable protection against harmful interference in a residential installation. This equipment generates, uses, and can radiate radio frequency energy. If this equipment is not installed and used in accordance with the instructions, it may cause harmful interference to radio communications. However, there is no guarantee that interference will not occur in a particular installation; the presence of interference can be determined by turning the equipment off and on. If this equipment does cause harmful interference to radio or television communications, the user is encouraged to try to correct the interference by one or more of the following measures:

- Reorient or relocate the receiving antenna.
- Increase distance between equipment and receiver.
- Connect equipment to an outlet on a circuit different from that to which the receiver is located.
- Consult your dealer or an experienced radio/television technician.



**NOTE** Any changes or modifications to the printer that are not expressly approved by HP could void the user's authority to operate this equipment.

Use of a shielded interface cable is required to comply with the Class B limits of Part 15 of FCC rules.

---

# Environmental Product Stewardship program

## Protecting the environment

Hewlett-Packard Company is committed to providing quality products in an environmentally sound manner. This product has been designed with several attributes to minimize impacts on our environment.

## Ozone production

This product generates no appreciable ozone gas (O<sub>3</sub>).

## Power consumption

Power usage drops significantly while in sleep mode, which saves natural resources and saves money without affecting the high performance of this product. This product qualifies for ENERGY STAR® (Version 3.0), which is a voluntary program to encourage the development of energy-efficient office products.



ENERGY STAR® and the ENERGY STAR mark are U.S. registered marks. As an ENERGY STAR® partner, Hewlett-Packard Company has determined that this product meets ENERGY STAR® Guidelines for energy efficiency. For more information, see <http://www.energystar.gov/>.

## Paper use

This product's duplex feature (two-sided printing); see [Printing on both sides](#) and N-up printing [multiple pages printed on one page] capability can reduce paper usage and the resulting demands on natural resources.

## Plastics

Plastic parts over 25 grams are marked according to international standards that enhance the ability to identify plastics for recycling purposes at the end of the product's life.

## HP LaserJet printing supplies

It is easy to return and recycle your empty HP LaserJet print cartridges—free of charge—with HP Planet Partners. HP is committed to providing inventive, high-quality products and services that are environmentally sound, from product design and manufacturing to distribution, operation and recycling processes. We ensure your returned HP LaserJet print cartridges are recycled properly, processing them to recover valuable plastics and metals for new products and diverting millions of tons of waste from landfills. Since this cartridge is being recycled and used in new materials, it will not be returned to you. Your empty HP LaserJet print cartridges are recycled responsibly when you participate in the HP Planet Partners program. Thank you for being environmentally responsible!

In many countries/regions, this product's printing supplies (for example, print cartridge) can be returned to HP through the HP Printing Supplies Returns and Recycling Program. An easy-to-use and free takeback program is available in over 35 countries/regions. Multi-lingual program

information and instructions are included in every new HP LaserJet print cartridge and supplies package.

### **HP Printing Supplies Returns and Recycling Program Information**

Since 1992, HP has offered HP LaserJet supplies return and recycling free of charge. In 2004, HP Planet Partners for LaserJet Supplies was available in 85% of the world market where HP LaserJet supplies are sold. Postage-paid and pre-addressed labels are included within the instruction guide in most HP LaserJet print cartridge boxes. Labels and bulk boxes are also available through the website: <http://www.hp.com/recycle>.

Use the label to return empty, original HP LaserJet cartridges only. Please do not use this label for, non-HP cartridges, refilled or remanufactured cartridges or warranty returns. Printing supplies or other objects inadvertently sent to the HP Planet Partners program cannot be returned.

More than 10 million HP LaserJet print cartridges were recycled globally in 2004 through the HP Planet Partners supplies recycling program. This record number represents 26 million pounds of print cartridge materials diverted from landfills. Worldwide, in 2004, HP recycled an average of 59% of the print cartridge by weight consisting primarily of plastic and metals. Plastics and metals are used to make new products such as HP products, plastic trays and spools. The remaining materials are disposed of in an environmentally responsible manner.

#### **U.S. returns**

For a more environmentally responsible return of used cartridges and supplies, HP encourages the use of bulk returns. Simply bundle two or more cartridges together and use the single, pre-paid, pre-addressed UPS label that is supplied in the package. For more information in the U.S., call 1-800-340-2445 or visit the HP Printing Supplies Returns and Recycling Program website at: <http://www.hp.com/go/recycle>.

#### **Non-U.S. returns**

Non-U.S. customers should visit the <http://www.hp.com/go/recycle> website for further information regarding availability of the HP Supplies Returns and Recycling program.

#### **Paper**

This product is capable of using recycled papers, when the paper meets the guidelines outlined in the *HP LaserJet Printer Family Print Media Guide*. Go to <http://www.hp.com/support/ljpaperguide> to download this guide in PDF format. This product is suitable for the use of recycled paper according to EN12281:2002.

#### **Material restrictions**

This product does not contain added mercury.

This product does not contain batteries.

For recycling information, you can contact <http://www.hp.com/go/recycle> or contact your local authorities or the Electronics Industry Alliance at <http://www.eiae.org>.

### **Disposal of waste equipment by users in private households in the European Union**

This symbol on the product or on its packaging indicates that this product must not be disposed of with your other household waste. Instead, it is your responsibility to dispose of your waste equipment by handing it over to a designated collection point for the recycling of waste electrical and electronic equipment. The separate collection and recycling of your waste equipment at the time of disposal will

help to conserve natural resources and ensure that it is recycled in a manner that protects human health and the environment. For more information about where you can drop off your waste equipment for recycling, please contact your local city office, your household waste disposal service or the shop where you purchased the product.



## Material safety data sheet

Material Safety Data Sheets (MSDS) for supplies containing chemical substances, such as toner, can be obtained by contacting the HP website at <http://www.hp.com/go/msds> or <http://www.hp.com/hpinfo/community/environment/productinfo/safety>.

### Extended warranty

HP SupportPack provides coverage for the HP hardware product and all HP-supplied internal components. The hardware maintenance covers a three-year period from the date of the HP product purchase. The customer must purchase HP SupportPack within 90 days of the HP product purchase. For more information, contact the HP Customer Care Service and HP Customer Support Group. See [HP Customer Care](#).

### Spare parts and supplies availability

Spare parts and consumable supplies for this product will be available for at least five years after production has stopped.

### For more information

To obtain information about these environmental topics:

- Product environmental profile sheet for this and many related HP products
- HP's commitment to the environment
- HP's environmental management system
- HP's end-of-life product return and recycling program
- MSDS

See: <http://www.hp.com/go/environment> or <http://www.hp.com/hpinfo/community/environment/productinfo/safety>.

# Declaration of conformity

## Declaration of Conformity

according to ISO/IEC Guide 22 and EN 45014

**Manufacturer's Name:** Hewlett-Packard Company  
**Manufacturer's Address:** 11311 Chinden Boulevard,  
Boise, Idaho 83714-1021, USA

**declares, that the product**

**Product Name:** HP Color LaserJet 2605 Series  
**Regulatory Model Number<sup>3)</sup>:** BOISB-0409-02

**Product Options:** Including: Q6459A —Optional 250-Sheet Input Tray  
All  
**Toner Cartridges:** Q6000A, Q6001A, Q6002A, Q6003A

**conforms to the following Product Specifications:**

**Safety:** IEC 60950-1:2001 / EN60950-1:2001 +A11  
IEC 60825-1:1993 +A1 +A2/  
EN 60825-1:1994 +A1 +A2 (Class 1 Laser/LED Product)  
GB4943-2001

**EMC:** CISPR22:1993 +A1 +A2 / EN55022:1994 + A1 + A2 —1 Class B<sup>1)</sup>  
EN 61000-3-2:2000  
EN 61000-3-3:1995 +A1  
EN 55024:1998 +A1 +A2  
FCC Title 47 CFR, Part 15 Class B<sup>2)</sup> / ICES-003, Issue 4  
GB9254-1998, GB17625.1-2003

### Supplementary Information:

The product herewith complies with the requirements of the EMC Directive 89/336/EEC and the Low Voltage Directive 73/23/EEC, and carries the CE-Marking accordingly.

- 1) The product was tested in a typical configuration with Hewlett-Packard Personal Computer Systems.
- 2) This Device complies with Part 15 of the FCC Rules. Operation is subject to the following two Conditions: (1) this device may not cause harmful interference, and (2) this device must accept any interference received, including interference that may cause undesired operation.
- 3) For regulatory purposes, this product is assigned a Regulatory model number. This number should not be confused with the product name or the product number(s).

Boise, Idaho, USA

**22 December, 2005**

### For regulatory topics only:

**Australia Contact:** Product Regulations Manager, Hewlett-Packard Australia Ltd., 31-41 Joseph Street, Blackburn, Victoria 3130, Australia.

**European Contact:** Your Local Hewlett-Packard Sales and Service Office or Hewlett-Packard GmbH, Department HQ-TRE / Standards Europe, Herrenberger Strasse 140, D-71034 Böblingen, Germany (FAX: +49-7031-14-3143)

**USA Contact:** Product Regulations Manager, Hewlett-Packard Company, PO Box 15, Mail Stop 160, Boise, Idaho 83707-0015, USA (Phone: 208-396-6000)

## Country/region-specific safety statements

### Laser safety statement

The Center for Devices and Radiological Health (CDRH) of the U.S. Food and Drug Administration has implemented regulations for laser products manufactured since August 1, 1976. Compliance is mandatory for products marketed in the United States. The printer is certified as a "Class 1" laser product under the U.S. Department of Health and Human Services (DHHS) Radiation Performance Standard according to the Radiation Control for Health and Safety Act of 1968.

Since radiation emitted inside the printer is completely confined within protective housings and external covers, the laser beam cannot escape during any phase of normal user operation.



**WARNING!** Using controls, making adjustments, or performing procedures other than those specified in this user guide may result in exposure to hazardous radiation.

### Canadian DOC statement

Complies with Canadian EMC Class B requirements.

« Conforme à la classe B des normes canadiennes de compatibilité électromagnétiques (CEM). »

### Korean EMI statement

사용자 안내문 (B 급 기기)

이 기기는 비업무용으로 전자파장해검정을 받은 기기로서, 주거지역에서는 물론 모든 지역에서 사용할 수 있습니다.

### VCCI statement (Japan)

この装置は、情報処理装置等電波障害自主規制協議会（VCCI）の基準に基づくクラスB情報技術装置です。この装置は、家庭環境で使用することを目的としていますが、この装置がラジオやテレビジョン受信機に近接して使用されると、受信障害を引き起こすことがあります。  
取り扱い説明書に従って正しい取り扱いをして下さい。



## **Finnish laser statement**

### **LASERTURVALLISUUS**

#### **LUOKAN 1 LASERLAITE**

#### **KLASS 1 LASER APPARAT**

HP Color LaserJet 2605, 2605dn, 2605dtn -laserkirjoitin on käyttäjän kannalta turvallinen luokan 1 laserlaite. Normaalisissa käytössä kirjoittimen suojakotelointi estää lasersäteiden pääsyn laitteen ulkopuolelle.

Laitteen turvallisuusluokka on määritetty standardin EN60825-1 (1994) mukaisesti.

#### **VAROITUS!**

Laitteen käyttäminen muulla kuin käyttöohjeessa mainitulla tavalla saattaa altistaa käyttäjän turvallisuusluokan 1 ylittävälle näkymättömälle lasersäteilylle.

#### **VARNING!**

Om apparaten används på annat sätt än i bruksanvisning specificerats, kan användaren utsättas för osynlig laserstrålning, som överskrider gränsen för laserklass 1.

#### **HUOLTO**

HP Color LaserJet 2605, 2605dn, 2605dtn -kirjoittimen sisällä ei ole käyttäjän huollettavissa olevia kohteita. Laitteen saa avata ja huoltaa ainoastaan sen huoltamiseen koulutettu henkilö. Tällaiseksi huoltotoimenpiteeksi ei katsota väriainekasetin vaihtamista, paperiradan puhdistusta tai muita käyttäjän käsikirjassa lueteltuja, käyttäjän tehtäväksi tarkoitettuja ylläpitotoimia, jotka voidaan suorittaa ilman erikoistyökaluja.

#### **VARO!**

Mikäli kirjoittimen suojakotelo avataan, olet alttiina näkymättömälle lasersäteilylle laitteen ollessa toiminnassa. Älä katso säteeseen.

#### **VARNING!**

Om laserprinterns skyddshölje öppnas då apparaten är i funktion, utsättas användaren för osynlig laserstrålning. Betrakta ej strålen.

Tiedot laitteessa käytettävän laseriodin säteilyominaisuuksista:

Aallonpituus 770-800 nm

Teho 5 mW

Luokan 3B laser



# Index

## Symbols/Numerics

4-Color option 66, 99

## A

accessories

part numbers 176

Adaptive Halftoning options 65, 98

adding memory 168

adding paper 46

address, printer

Macintosh, troubleshooting 36

adhesive labels

specifications 14, 16

agreements, maintenance 190, 202

alerts, setting up 116

applications, settings 9

Attention light 43

automatic duplexing 58

## B

background, gray 158

bands, troubleshooting 157

battery specifications 201

bins, output

features 5

jams, clearing 152

black and white printing

selecting 54

troubleshooting 161

Black cartridge

life expectancy 128

part number 176

status gauge 43

Black Only option 66, 99

blank pages, troubleshooting 164

blinking lights 142

BOOTP 88

both sides, printing on 30, 58

built-in networking

information page, printing 110

buttons, control panel 40

## C

cables

USB, troubleshooting 164

calibrating printer 138

Cancel Job button 43, 60

cardstock

printing on 16

specifications 16

cartridge out override 134

cartridges

HP fraud hotline 130

life expectancy 128

part numbers 176

recycling 200

replacing 129

status gauge 42

status page, printing 111

status, viewing with

HP ToolboxFX 116

storage specifications 195

changing default settings 72

changing job settings 73

characters, troubleshooting 159

checking DIMM installation 172

clearing jams

common locations 148

input areas 155

inside printer 149, 150, 153

output areas 152

color

calibration 138

edge control 34

features 62

grayscale, printing as 54

halftone options 33

HP ImageREt 2400 62

managing options 33

Manual adjustment options

64, 98

matching 67

neutral grays 33

printing in grayscale 33

setting options 32

settings, changing 64

sRGB 67

troubleshooting 161

Color tab settings 31

components

locating 7

Configuration page

printing 110

configurations

AutoIP 89, 90

manual TCP/IP 89

network 77

server-based 89, 90

TCP/IP 90

configurations, printer 3

consumables

availability 202

life expectancies 128

part numbers 176

recycling 200

specifications 194

status gauge 42

status page, printing 111

contracts, maintenance 190, 202

control panel

HP ToolboxFX settings 122

lights and buttons, description

40

messages, troubleshooting 142

cover pages 29

covers 29

covers, document

cardstock, printing on 16

paper specifications 16

- using different paper for 55
- creases, troubleshooting 160
- crooked pages 159, 163
- curled media 159
- custom paper sizes 16, 54
- customer support
  - maintenance agreements 190, 202
  - repacking printer 191
  - service information form 192
- Cyan cartridge
  - life expectancy 128
  - part number 176
  - status gauge 43
- D**
- declaration of conformity 203
- default settings
  - changing 72
- default settings, restoring 56
- deleting print jobs 60
- Demo page, printing 110
- Detail halftone option 65, 98
- device discovery 84
- different first page 55
- digital cameras, color matching 67
- dimensions, printer 194
- DIMM
  - checking installation 167, 172
- display
  - control panel 40
- documentation 183
- Documentation tab, HP ToolboxFX 117
- dots per inch (dpi)
  - HP ImageREt 2400 62
  - specifications 5
- dots, troubleshooting 157
- double-sided printing 30, 31, 58
- downloading drivers 10
- dpi (dots per inch)
  - HP ImageREt 2400 62
  - specifications 5
- drivers
  - accessing 28
  - downloading 10
  - features 29, 54
  - Macintosh, troubleshooting 36
  - opening 53
  - operating systems supported 9

- presets 29
- restoring default settings 56
- settings, changing 56
- uninstalling 24
- Windows, features 20
- duplex-printing accessory
  - loading 30
- duplexing 58
- E**
- e-mail alerts, setting up 116
- Edge Control 65, 98
- electrical specifications 194
- Embedded Web server 22
- embedded Web server
  - using 123
- enabling memory
  - Windows 173
- energy consumption 194
- engine, cleaning 131
- enlarging documents 55
- envelopes
  - printing 52
  - specifications 12, 16
- environmental
  - features 200
  - paper specifications 12
  - printer specifications 195
- error messages
  - control panel 142
  - critical 145
- Event log 116
- EWS
  - printer configuration access 22
  - printer status 22
- extended warranty 190, 202
- F**
- faded print 157
- FCC statements 199
- features
  - color 62
  - drivers 29, 54
- feeding problems, troubleshooting 163
- first page, different 55
- first page, use different paper 29
- Fit to Page option 55
- flashing lights 142
- font DIMM

- installign 169
- fonts
  - PostScript 5
- 4-Color option 66, 99
- fraud hotline 130
- G**
- gateways
  - overview 89
- gray background, troubleshooting 158
- grayscale
  - troubleshooting 161
- grayscale printing
  - selecting 54
- H**
- halftone options 65, 98
- heavy paper
  - printing on 16
  - specifications 16
- Help tab, HP ToolboxFX 117
- HP built-in networking
  - information page, printing 110
- HP customer care 188
- HP fraud hotline 130
- HP ImageREt 2400 62
- HP LaserJet glossy paper
  - printing 15
- HP LaserJet paper 180
- HP LaserJet photo paper
  - media 15
- HP LaserJet Tough paper 15
- HP multipurpose paper 180
- HP Printing Supplies Returns and Recycling Program 200
- HP SupportPack 190, 202
- HP ToolboxFX
  - calibrating printer 138
  - diagnosing problems 21
  - Documentation tab 117
  - Help tab 117
  - Network Settings tab 122
  - operating systems supported 9
  - printer status information 21
  - Status tab 116
  - System Settings tab 118
  - toner level, checking from 128
- HP Web Jetadmin

- installation 23
- humidity specifications
  - paper, storing 12
  - printer environment 195
- I**
- image quality
  - HP ImageREt 2400 62
  - HP ToolboxFX settings 120
  - print, troubleshooting 156
- ImageREt 2400 62
- index printing 69
- index, photo 75
- indicator lights, printer control panel
  - error messages 142
- information pages
  - Configuration 81
  - Network configuration 81
- information pages, printing 110
- input trays
  - features 5
  - feeding problems, troubleshooting 163
  - jams, clearing 155
  - loading 46
  - media supported 16
  - part numbers 179
  - selecting 53
- installation
  - HP Web Jetadmin 23
- installing
  - Macintosh printer drivers 26
  - Macintosh software 26, 27
- installing DIMM 169
- installing memory 169
- interface ports
  - cables, ordering 178
  - types included 5
- Internet protocol (IP)
  - overview 86
- IP address
  - BOOTP 88
  - class 87
  - host portion 87
  - Macintosh, troubleshooting 36
  - network portion 87
  - overview 86
  - structure 87
- IP addressing 85
- J**
- jams
  - causes of 148
  - duplex area 150
  - input areas 155
  - inside printer 149, 150
  - output areas 152
  - top output area 153
  - top output bin 153
- job settings
  - changing 73
- K**
- keys, control panel 40
- L**
- labels
  - specifications 14, 16
- language
  - information pages 110
- language-font DIMM
  - enabling 174
- laser safety statements 204
- LaserJet paper 180
- letterhead
  - printing 15
- life expectancies, supplies 128
- light print, troubleshooting 157
- lightness
  - faded print, troubleshooting 157
- lights
  - locating 40
- lines, troubleshooting
  - printed pages 157
- loading media
  - tray 1 46
  - tray 2 47
- loose toner, troubleshooting 158
- M**
- Macintosh
  - drivers 9
  - drivers, accessing 28
  - drivers, troubleshooting 36
  - features supported 9
  - printer software 25
  - problems, troubleshooting 36
  - USB card, troubleshooting 37
- Macintosh Configure Device 35
- Macintosh configure device
  - using 35
- Macintosh Installer
  - operating systems supported 9
- Magenta cartridge
  - life expectancy 128
  - part number 176
  - status gauge 43
- mailing labels
  - specifications 14, 16
- maintenance
  - agreements 190, 202
  - replacing print cartridges 128
- managing network 80
- Manual color options 64, 98
- manual duplexing 58
- manuals 183
- margins, envelopes 12
- matching, color 67
- Material Safety Data Sheet 202
- media
  - cardstock 16
  - curled, troubleshooting 159
  - custom-sized 16, 54
  - envelopes 12, 52
  - first page 29
  - first page, different 55
  - HP LaserJet glossy paper 15
  - HP LaserJet photo paper 15
  - HP ToolboxFX settings 121
  - HP, ordering 180
  - jams 148
  - labels 14
  - letterhead 15
  - loading trays 46
  - pages per sheet 30
  - selecting 11
  - specifications 11
  - transparencies 15
  - tray 1, types supported 16
  - tray 2, types supported 16
  - tray 3, types supported 16
  - troubleshooting 162
  - wrinkled 160
- memory
  - enabling 32, 167, 173
  - installation 167
  - installing 169
  - slots 6
  - working with 167
- memory cards

- changing job settings 73
- memory cards insertion 69
- memory cards, photo
  - inserting 70
- mercury specifications 201
- messages
  - control panel 142
- messages, error 142
- messaging and management,
  - network 84
- monitors, color matching 67
- multiple pages per sheet 30, 55
- multipurpose paper, HP 180

**N**

- N-up printing 55
- n-up printing 30
- network
  - AutoIP configuration 89, 90
  - configuration 77
  - configuring 77
  - device discovery 84
  - IP address 100
  - IP addressing 85
  - manual TCP/IP configuration 89
  - messaging and management 84
  - printer control panel 77
  - printer set up 100
  - server-based configuration 89, 90
  - static IP address 100
  - supported protocols 77, 84
  - TCP/IP configuration 89
  - TCP/IP configuration tools 90
  - troubleshooting 77
  - using printer control panel 81
- network configuration
  - direct printing 78
  - making changes 79
  - shared printing 79
- Network configuration page 81
- network password
  - changing 80
  - setting 80
- network settings
  - changing 80
  - viewing 80

- Network Settings tab,
  - HP ToolboxFX 122
- network setup 78
- networks
  - information pages, printing 110
- Neutral Grays options 66, 99
- non-HP print cartridges 129

**O**

- on-site service agreements 202
- online customer support 188
- operating environment,
  - specifications 195
- operating systems supported 9
- ordering accessories
  - information 175
- ordering supplies and accessories 176
- output bin
  - features 5
- output bin extender 7
- output bins
  - jams, clearing 152
- output quality
  - HP ImageREt 2400 62
  - HP ToolboxFX settings 120
  - print, troubleshooting 156
- overhead transparencies
  - specifications 15, 16
- ozone specifications 200

**P**

- packaging printer 191
- Page Setup 53
- pages
  - blank 164
  - not printing 164
  - printing slowly 164
  - skewed 159, 163
- pages per minute 5
- pages per sheet 30, 55
- paper
  - cardstock 16
  - curled, troubleshooting 159
  - custom-sized 16, 54
  - first page 29
  - first page, different 55
  - HP LaserJet Tough paper 15
  - HP ToolboxFX settings 121
  - HP, ordering 180

- jams 148
- letterhead 15
- loading trays 46
- pages per sheet 30
- selecting 11
- specifications 11
- tray 1, types supported 16
- tray 2, types supported 16
- tray 3, types supported 16
- troubleshooting 162
- wrinkled 160
- paper input trays
  - features 5
  - feeding problems,
    - troubleshooting 163
  - jams, clearing 155
  - loading 46
  - media supported 16
  - part numbers 179
  - selecting 53
- paper output bin
  - features 5
- paper output bins
  - jams, clearing 152
- part numbers
  - accessories 175
- parts
  - part numbers 176
  - user replaceable 182
- paused printing 43
- phone numbers
  - HP fraud hotline 130
  - HP Printing Supplies Returns and Recycling Program 201
  - support 188
- photo 69
- photo index 69
- photo memory cards 6
- photo printing 69
- photos
  - memory cards, inserting 70
  - printing an index 75
  - printing directly from the
    - memory card 74
- pick-up rollers, ordering 182
- platforms supported 9
- ports
  - cables, ordering 178
  - troubleshooting Macintosh 37
  - types included 5

- PostScript driver, HP ToolboxFX settings 120
- power
  - requirements 194
- preprinted paper
  - printing on 15
- presets 29
- print cartridge
  - replacing 105, 135
- print cartridges
  - HP fraud hotline 130
  - life expectancy 128
  - part numbers 176
  - recycling 200
  - replacing 129
  - status gauge 42
  - status page, printing 111
  - status, viewing with
    - HP ToolboxFX 116
  - storage specifications 195
- Print dialog box 53
- print media
  - specifications 11
- print media specifications 11
- print quality
  - HP ImageREt 2400 62
  - HP ToolboxFX settings 120
  - specifications 5
  - troubleshooting 156
- print servers
  - information page, printing 110
- printer
  - drivers 28
- printer drivers
  - downloading 10
  - features 54
  - Macintosh 26
  - opening 53
  - operating systems supported 9
  - restoring default settings 56
  - settings, changing 56
  - uninstalling 24
  - Windows, features 20
- printer memory
  - addition 168
- printer software
  - Macintosh 25
- printing
  - both sides 58
  - canceling 60
- photos, from the memory card 74
- photos, index of 75
- troubleshooting 164
- Windows 56
- printing environment 84
- programs, settings 9

**Q**

- quality
  - HP ImageREt 2400 62
  - HP ToolboxFX settings 120
  - print, troubleshooting 156
  - specifications 5
- Quick Sets 55

**R**

- Ready light 43
- rear output door
  - features 5
- recycling
  - plastics 200
  - print cartridges 200
- reducing documents 55
- refilled print cartridges 129
- refilling paper 46
- regulatory statements
  - declaration of conformity 203
  - FCC 199
  - laser safety 204
  - Material Safety Data Sheet 202
- repacking printer 191
- repetitive defects, troubleshooting 160
- replacing print cartridges 129
- reports, printer
  - Configuration page 81
  - Network configuration page 81
- reports, printing 110
- resizing documents 55
- resolution
  - HP ImageREt 2400 62
  - specifications 5
- restoring default settings 56
- resuming printing 43
- RGB color options 65, 67, 99
- rollers, ordering 182

**S**

- saving settings 55
- scaling documents 55
- scanners, color matching 67
- scatter, troubleshooting 160
- screen color matching 67
- selection guidelines
  - media 11
- separation pad, ordering 182
- servers
  - information page, printing 110
- service
  - agreements 190, 202
  - HP ToolboxFX settings 122
  - information form 192
  - part numbers 176
  - repacking printer 191
- set up
  - printer 100
- settings
  - changing 9, 56
  - color 64
  - Configuration page 81
  - driver presets 29
  - HP ToolboxFX 118
  - Network configuration page 81
  - restoring defaults 56
  - saving 55
- shipping printer 191
- size, printer 194
- sizes, media
  - custom 16, 54
  - selecting trays 53
- skewed pages 159, 163
- slots
  - memory 6
- smeared toner, troubleshooting 158
- Smooth halftone option 65, 98
- software
  - downloading 10
  - features 54
  - HP ToolboxFX 115
  - Macintosh 26
  - Macintosh Configure Device 35
  - operating systems supported 9
  - settings, changing 56
  - uninstalling 24
  - Windows, features 20
- source, printing by 53
- special media
  - cardstock 16

- custom-sized 16, 54
- envelopes 12, 52
- HP LaserJet glossy paper 15
- labels 14
- letterhead 15
- specifications 16
- transparencies 15
- specifications
  - envelopes 12
  - environmental 195
  - labels 14
  - Material Safety Data Sheet 202
  - paper 11
  - printer 194
  - printer features 5
  - transparencies 15
  - trays, media supported 16
- specks, troubleshooting 157
- speed
  - specifications 5
- spots, troubleshooting 157
- sRGB 65, 67, 99
- static IP address 100
- status
  - alerts, HP ToolboxFX 116
  - Supplies Status page, printing 111
  - viewing with HP ToolboxFX 116
- Status tab, HP ToolboxFX 116
- stopping printing 60
- storing
  - envelopes 13
  - paper 12
  - print cartridges 129
  - printer 195
- streaks, troubleshooting 157
- subnet mask
  - overview 88
- subnets
  - overview 88
- Supplementary Documentation
  - part numbers 175
- supplies
  - availability 202
  - life expectancies 128
  - recycling 200
  - specifications 194
  - status gauge 42
  - status page 111
  - status, viewing with
    - HP ToolboxFX 116
  - supplies and consumables
    - part numbers 175
  - support
    - maintenance agreements 190, 202
    - part numbers 176
    - repacking printer 191
    - service information form 192
  - supported network protocols 84
  - SupportPack, HP 190, 202
  - System Settings tab,
    - HP ToolboxFX 118
- T**
  - TCP/IP configuration 89
  - technical support
    - maintenance agreements 190, 202
    - part numbers 176
    - repacking printer 191
    - service information form 192
  - telephone numbers
    - HP fraud hotline 130
    - HP Printing Supplies Returns and Recycling Program 201
    - support 188
  - temperature specifications
    - paper, storing 12
    - printer environment 195
  - text, troubleshooting
    - misformed characters 159
  - toner
    - loose, troubleshooting 158
    - scatter, troubleshooting 160
    - smear, troubleshooting 158
    - specks, troubleshooting 157
    - status gauge 42
  - Toolbox. *See* HP ToolboxFX
  - ToolboxFX
    - operating systems supported 9
  - top output bin
    - features 5
  - Transmission Control Protocol (TCP)
    - overview 86
  - transparencies
    - specifications 15, 16
  - Trapping options 65, 98
- tray 1
  - loading 46
- tray 2
  - loading 47
- tray 3
  - loading 47
  - part number 179
- trays
  - double-sided printing 31
  - features 5
  - feeding problems,
    - troubleshooting 163
  - jams, clearing 155
  - loading 46
  - media supported 16
  - part numbers 179
  - selecting 53
- troubleshooting
  - blank pages 164
  - calibrating printer 138
  - color 161
  - Configuration page, printing 81, 110
  - control panel messages 142
  - curled media 159
  - Demo page, printing 110
  - faded print 157
  - feeding problems 163
  - jams 148
  - lines, printed pages 157
  - loose toner 158
  - Macintosh problems 36
  - Network configuration page,
    - printing 81
  - pages not printing 164
  - pages printing slowly 164
  - paper 162
  - print quality 156
  - repetitive defects 160
  - replacing print cartridges 129
  - skewed pages 159, 163
  - text 159
  - toner scatter 160
  - toner smear 158
  - toner specks 157
  - USB cables 164
  - wrinkles 160
- two-sided printing 30, 58
- types, media
  - HP ToolboxFX settings 121



selecting trays by 53

life expectancy 128

part number 176

status gauge 43

## U

uninstalling

Macintosh software 27

uninstalling software

using Windows OS 24

Windows 24

USB port

troubleshooting 164

troubleshooting Macintosh 37

type included 5

User Datagram Protocol (UDP)

overview 86

user guide

part numbers 183

user replaceable parts 182

user-replaceable parts 175

## V

vertical lines, troubleshooting 157

voltage requirements 194

## W

warranty

extended 190, 202

print cartridge 187

product 185, 186

watermarks

cover page 29

wavy paper, troubleshooting 159

Web site address

HP Web Jetadmin 23

websites

customer support 188

HP Printing Supplies Returns

and Recycling Program 201

Material Safety Data Sheet 202

weight

printer 194

Windows

driver features 54

enabling memory 173

printing from 56

settings 57

uninstalling software 24

versions supported 9

wrinkles, troubleshooting 160

## Y

Yellow cartridge





© 2006 Hewlett-Packard Development Company, L.P.

[www.hp.com](http://www.hp.com)



Q7821-90906